

Contents

RULES FOR THE SURVEY AND CONSTRUCTION OF STEEL SHIPS	11
Part C HULL CONSTRUCTION AND EQUIPMENT	11
Part 2-1 CONTAINER CARRIERS	11
Chapter 1 GENERAL.....	11
1.1 General.....	11
1.2 Definitions	11
Chapter 2 GENERAL ARRANGEMENT DESIGN	13
2.1 Structural Arrangements	13
Chapter 3 STRUCTURAL DESIGN PRINCIPLES	14
3.1 Net Scantling Approach.....	14
3.2 Loading Manual and Loading Instruments	14
3.3 Lashing Software	14
Annex 3.1 REQUIREMENTS FOR LASHING SOFTWARE	16
An1. General.....	16
An2. Operation Manual	16
An3. Functional Requirements	16
An4. Test Loading Conditions	17
An5. Approval of Lashing Software	17
An6. Acceptable Tolerances.....	17
An7. Other Requirements.....	18
Chapter 4 LOADS	19
4.1 General.....	19
4.3 Loads to be Considered in Local Strength.....	27
4.4 Loads to be Considered in Strength of Primary Supporting Structures	28
4.5 Loads to be Considered in Strength Assessment by Cargo Hold Analysis	30
4.6 Loads to be Considered in Fatigue.....	34
Chapter 5 LONGITUDINAL STRENGTH	38
5.1 General.....	38
5.2 Yield Strength Assessment.....	39
5.3 Buckling Strength Assessment	40
5.4 Hull Girder Ultimate Strength	40
5.5 Torsional Strength	41
Annex 5.3 BUCKLING STRENGTH ASSESSMENT RELATING TO LONGITUDINAL STRENGTH (UR S11A).....	51
An1. General.....	52
An2. Buckling Strength Assessment of Each Structural Member.....	52
Annex 5.4 HULL GIRDER ULTIMATE STRENGTH ASSESSMENT CONSIDERING THE EFFECT OF LATERAL LOADS.....	64
An1. General.....	64

An2. Evaluation Method of Hull Girder Ultimate Strength Considering the Effect of Lateral Loads	64
Chapter 7 STRENGTH OF PRIMARY SUPPORTING STRUCTURES	70
7.1 General.....	70
7.2 Double Hull Structure	70
7.3 Deck Construction.....	71
Chapter 8 STRENGTH ASSESSMENT BY CARGO HOLD ANALYSIS	73
8.1 General.....	73
8.2 Evaluation Area and Members to be Assessed	73
8.3 Structural Models	73
8.4 Considerations for Corrosion.....	74
8.5 Boundary Conditions and Loads Conditions	74
8.6 Strength Assessment	77
Chapter 9 FATIGUE.....	79
9.1 General.....	79
9.2 Hot Spots to Assess	79
9.3 Fatigue Strength Assessment of Longitudinal End Connections	80
9.4 Torsional Fatigue Strength Assessment	81
9.5 Detailed Design Standards.....	86
Chapter 10 ADDITIONAL STRUCTURAL REQUIREMENTS.....	87
10.1 Bottom Structure.....	87
10.2 Side Structure	87
10.3 Deck Structure	87
10.4 Bulkhead Structure.....	87
10.5 Special Requirements for Container Carriers Applying Extremely Thick Steel Plates.....	87
Chapter 12 WELDING.....	91
12.1 Container Carrier Welding.....	91
Chapter 14 EQUIPMENT.....	92
14.1 Small Hatchways	92
14.2 Container Securing Systems	92
Part 2-2 BOX-SHAPED BULK CARRIERS.....	95
Chapter 1 GENERAL.....	95
1.1 General.....	95
1.2 Definitions	95
Chapter 2 GENERAL ARRANGEMENT DESIGN	97
2.1 Structural Arrangements	97
Chapter 3 STRUCTURAL DESIGN PRINCIPLES	98
3.1 (Deleted).....	98
3.2 Loading Manual and Loading Instruments	98
Chapter 4 LOADS	99
4.1 General.....	99
4.2 Loads to be Considered in Longitudinal Strength	100
4.3 Loads to be Considered in Local Strength.....	100

4.4	Loads to be Considered in Strength of Primary Supporting Structures	101
4.5	Loads to be Considered in Strength Assessment by Cargo Hold Analysis	105
4.6	Loads to be Considered in Fatigue.....	108
4.7	Loads to be Considered in Additional Structural Requirements	109
Annex 4.5	OPERATIONAL LOADING CONDITIONS AND ANALYTICAL LOADING CONDITIONS	111
An1.	General.....	111
An2.	Operational Loading Conditions and Analytical Loading Conditions	111
Chapter 5	LONGITUDINAL STRENGTH	121
5.1	Torsional Strength	121
5.2	Hull Girder Ultimate Strength	123
Chapter 6	LOCAL STRENGTH	124
6.1	Ships Loaded with Special Cargo.....	124
6.2	Transverse Bulkheads	124
Chapter 7	STRENGTH OF PRIMARY SUPPORTING STRUCTURES	125
7.1	General.....	125
Chapter 8	STRENGTH ASSESSMENT BY CARGO HOLD ANALYSIS	126
8.1	General.....	126
8.2	Evaluation Area and Members to be Assessed	126
8.3	Structural Models	126
8.4	Boundary Conditions and Loads Conditions	127
8.5	Strength Assessment	129
Chapter 9	FATIGUE.....	131
9.1	General.....	131
9.2	Structural Details to be Assessed	131
9.3	Loading Conditions and Fraction of Time to be Considered	131
9.4	Boundary Conditions and Load Conditions.....	132
9.5	Detailed Design Standards.....	132
Chapter 10	ADDITIONAL STRUCTURAL REQUIREMENTS.....	133
10.1	Bottom Structure.....	133
10.2	Side Structure	133
10.3	Bulkhead Structure.....	134
10.4	Deck Structure	134
10.5	Requirements for GRAB Notation	134
10.6	Other	135
Annex 1.1	ADDITIONAL REQUIREMENTS FOR BULK CARRIERS IN CHAPTER XII OF THE SOLAS CONVENTION	136
An1.	General.....	136
An2.	Damage Stability.....	137
An3.	Transverse Watertight Bulkheads in Cargo Holds	138
An4.	Allowable Hold Loading on Double Bottom	148
An5.	Longitudinal Strength in Flooded Condition.....	152
An6.	Double-side Skin Construction and Cargo Hold Construction.....	154

Part 2-3	ORE CARRIERS	162
Chapter 1	GENERAL.....	162
1.1	General.....	162
1.2	Definitions	162
Chapter 2	GENERAL ARRANGEMENT DESIGN	164
2.1	Structural Arrangements	164
Chapter 3	STRUCTURAL DESIGN PRINCIPLES	165
3.1	(Deleted).....	165
3.2	Loading Manual and Loading Instruments	165
Chapter 4	LOADS	176
4.1	General.....	176
4.2	Loads to be Considered in Local Strength.....	176
4.3	Loads to be Considered in Strength Assessment by Cargo Hold Analysis	177
4.4	Loads to be Considered in Fatigue.....	181
Chapter 8	STRENGTH ASSESSMENT BY CARGO HOLD ANALYSIS	183
8.1	General.....	183
8.2	Evaluation Area and Members to be Assessed	183
8.3	Structural Models	183
8.4	Boundary Conditions and Loads Conditions	184
8.5	Strength Assessment	184
Chapter 9	FATIGUE.....	186
9.1	General.....	186
9.2	Structural Details to be Assessed	186
9.3	Loading Conditions and Fraction of Time to be Considered	186
9.4	Boundary Conditions and Load Conditions.....	187
Chapter 10	ADDITIONAL STRUCTURAL REQUIREMENTS.....	188
10.1	Bottom Structure.....	188
10.2	Side Structure	188
10.3	Deck Structure	189
10.4	Bulkhead Structure.....	189
10.5	Tank Structures for Sloshing	189
10.6	Other	191
Chapter 11	STRUCTURES OUTSIDE THE CARGO REGION	192
11.1	Superstructures.....	192
Part 2-4	WOOD CHIP CARRIERS	193
Chapter 1	GENERAL.....	193
1.1	General.....	193
1.2	Definitions	193
Chapter 2	GENERAL ARRANGEMENT DESIGN	195
2.1	Structural Arrangements	195
Chapter 3	STRUCTURAL DESIGN PRINCIPLES	196
3.1	Minimum Requirements.....	196
3.2	Loading Manual and Loading Instruments	196

Chapter 4	LOADS	197
4.1	General.....	197
4.2	Loads to be Considered in Local Strength.....	197
4.3	Loads to be Considered in Strength Assessment by Cargo Hold Analysis	198
4.4	Loads to be Considered in Fatigue.....	201
Chapter 5	LONGITUDINAL STRENGTH	203
5.1	Hull Girder Ultimate Strength	203
Chapter 6	LOCAL STRENGTH	204
6.1	General.....	204
6.2	Ballast Holds	204
6.3	Bilge Hopper Tanks	204
Chapter 8	STRENGTH ASSESSMENT BY CARGO HOLD ANALYSIS	205
8.1	General.....	205
8.2	Evaluation Area and Members to be Assessed	205
8.3	Structural Models	205
8.4	Boundary Conditions and Loads Conditions	206
8.5	Strength Assessment	206
Chapter 9	FATIGUE.....	207
9.1	General.....	207
9.2	Structural Details to be Assessed	207
9.3	Loading Conditions and Fraction of Time to be Considered	207
9.4	Boundary Conditions and Load Conditions.....	208
9.5	Detailed Design Standards.....	208
Chapter 10	ADDITIONAL STRUCTURAL REQUIREMENTS.....	211
10.1	Bottom Structure.....	211
10.2	Side Structure	211
10.3	Bulkhead Structure.....	212
10.4	Deck Structure	212
10.5	Other	212
Part 2-5	GENERAL CARGO SHIPS AND REFRIGERATED CARGO SHIPS.....	213
Chapter 1	GENERAL.....	213
1.1	General.....	213
1.2	Definitions	213
Chapter 3	STRUCTURAL DESIGN PRINCIPLES	215
3.1	(Deleted).....	215
3.2	Loading Manuals and Loading Instruments.....	215
Chapter 4	LOADS	216
4.1	General.....	216
4.2	Loads to be Considered in Local Strength.....	216
4.3	Loads to be Considered in Strength of Primary Supporting Structures	217
4.4	Loads to be Considered in Additional Structural Requirements	218
Chapter 6	LOCAL STRENGTH	225
6.1	General.....	225

6.2	Ships Loaded with Special Cargo.....	226
Chapter 7	STRENGTH OF PRIMARY SUPPORTING STRUCTURES	227
7.1	General.....	227
7.2	Simple Girders.....	228
7.3	Double Hull Structures.....	229
7.4	Special Cargo.....	229
Chapter 10	ADDITIONAL STRUCTURAL REQUIREMENTS.....	230
10.1	Ships Carrying Steel Coils.....	230
10.2	Ships Loaded with Containers	235
10.3	Bulkhead Structures.....	235
10.4	Ships Loaded with Lumber	236
10.5	Additional Requirements for Self-Unloading Ships.....	238
Part 2-6	VEHICLES CARRIERS AND ROLL-ON/ROLL-OFF SHIPS.....	239
Chapter 1	GENERAL.....	239
1.1	General.....	239
1.2	Definitions	239
Chapter 3	STRUCTURAL DESIGN PRINCIPLES	240
3.1	Minimum Requirements.....	240
3.2	Loading Manual and Loading Computer.....	241
Chapter 4	LOADS	242
4.1	General.....	242
4.2	Loads to be Considered in Local Strength.....	242
4.3	Loads to be Considered in Strength of Primary Supporting Structures	243
4.4	Loads to be Considered in Strength Assessment of the Bottom Construction by Whole Ship Analysis.....	244
4.5	Loads to be Considered in Racking Strength Assessment by Whole Ship Analysis.....	248
4.6	Loads to be Considered in Fatigue Strength Assessment by Whole Ship Analysis	249
4.7	Loads to be Considered in Additional Structural Requirements	251
Chapter 6	LOCAL STRENGTH	253
6.1	General.....	253
Chapter 7	STRENGTH OF PRIMARY SUPPORTING STRUCTURES	254
7.1	General.....	254
7.2	Simple Girders.....	255
Chapter 8	STRENGTH ASSESSMENT BY CARGO HOLD ANALYSIS	257
8.1	General.....	257
8.2	Structural Models	258
8.3	Consideration for Corrosion	259
8.4	Strength Assessment of the Bottom Construction.....	259
8.5	Racking Strength Assessment.....	261
Chapter 9	FATIGUE.....	264
9.1	General.....	264
9.2	Structural Details to be Assessed	264
9.3	Loading Conditions and Fraction of Time to be Considered	265

9.4	Boundary Conditions and Load Conditions.....	265
Chapter 10	ADDITIONAL STRUCTURAL REQUIREMENTS.....	269
10.1	Car Deck	269
10.2	Movable Car Deck	272
Chapter 12	WELDING.....	275
12.1	Additional Requirements for Joints at Specific Locations	275
Part 2-7	TANKERS.....	278
Chapter 1	GENERAL.....	278
1.1	General.....	278
1.2	Definitions	278
Chapter 2	GENERAL ARRANGEMENT DESIGN	280
2.1	Structural Arrangements	280
Chapter 4	LOADS	282
4.1	General.....	282
4.2	Loads to be Considered in Local Strength.....	282
4.3	Loads to be Considered in Strength of Primary Supporting Structures	283
4.4	Loads to be Considered in Strength Assessment by Cargo Hold Analysis	286
4.5	Loads to be Considered in Fatigue.....	288
Chapter 6	LOCAL STRENGTH	290
6.1	Independent Prismatic Tanks	290
Chapter 7	STRENGTH OF PRIMARY SUPPORTING STRUCTURES	293
7.1	General.....	293
7.2	Independent Prismatic Tanks	294
Chapter 8	STRENGTH ASSESSMENT BY CARGO HOLD ANALYSIS	295
8.1	General.....	295
8.2	Evaluation Area and Members to be Assessed	295
8.3	Structural Models	295
8.4	Boundary Conditions and Loads Conditions	296
8.5	Strength Assessments.....	296
Chapter 9	FATIGUE.....	297
9.1	General.....	297
9.2	Structural Details to be Assessed	297
9.3	Loading Conditions and Fraction of Time to be Considered	297
9.4	Boundary Conditions and Load Conditions.....	298
9.5	Detailed Design Standards.....	298
Chapter 10	ADDITIONAL STRUCTURAL REQUIREMENTS.....	300
10.1	General.....	300
Chapter 12	WELDING.....	301
12.1	Welding in Tankers	301
Chapter 14	EQUIPMENT.....	302
14.1	Special Requirements for Hatch Covers	302
14.2	Special Requirements for Freeing Arrangements.....	303

Part 2-8 SHIPS CARRYING LIQUEFIED GASES IN BULK (INDEPENDENT SPHERICAL TANKS OF TYPE B).....	304
Chapter 1 GENERAL.....	304
1.1 General.....	304
1.2 Definitions	304
Chapter 3 STRUCTURAL DESIGN PRINCIPLES	305
3.1 Loading Manual and Loading Instrument	305
Chapter 4 LOADS	306
4.1 General.....	306
4.2 Loads to be Considered in Local Strength.....	306
4.3 Loads to be Considered in Strength Assessment by Cargo Hold Analysis	306
4.4 Loads to be Considered in Fatigue.....	310
Chapter 5 LONGITUDINAL STRENGTH	312
5.1 Hull Girder Ultimate Strength	312
Chapter 7 STRENGTH OF PRIMARY SUPPORTING STRUCTURES	313
7.1 General.....	313
Chapter 8 STRENGTH ASSESSMENT BY CARGO HOLD ANALYSIS	314
8.1 General.....	314
8.2 Evaluation Area and Members to be Assessed	314
8.3 Structural Models	315
8.4 Boundary Conditions and Loads Conditions	315
Chapter 9 FATIGUE.....	319
9.1 General.....	319
9.2 Structural Details to be Assessed	319
9.3 Loading Conditions and Time Ratios to Consider	320
9.4 Boundary Conditions and Load Conditions.....	320
Part 2-9 SHIPS CARRYING LIQUEFIED GASES IN BULK (INDEPENDENT PRISMATIC TANKS TYPE A/B) 322	
Chapter 1 GENERAL.....	322
1.1 General.....	322
1.2 Definitions	323
1.3 Plans and Documents to be Submitted.....	326
Chapter 3 STRUCTURAL DESIGN PRINCIPLES	327
3.1 Loading Manual and Loading Computer.....	327
Chapter 4 LOADS	328
4.1 General.....	328
4.2 Loads to be Considered in Local Strength.....	328
4.3 Loads to be Considered in Strength Assessment by Cargo Hold Analysis	330
4.4 Loads to be Considered in Fatigue.....	347
Annex 4.3 OPERATIONAL LOADING CONDITIONS AND ANALYTICAL LOADING CONDITIONS	353
An1. General.....	353
An2. Operational Loading Condition and Analytical Loading Condition	353

Chapter 5	LONGITUDINAL STRENGTH	361
5.1	Hull Girder Ultimate Strength	361
Chapter 6	LOCAL STRENGTH	362
6.1	Independent Prismatic Tanks	362
Chapter 7	STRENGTH OF PRIMARY SUPPORTING STRUCTURES	364
7.1	General.....	364
Chapter 8	STRENGTH ASSESSMENT BY CARGO HOLD ANALYSIS	365
8.1	General.....	365
8.2	Evaluation Area and Members to be Assessed	367
8.3	Structural Models	368
8.4	Boundary Conditions and Loads Conditions	369
8.5	Strength Assessment	369
8.6	Strength Assessment by Local Structural Analysis	371
Chapter 9	FATIGUE.....	379
9.1	General.....	379
9.2	Hot Spots to be Assessed	380
9.3	Loading Conditions and Fraction of Time to be Considered	382
9.4	Finite Element Analysis	383
9.5	Boundary Conditions and Load Conditions.....	386
9.6	Fatigue Strength Assessment	386
Chapter 10	ADDITIONAL STRUCTURAL REQUIREMENTS.....	387
10.1	Tank Structures for Sloshing	387
Part 2-10 C)	SHIPS CARRYING LIQUEFIED GASES IN BULK (INDEPENDENT TANKS OF TYPE 391	
Chapter 1	GENERAL.....	391
1.1	General.....	391
1.2	Definitions	391
Chapter 4	LOADS	393
4.1	General.....	393
4.2	Loads to be Considered in Local Strength.....	393
4.3	Loads to be Considered in Strength of Primary Supporting Structures	393
Chapter 5	LONGITUDINAL STRENGTH	395
5.1	Hull Girder Ultimate Strength	395
Chapter 7	STRENGTH OF PRIMARY SUPPORTING STRUCTURES.....	396
7.1	General.....	396
Chapter 8	STRENGTH ASSESSMENT BY CARGO HOLD ANALYSIS	398
8.1	General.....	398
Part 2-11	SHIPS CARRYING LIQUEFIED GASES IN BULK (MEMBRANE TANKS).....	399
Chapter 1	GENERAL.....	399
1.1	General.....	399
1.2	Definitions	399
1.3	Plans and Documents To Be Submitted	400
Chapter 3	STRUCTURAL DESIGN PRINCIPLES	401

3.1	Loading Manual and Loading Instruments	401
Chapter 4	LOADS	402
4.1	General.....	402
4.2	Loads to be Considered in Local Strength.....	402
4.3	Loads to be Considered in Strength Assessment by Cargo Hold Analysis	403
4.4	Loads to be Considered in Fatigue.....	411
4.5	Loads to be Considered in Additional Structural Requirements	413
Chapter 5	LONGITUDINAL STRENGTH	416
5.1	Hull Girder Ultimate Strength	416
Chapter 7	STRENGTH OF PRIMARY SUPPORTING STRUCTURES	417
7.1	General.....	417
Chapter 8	STRENGTH ASSESSMENT BY CARGO HOLD ANALYSIS	418
8.1	General.....	418
8.2	Evaluation Area and Members to be Assessed	418
8.3	Structural Models	419
8.4	Boundary Conditions and Loads Conditions	419
8.5	Strength Assessment	419
Chapter 9	FATIGUE.....	421
9.1	General.....	421
9.2	Structural Details to be Assessed	421
9.3	Loading Conditions and Fraction of Time to be Considered	421
9.4	Boundary Conditions and Load Conditions.....	422
Chapter 10	ADDITIONAL STRUCTURAL REQUIREMENTS.....	423
10.1	Special Requirements for Inner Hull Members	423
10.2	Tank Structures for Sloshing	423

RULES FOR THE SURVEY AND CONSTRUCTION OF STEEL SHIPS

Part C HULL CONSTRUCTION AND EQUIPMENT

Part 2-1 CONTAINER CARRIERS

Chapter 1 GENERAL

1.1 General

1.1.1 Application

1.1.1.1 Application of this Part

1 The hull construction and equipment of ships intended to be registered as container carriers, affixed with the notation “*Container Carrier*” (abbreviated as *CNC*), are to be in accordance with the requirements in **Part 2-1** in addition to **Part 1**.

2 The requirements in **Part 2-1** are for ships which are intended solely for the carriage of containers and which have large openings in the deck, double bottoms in cargo holds, and decks and bottoms framed longitudinally.

3 Container carriers with a different construction from that specified in -2 above, to which the requirements in this Part are considered to be not applicable, are to be at the discretion of the Society.

1.2 Definitions

1.2.1 Naming Convention

1.2.1.1 Structural Nomenclature

Fig. 1.2.1-1 show the common structural nomenclature used in **Part 2-1**.

Fig. 1.2.1-1 Container Carriers

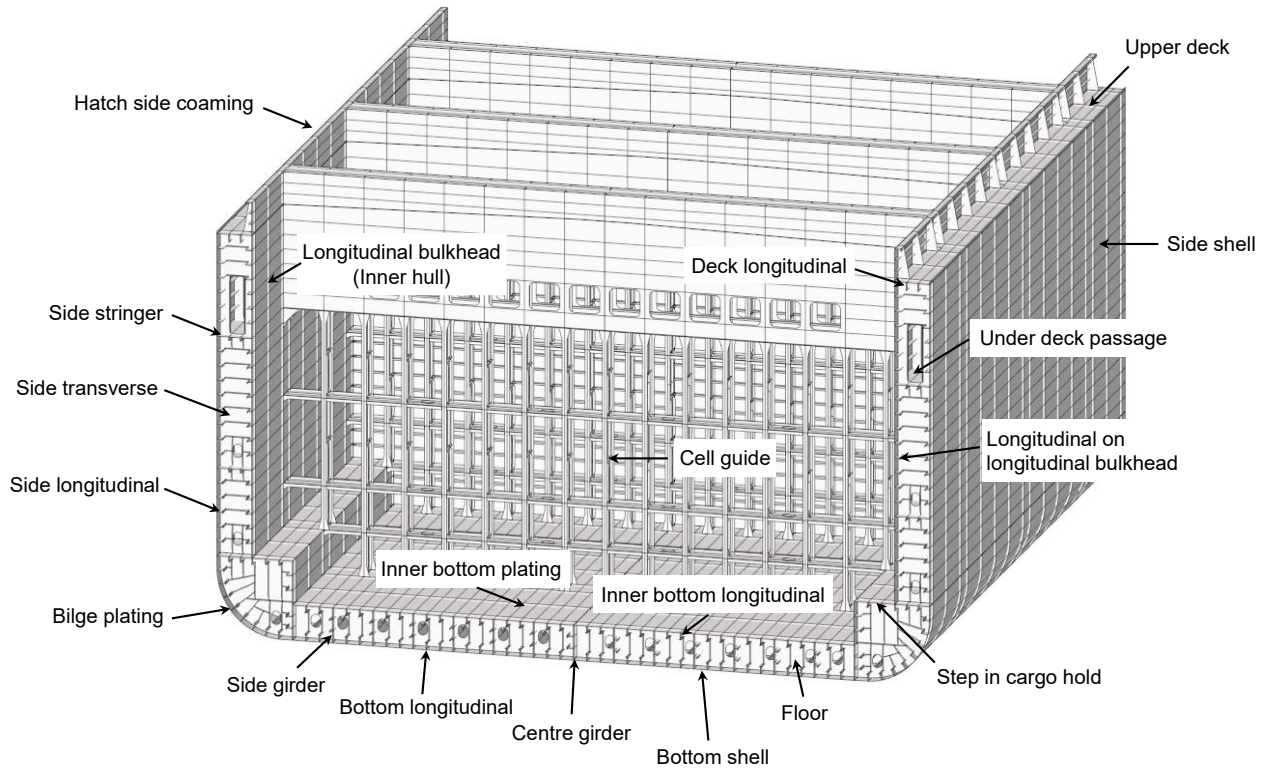

Chapter 2 GENERAL ARRANGEMENT DESIGN

2.1 Structural Arrangements

2.1.1 Double Bottoms

2.1.1.1 General

Side girders or floors are to be provided in the double bottoms under corner fittings, or double bottoms are to be constructed so as to effectively support the loads of the containers.

2.1.2 Double Side Construction

2.1.2.1 General

1 The side construction of holds is to be of double hull construction as far as practicable and is to be thoroughly stiffened by providing side transverses and side stringers within the double hull.

2 Side transverses are to be provided at floors in double bottoms.

Chapter 3 STRUCTURAL DESIGN PRINCIPLES

3.1 Net Scantling Approach

3.1.1 Corrosion Addition

3.1.1.1

1 The corrosion addition when applying 5.1 to 5.4 is to be in accordance with this 3.1.1 instead of 3.3.4.2, Part 1.

2 Corrosion additions for carbon-manganese steels are to be in accordance with the following (1) and (2):

(1) The total corrosion addition for both sides of the structural member, t_C , is to be obtained from the following formula:

$$t_C = \text{Roundup}_{0.5}(t_{c1} + t_{c2}) + t_{res} \text{ (mm)}$$

(2) For an internal member within a given compartment, the total corrosion addition is to be obtained from the following formula:

$$t_C = \text{Roundup}_{0.5}(2t_{c1}) + t_{res} \text{ (mm)}$$

Table 3.1.1-1 Corrosion Addition for One Side of a Structural Member

Compartment type	One side corrosion addition t_{c1} , t_{c2} (mm)
Exposed to sea water	1.0
Exposed to atmosphere	1.0
Ballast tanks	1.0
Void and dry spaces	0.5
Fresh water, fuel oil and lube oil tanks	0.5
accommodation space	0.0
Container holds	1.0
Compartment types not mentioned above	0.5

3.2 Loading Manual and Loading Instruments

3.2.1 Loading Instruments

3.2.1.1 General

The loading instruments are to be able to easily calculate the still water torsional moment at the specified calculation point and confirm that it does not exceed the specified permissible value.

3.2.1.2 Function

The loading instruments are to satisfy the following functions.

- (1) Still water torsional moment is to be outputted at the forward end transverse bulkheads of the machinery space, collision bulkhead and those transverse bulkheads located between them.
- (2) The calculated values of still water torsional moment for each loading condition are to be easily compared with the permissible values of the still water torsional moment stated in the loading manual.

3.3 Lashing Software

3.3.1 General

3.3.1.1 General

For container carriers engaged in international voyages, the lashing software in accordance with Annex 3.1, Part 2-1, Part C is to be provided on board the ship.

Annex 3.1 REQUIREMENTS FOR LASHING SOFTWARE

An1. General

An1.1 Application

An1.1.1

All seagoing dedicated container ships are to comply with these minimum requirements.

An1.2 Definition

An1.2.1

1 Lashing software is an electronic data processing tool for onboard analysis of forces in container stacks and thereby reflects the parameters of the lashing system as described in the Cargo Securing Manual prepared in accordance with the Administration requirements.

2 An approved lashing software is not a substitute for the approved Cargo Securing Manual. It is considered as a supplement to the approved Cargo Securing Manual.

3 The lashing software is a ship specific tool, and the results of the calculations are only applicable to the ship for which it has been approved.

An2. Operation Manual

An2.1 Operation Manual

An2.1.1

1 An operation manual is to be provided for the lashing software and be kept on board.

2 The language of the operation manual is to be the same as the language of the approved Cargo Securing Manual. A translation into another language considered appropriate may be required.

3 The operation manual should contain descriptions and instructions, as appropriate, of the following (1) to (9).

(1) A general description of the lashing software

(2) Installation

(3) Function keys

(4) Menu displays

(5) Input and output data

(6) Required minimum hardware to operate the software

(7) Instruction on testing the lashing software with the test loading condition

(8) A list of all terms, definitions, error messages and warnings likely to be encountered by the user

(9) In the case of error messages and warnings, there are to be unambiguous user instructions for subsequent action to be taken in each case

An3. Functional Requirements

An3.1 Functional Requirements

An3.1.1

1 The lashing software is to be capable of calculating forces on containers and container securing equipment for any loading conditions for each container stack.

2 It is also to be capable of indicating the respective permissible values in order to assist the master in his/her judgement on whether the ship is loaded within the approved limits. The following (1) to (7) parameters are to be presented.

(1) Summary of ship particulars such as IMO No., length, and breadth

(2) Summary of loading conditions showing relevant input parameters such as draught and GM

- (3) Stack and container positions
 - (4) Actual stack weights verified against permissible stack weights
 - (5) Relevant properties of securing devices, including permissible loads
 - (6) Accelerations and other external forces such as wind containers are exposed to
 - (7) Listing of all calculated forces on containers and container securing equipment, and evaluation of compliance of the calculated forces with the corresponding allowable values
- 3** The container and lashing arrangements in each bay on deck and in holds are to be shown graphically.
 - 4** The data are to be presented on screen and in hard copy printout in a clear and unambiguous manner.
 - 5** A clear warning is to be given on screen and in hard copy printout if any of the allowable forces are exceeded.
 - 6** In addition to the printout content, each page of the printout is to contain ship's identification, lashing software name and version number, date and time of the printout, and the title of the loading condition. The printout is to be paginated sequentially, and the total number of printout pages is to be shown.
 - 7** Units of measurement are to be clearly identified and used consistently.
 - 8** Incorrect data input by the users, such as negative draught values, is to be prohibited. An error message is to be prompted on screen and in hard copy printout in a clear and unambiguous manner.

An4. Test Loading Conditions

An4.1 Test Loading Conditions

An4.1.1

- 1** The lashing software is to be delivered with test loading conditions for selected stacks and bays covering applicable stowage patterns for containers of different dimensions contained in the Cargo Securing Manual, as per the Rules of the Society.
- 2** The test loading conditions and their results are to be permanently stored in the computer where the lashing software is installed and be protected against unintentional or unauthorised modifications and access.

An5. Approval of Lashing Software

An5.1 Approval of Lashing Software

An5.1.1

- 1** The lashing software is subject to approval by the Society and is to include the following **(1)** to **(5)**.
 - (1) Verification that the latest ship data has been used
 - (2) Verification and approval of the test loading conditions and their results
 - (3) Verification if requirements of **An3.** are satisfied
 - (4) Checking of proper installation, and verification of the instrument on board in accordance with the approved test loading conditions
 - (5) Checking the availability of the operation manual on board
- 2** In case of modifications implying changes in the ship's design or container securing arrangement, the software is to be modified accordingly and re-approved by the Society.
- 3** Any changes in software version related to the container securing calculations are to be reported to and be approved by the Society.
- 4** Upon installation, the lashing software is to be verified with the approved test loading conditions in the presence of the surveyor. It is to be checked that the operation manual for the lashing software is available on board.
- 5** Verification by the Society does not absolve the shipowner of responsibility for ensuring that the information supplied into the lashing software is consistent with the current condition of the ship and approved Cargo Securing Manual.

An6. Acceptable Tolerances

An6.1 Acceptable Tolerances

An6.1.1

1 The accuracy of the computational results from the lashing software for the particular ship, on which the lashing software will be installed, is to be determined by using reference computation results deemed appropriate by the Society.

2 The tolerance of the accuracy of the results from the lashing software is to be below 1.0 % of the allowable values. However, deviations may be accepted subject to review by the Society provided that there is a satisfactory explanation for the deviation and that there will be no adverse effects on the safety of the ship.

An7. Other Requirements

An7.1 Other Requirements

An7.1.1

The lashing software and its data are to be protected against unintentional or unauthorised modifications and access.

Chapter 4 LOADS

4.1 General

4.1.1 Overview

4.1.1.1 Structure and Overview of this Chapter

Each section of this Chapter defines the additional requirements shown in **Table 4.1.1-1** as the loads used for each formula and each strength assessment to determine the structural dimensions specified in each chapter of **Part 2-1** and **Part 1**.

Table 4.1.1-1 Overview of Chapter 4

Section	Title	Overview
4.1	General	Requirements for the general principles of Chapter 4
4.2	Loads to be Considered in Longitudinal Strength	Additional requirements for hull girder loads to be considered in the longitudinal strength requirements specified in Chapter 5 and Chapter 5, Part 1 .
4.3	Loads to be Considered in Local Strength	Additional requirements for various loads to be considered in the local strength requirements specified in Chapter 6, Part 1 .
4.4	Loads to be Considered in Strength of Primary Supporting Structures	Additional requirements for various loads to be considered in the primary supporting structural strength requirements specified in Chapter 7 and Chapter 7, Part 1 .
4.5	Loads to be Considered in Strength Assessment by Cargo Hold Analysis	Additional requirements for various loads to be considered in the requirements for strength assessment by cargo hold analysis specified in Chapter 8 and Chapter 8, Part 1 .
4.6	Loads to be Considered in Fatigue	Additional requirements for various loads to be considered in the fatigue strength assessment requirements specified in Chapter 9 and Chapter 9, Part 1 .

1. 4.2 Loads to be Considered in Longitudinal Strength

4.2.1 General

4.2.1.1 General

1 The loads to be considered in the longitudinal strength requirements specified in **Chapter 5** and **Chapter 5, Part 1** are also to be in accordance with the requirements of **4.2**.

2 Additional requirements for loads in the maximum load condition are to be in accordance with the requirements of **4.2.2**.

3 Additional requirements for loads in the harbour condition are to be in accordance with the requirements of **4.2.3**.

4.2.2 Maximum Load Condition**4.2.2.1 General**

1 Loads in maximum load condition are to be in accordance with this 4.2.2 instead of the requirements of 4.3.2, Part 1.

2 The requirements of 4.2.2 are to be applied to ships that fall under all of the following (1) to (4).

(1) $90 \leq L_C \leq 500$

(2) $5 \leq L_C/B \leq 9$

(3) $2 \leq B/T_{SC} \leq 6$

(4) $0.55 \leq C_B \leq 0.9$

3 The vertical still water bending moment and the vertical still water shear force are to be in accordance with the requirements of 4.2.2.2.

4 The vertical wave bending moment is to be in accordance with the requirements of 4.2.2.3, and the vertical wave shear force is to be in accordance with the requirements of 4.2.2.4.

5 The horizontal bending moments and torsional moment are to be in accordance with the requirements of 4.2.2.6.

6 For ships that do not fall under any of -2 above, or for ships deemed necessary by the Society, special consideration is to be given to the vertical wave bending moment, the vertical wave shear force, the horizontal wave bending moment, and the wave torsional moment by direct load analysis, etc.

4.2.2.2 Vertical Still Water Bending Moment and Vertical Still Water Shear Force

1 Vertical still water bending moments and vertical still water shear forces are to be calculated at each section along the ship length for, in principle, the design cargo and ballast conditions, based on amount of bunker, fresh water and stores at departure and arrival. In principle, the values are calculated at each transverse bulkhead of the cargo area, the centre of each cargo hold, the collision bulkhead, the front bulkhead of the engine room, and the intermediate position between the front bulkhead and the rear bulkhead of the engine room. The values at any other positions may be obtained by linear interpolation.

2 Where the amount and disposition of consumables at any intermediate stage of the voyage are considered more severe, calculations for such intermediate conditions are to be performed in addition to those for departure and arrival conditions.

3 Where any ballasting and/or de-ballasting is intended during voyage, calculations of the intermediate condition just before and just after ballasting and/or de-ballasting any ballast tank are to be performed. In this calculation, the requirements of Annex 4.3, Chapter 4, Part 1 “Guideline for the Assessment of Longitudinal Strength Relating to Ballasting/Deballasting” are to be used.

4 As the maximum and minimum values of the vertical still water bending moment and vertical still water shear force, the permissible maximum vertical still water bending moment M_{SV_max} (kN-m), the permissible minimum vertical still water bending moment M_{SV_min} (kN-m), the permissible maximum vertical still water shear force Q_{SV_max} (kN), and the permissible minimum vertical still water shear force Q_{SV_min} (kN) are to be considered. These values are to envelop the following (1) and (2).

(1) The maximum and minimum vertical still water bending moments and shear forces for the seagoing loading conditions defined in the loading manual

(2) The maximum and minimum vertical still water bending moments and the maximum and minimum vertical still water shear forces determined by the designer

4.2.2.3 Vertical Wave Bending Moment

1 The vertical wave bending moment in hogging condition M_{WV-h} (kN-m) and vertical wave bending moment M_{WV-s} (kN-m) in sagging condition are to be in accordance with Table 4.2.2-1.

Table 4.2.2-1 Vertical Wave Bending Moments M_{WV-h} and M_{WV-s}

The vertical wave bending moment in hogging condition M_{WV-h} (kN-m)	$M_{WV-h} = 1.5C_R C_{Vh} L_C^3 C C_W \left(\frac{B}{L_C}\right)^{0.8} C_{NL-h}$
The vertical wave bending moment in sagging condition M_{WV-s} (kN-m)	$M_{WV-s} = 1.5C_R C_{Vs} L_C^3 C C_W \left(\frac{B}{L_C}\right)^{0.8} C_{NL-s}$
<p>Notes:</p> <p>C_R: Coefficient considering the effect of ship operation, taken as 0.85</p> <p>C_{NL-h}: Non-linear correction factor for hogging condition, as given by the following formula. However, not to be greater than 1.1.</p> $C_{NL-h} = 0.3 \frac{C_B}{C_W} \sqrt{T_{SC}}$ <p>C_{NL-s}: Non-linear correction factor for sagging condition, as given by the following formula. However, not to be less than 1.0.</p> $C_{NL-s} = 4.5 \frac{1 + 0.2C_{Bow}}{C_W \sqrt{C_B} \cdot L_C^{0.3}}$ <p>C_{Bow}: Bow flare shape coefficient, as given by the following formula:</p> $C_{Bow} = \frac{A_{DK} - A_{WL}}{0.2L_C z_f}$ <p>A_{DK}: Projected area in horizontal plane of uppermost deck (m^2) including the forecastle deck, if any, extending from $0.8L_C$. Any other structures, e.g. plated bulwark, are to be excluded (See Fig. 4.2.2-1)</p> <p>A_{WL}: Waterplane area (m^2) at the scantling draught extending from $0.8L_C$ forward</p> <p>z_f: Vertical distance (m) from the waterline at the scantling draught to the uppermost deck (or forecastle deck), measured at FE. Any other structures, e.g. plated bulwark, are to be excluded. (See Fig. 4.2.2-1).</p> <p>C_{Vh}, C_{Vs}: Distribution coefficient, as specified in Table 4.2.2-2 (See Fig. 4.2.2-2).</p> <p>C: Wave parameter, as given by the following formulae:</p> $C = 1 - 1.50 \left(1 - \sqrt{\frac{L_C}{L_{ref}}}\right)^{2.2} \text{ for } L_C \leq L_{ref}$ $C = 1 - 0.45 \left(\sqrt{\frac{L_C}{L_{ref}}} - 1\right)^{1.7} \text{ for } L_C > L_{ref}$ <p>L_{ref}: Reference length (m), as given by the following formula:</p> $L_{ref} = 315C_W^{-1.3}$	

 Fig. 4.2.2-1 Projected Area A_{DK} and Vertical Distance z_f

Table 4.2.2-2 Distribution Coefficient of Vertical Wave Bending Moment

x/L_c	C_{Vh}	C_{Vs}
$x/L_c = 0.00$	0.00	0.00
$x/L_c = 0.10$	0.15	-2/7
$x/L_c = 0.35$	1.00	-1.00
$x/L_c = 0.55$	1.00	-1.00
$x/L_c = 0.60$	0.85	-1.00
$x/L_c = 0.80$	0.25	-0.50
$x/L_c = 1.00$	0.00	0.00

Note:
Where x/L_c is in the middle of the table, it is determined by linear interpolation.

Fig. 4.2.2-2 Distribution Shape of Vertical Wave Bending Moment

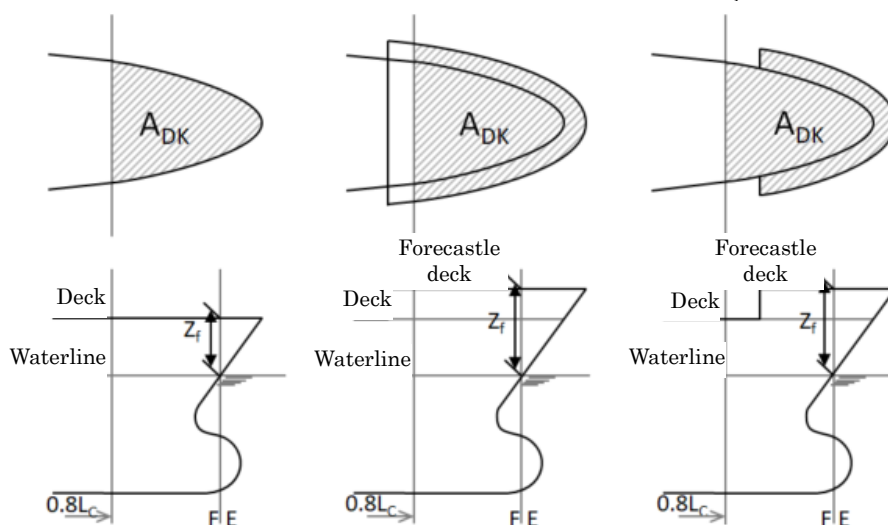
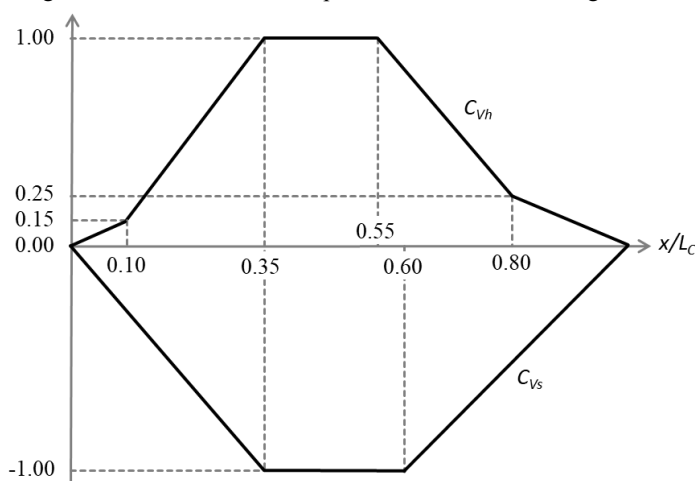

2 Notwithstanding the requirements in -1 above, where torsional strength assessments specified in 5.5 are carried out, the vertical wave bending moment in hogging condition M_{WV-h} ($kN\cdot m$) and vertical wave bending moment in sagging condition M_{WV-s} ($kN\cdot m$) are to be in accordance with **Table 4.2.2-3**.

 Table 4.2.2-3 Vertical Wave Bending Moments M_{WV-h} and M_{WV-s}
for Torsional Strength Assessments

The vertical wave bending moment in hogging condition M_{WV-h} ($kN\cdot m$)	$M_{WV-h} = 1.5C_R C_{Vh} L_c^3 C C_W \left(\frac{B}{L_c}\right)^{0.8} C_{NL-h}$
The vertical wave bending moment in sagging condition M_{WV-s} ($kN\cdot m$)	$M_{WV-s} = 1.5C_R C_{Vs} L_c^3 C C_W \left(\frac{B}{L_c}\right)^{0.8} C_{NL-s}$

Notes:
 C_R , C_{NL-h} , C_{NL-s} , C : As specified in **Table 4.2.2-1**.
 C_{Vh} , C_{Vs} : Distribution coefficient, as given by the following formulae, to be taken as 0 in the ranges of $x/L_c < 0$ and $x/L_c > 1$ (See **Fig. 4.2.2-3**):

$$C_{Vh} = 3.165 \cos\left(0.1\pi\left(\frac{x}{L_c} + 3.5\right)\right) \sin^2\left(\pi\frac{x}{L_c}\right)$$

$$C_{Vs} = -3.165 \cos\left(0.1\pi\left(\frac{x}{L_c} + 3.5\right)\right) \sin^2\left(\pi\frac{x}{L_c}\right)$$

Fig. 4.2.2-3 Distribution Shape of Vertical Wave Bending Moment for Torsional Strength Assessment

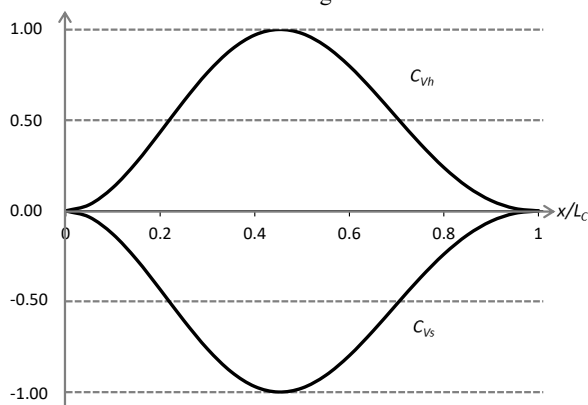

4.2.2.4 Vertical Wave Shear Force

The positive vertical wave shear force Q_{WV-p} (kN) and the negative vertical wave shear force Q_{WV-n} (kN) are to be in accordance with [Table 4.2.2-4](#).

 Table 4.2.2-4 Positive Vertical Wave Shear Force Q_{WV-p} and Negative Vertical Wave Shear Force Q_{WV-n}

Positive vertical wave shear force Q_{WV-p} (kN)	$x/L_c = 0$	0.0
	$0.15 \leq x/L_c \leq 0.3$	$Q_{WV-p-Aft} = +5.2C_R L_c^2 C C_W \left(\frac{B}{L_c}\right)^{0.8} (0.3 + 0.7C_{NL-h})$
	$0.4 \leq x/L_c \leq 0.55$	$Q_{WV-p-Mid} = +4.0C_R L_c^2 C C_W \left(\frac{B}{L_c}\right)^{0.8}$
	$0.65 \leq x/L_c \leq 0.85$	$Q_{WV-p-Fore} = +5.7C_R L_c^2 C C_W \left(\frac{B}{L_c}\right)^{0.8} (0.25 + 0.75C_{NL-s})$
	$x/L_c = 1.0$	0.0
Negative vertical wave shear force Q_{WV-n} (kN)	$x/L_c = 0$	$0.25Q_{WV-n-Aft}$
	$0.15 \leq x/L_c \leq 0.3$	$Q_{WV-n-Aft} = -5.2C_R L_c^2 C C_W \left(\frac{B}{L_c}\right)^{0.8} (0.3 + 0.7C_{NL-s})$
	$0.4 \leq x/L_c \leq 0.5$	$Q_{WV-n-Mid} = -4.0C_R L_c^2 C C_W \left(\frac{B}{L_c}\right)^{0.8}$
	$0.6 \leq x/L_c \leq 0.75$	$Q_{WV-n-Fore} = -5.7C_R L_c^2 C C_W \left(\frac{B}{L_c}\right)^{0.8} C_{NL-h}$
	$x/L_c = 1.0$	0.0
Notes:		
Where x/L_c is in the middle of the table, it is determined by linear interpolation. (See Fig. 4.2.2-4)		
C_R , C_{NL-h} , C_{NL-s} : As specified in Table 4.2.2-1 .		
C : As specified in Table 4.2.2-1 . However, L_{ref} is replaced with the following formula:		
$L_{ref} = 330C_W^{-1.3}$		

Fig. 4.2.2-4 Distribution Shape of Vertical Wave Shear Force

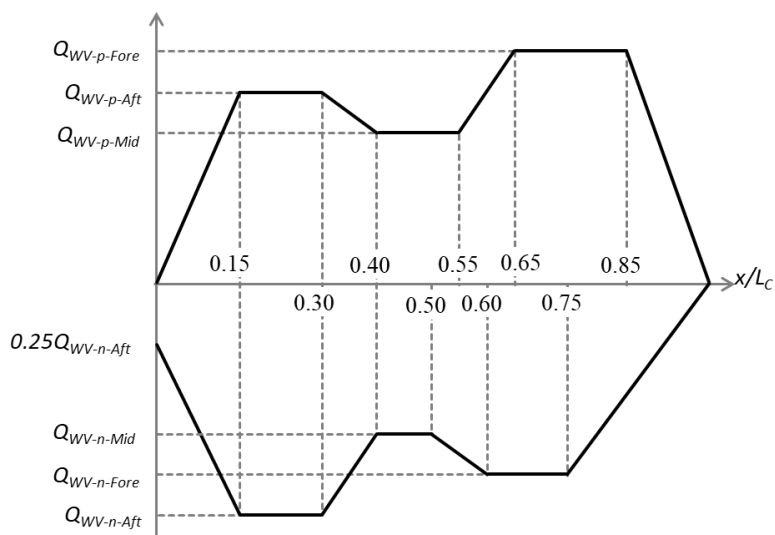

4.2.2.5 Load Combination

In the strength assessment, the case where the hogging moment is the maximum and the case where the sagging moment is the maximum are to be considered by combining the hull girder loads in still water and in waves. (See [Table 4.2.2-5](#) and [Fig. 4.2.2-5](#))

Table 4.2.2-5 Combination of Still Water and Wave Bending Moments and Shear Forces

Load case	Vertical bending moment		Vertical shear force	
	In still water	In waves	In still water	In waves
Hogging	M_{SV_max}	M_{WV-h}	Q_{SV_max} for $x \leq 0.5L_C$	Q_{WV-p} for $x \leq 0.5L_C$
			Q_{SV_min} for $x > 0.5L_C$	Q_{WV-n} for $x > 0.5L_C$
Sagging	M_{SV_min}	M_{WV-s}	Q_{SV_min} for $x \leq 0.5L_C$	Q_{WV-n} for $x \leq 0.5L_C$
			Q_{SV_max} for $x > 0.5L_C$	Q_{WV-p} for $x > 0.5L_C$

Notes:
 M_{SV_max} , M_{SV_min} , Q_{SV_max} , Q_{SV_min} : As specified in [4.2.2.2](#).
 M_{WV-h} , M_{WV-s} : As specified in [4.2.2.3](#).
 Q_{WV-p} , Q_{WV-n} : As specified in [4.2.2.4](#).

Fig. 4.2.2-5 Schematic Diagram of the Load Combination for Finding Cases where the Hogging Moment is the Maximum and Cases where the Sagging Moment is the Maximum Shown in Table 4.2.2-5

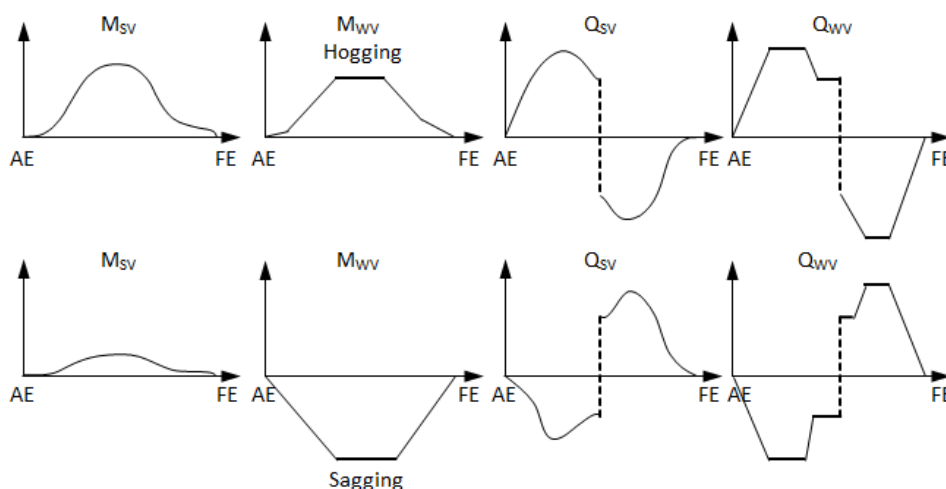

4.2.2.6 Horizontal Bending Moment and Torsional Moment

1 Where torsional strength assessment are carried out by whole ship analysis specified in 5.5.2, the horizontal bending moment and torsional moment of the following (1) to (3) are to be considered. (See Table 4.2.2-6)

- (1) Horizontal wave bending moments M_{WH1} (kN-m) and M_{WH2} (kN-m)
- (2) Still water torsional moments M_{ST1} (kN-m) and M_{ST2} (kN-m)
- (3) Wave torsional moments M_{WT1} (kN-m) and M_{WT2} (kN-m)

Table 4.2.2-6 Horizontal Bending Moment and Torsional Moment when Assessing Torsional Strength by Whole Ship Analysis

Horizontal wave bending moments	M_{WH1} (kN-m)	$M_{WH1} = 0.32C_R C_1 C_{H1} L_C^2 T_{SC} \sqrt{\frac{L_c - 35}{L_c}}$
	M_{WH2} (kN-m)	$M_{WH2} = 0.32C_R C_1 C_{H2} L_C^2 T_{SC} \sqrt{\frac{L_c - 35}{L_c}}$
Still water torsional moments	M_{ST1} (kN-m)	$M_{ST1} = M_{ST,max} \cdot C_{T1}$
	M_{ST2} (kN-m)	$M_{ST2} = M_{ST,max} \cdot C_{T2}$
Wave torsional moments	M_{WT1} (kN-m)	$M_{WT1} = C_R C_{T1} \cdot [1.3C_1 L_C T_{SC} C_B (0.65T_{SC} + e) + 0.2C_1 L_C B^2 C_W]$
	M_{WT2} (kN-m)	$M_{WT2} = C_R C_{T2} \cdot [1.3C_1 L_C T_{SC} C_B (0.65T_{SC} + e) + 0.2C_1 L_C B^2 C_W]$

Notes:

C_R : Coefficient considering the effect of ship operation, taken as 0.85

C_{H1} , C_{H2} : Distribution coefficient, as given by the following formulae, to be taken as 0 in the ranges of $x/L_C < 0$ and $x/L_C > 1$ (See Fig. 4.2.2-6):

$$C_{H1} = -\cos\left(0.77\pi\left(\frac{x}{L_C} - 0.52\right)\right) \cdot \sin^2\left(\pi\frac{x}{L_C}\right) \cdot \left[\frac{1 - \exp(-6x/L_C)}{1 - \exp(-3)}\right]$$

$$C_{H2} = -\sin\left(0.77\pi\left(\frac{x}{L_C} - 0.52\right)\right) \cdot \sin^2\left(\pi\frac{x}{L_C}\right) \cdot \left[\frac{1 - \exp(-6x/L_C)}{1 - \exp(-3)}\right]$$

$M_{ST,max}$: Largest value of the permissible maximum still water torsional moment in the longitudinal direction as described in the loading manual (kN-m).

C_{T1} , C_{T2} : Distribution coefficient, as given by the following formulae, to be taken as 0 in the ranges of $x/L_c < 0$ and $x/L_c > 1$ (See Fig. 4.2.2-7):

$$C_{T1} = -1.0 \left[\sin \left(2\pi \frac{x}{L_c} \right) + 0.1 \sin^2 \left(\pi \frac{x}{L_c} \right) \right] \cdot \exp \left(-0.35 \frac{x}{L_c} \right) \cdot \exp \left(-8 \left(2 \frac{x}{L_c} - 1 \right)^{10} \right)$$

$$C_{T2} = -0.5 \left[-\sin \left(3\pi \frac{x}{L_c} \right) + 0.65 \sin^3 \left(\pi \frac{x}{L_c} \right) \right] \cdot \exp \left(-0.4 \frac{x}{L_c} \right) \cdot \exp \left(-8 \left(2 \frac{x}{L_c} - 1 \right)^{10} \right)$$

e : Distance from baseline to shear centre at the midship cross section (m)⁽¹⁾

(1) The position of the shear centre can be calculated by finding the point of action of the shearing force where a torsional moment does not occur in the cross section when the shearing force in the horizontal direction acts on the traverse section of the hull. For example, the position can be calculated by applying Annex 5.2, Part 1 “Calculation of Shear Flow”.

Fig. 4.2.2-6 Distribution Shape of Horizontal Wave Bending Moments C_{H1} and C_{H2}

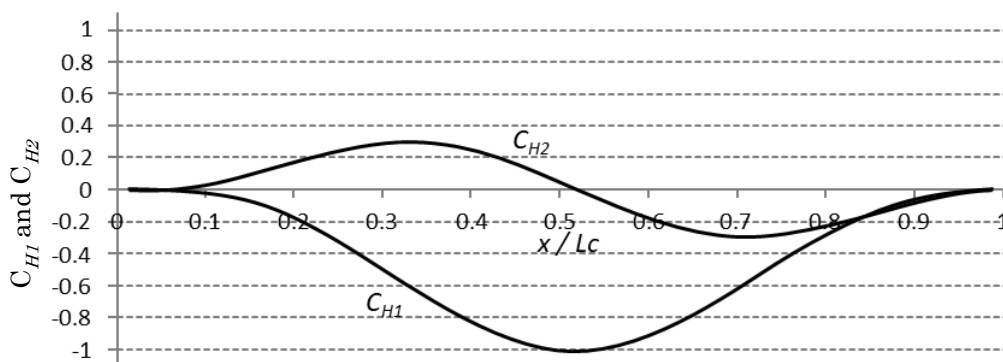
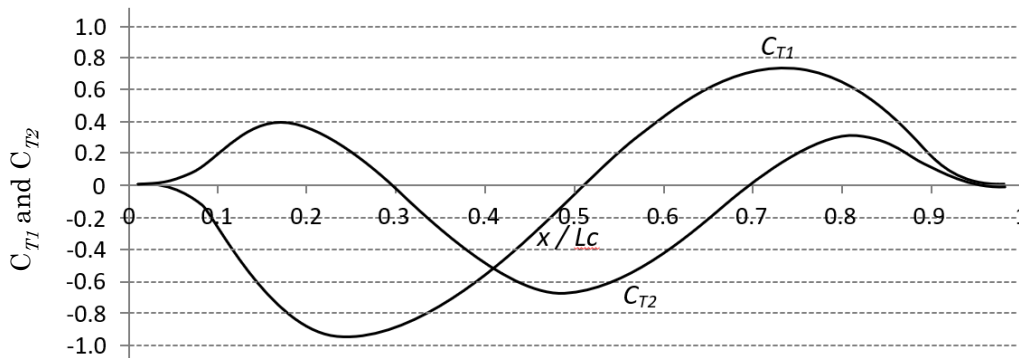

Fig. 4.2.2.7 Distribution Shape of Torsional Moments C_{T1} and C_{T2}



2 Where torsional strength assessment is carried out by the formula specified in 5.5.3, the horizontal bending moment and torsional moment of the following (1) to (3) are to be considered.

- (1) Horizontal wave bending moment M_{WH3} (kN-m) (See Table 4.2.2-7)
- (2) Still water torsional moment M_{ST3} (kN-m) (See Table 4.2.2-7)
- (3) Wave torsional moment M_{WT3} (kN-m) (See Table 4.2.2-7)

Table 4.2.2-7 Horizontal Bending Moment and Torsional Moment when Assessing Torsional Strength by Formula

Horizontal wave bending moment	M_{WH3} (kN-m)	$M_{WH3} = 0.32 C_R C_1 C_{H3} L_c^2 T_{SC} \sqrt{\frac{L_c - 35}{L_c}}$
Still water torsional moment	M_{ST3} (kN-m)	$M_{ST3} = 0.23 L_c N_R W_C$
Wave torsional moment	M_{WT3} (kN-m)	$M_{WT3} = 7.0 K_2 C_W^2 B^3 \left(1.75 + 1.5 \frac{e}{D_S} \right)$
Notes:		
C_R : Coefficient considering the effect of ship operation, taken as 0.85		

C_{H3} : As given by the following formulae. The mean value is calculated by linear interpolation.

For $x/L_C \leq 0$, $C_{H3} = 0.0$

For $0.35 \leq x/L_C \leq 0.65$, $C_{H3} = 1.0$

For $x/L_C \geq 1.0$, $C_{H3} = 0.0$

N_R : Maximum number of rows of containers to be loaded in the cargo hold

W_C : Average weight per 20 ft container to be loaded, taken as 100 kN

K_2 : As given the following formula:

$$K_2 = \sqrt{1 - \left(\frac{300 - L_C}{300}\right)^2}$$

e : Distance from baseline to shear centre at the midship section (m), according to the requirements of [Table 4.2.2-6](#) or the following formula:

$$e = e_1 - \frac{d_0}{2}$$

e_1, d_0 : As specified in [5.5.3.2\(4\)](#).

4.2.3 Harbour Condition

4.2.3.1 Vertical Bending Moment in Harbour

1 The vertical bending moment to be considered in the harbour condition is to be the maximum vertical bending moment in harbour M_{PT_max} (kN-m) and the minimum vertical bending moment in harbour M_{PT_min} (kN-m).

2 M_{PT_max} is to be greater than or equal to the value obtained by multiplying the permissible maximum vertical still water bending moment during voyage M_{SV_max} specified in [4.2.2.2](#) by 1.1. Moreover, M_{PT_min} is to be less than the value obtained by multiplying the permissible minimum vertical still water bending moment during voyage M_{SV_min} specified in [4.2.2.2](#) by 1.1. However, if M_{SV_min} is a positive value, M_{PT_min} is to be taken as 0.

3 Notwithstanding the requirements of -2 above, where the designer determines the maximum vertical bending moment and the minimum vertical bending moment in the loading conditions in harbour, in consideration of the cargo loading/unloading sequence, etc., the values are to be considered. The value M_{PT_max} that is less than the value specified in -2 above, and the value M_{PT_min} that is greater than the value specified in -2 above may be used. However, M_{PT_max} is not to be less than M_{SV_max} and M_{PT_min} is not to be greater than M_{SV_min} .

4.2.3.2 Vertical Shear Force in Harbour

1 The vertical shear force to be considered in the harbour condition is to be the maximum vertical shear force in harbour Q_{PT_max} (kN) and the minimum vertical shear force in harbour Q_{PT_min} (kN).

2 Q_{PT_max} is to be greater than or equal to the value obtained by multiplying the permissible maximum vertical still water shear force during voyage Q_{SV_max} specified in [4.2.2.2](#) by 1.1. Moreover, Q_{PT_min} is to be less than or equal to the value obtained by multiplying the permissible minimum vertical still water bending moment during voyage Q_{SV_min} specified in [4.2.2.2](#) by 1.1.

3 Notwithstanding the requirements of -2 above, where the designer determines the maximum vertical shear force and the minimum vertical shear force in the loading conditions in harbour, in consideration of the cargo loading/unloading sequence, etc., the values are to be considered. The value Q_{PT_max} that is less than the value specified in -2 above, and the value Q_{PT_min} that is greater than the value specified in -2 above may be used. However, Q_{PT_max} are not to be less than Q_{SV_max} and Q_{PT_min} are not to be greater than Q_{SV_min} .

4.3 Loads to be Considered in Local Strength

4.3.1 General

4.3.1.1 General

1 The loads to be considered in the local strength requirements specified in [Chapter 6, Part 1](#) are also to be in accordance with the requirements of [4.3](#).

2 Additional requirements for loads in the maximum load condition are to be in accordance with the requirements of [4.3.2](#).

3 Additional requirements for loads in the flooded conditions are to be in accordance with the requirements of [4.3.3](#).

4.3.2 Maximum Load Condition

4.3.2.1 Lateral Loads

1 Where the contact point between the container cargo and the hull structure is located directly above the connection between primary supporting members and plate members, the internal pressure of the cargo may not be considered.

2 In applying 4.4.2.4, Part 1, the parameters (GM , z_G etc.) required to calculate the dynamic pressure due to ballast water are to be the values in the ballast condition. The same parameters are to be applied where the dynamic pressure due to liquid other than ballast water, such as the pressure due to fuel oil tank, is considered. However, the values in Table 4.3.2-1 may be used if the parameters are not available.

Table 4.3.2-1 Simple Formulae for Parameters

Loading condition	Draught $T_{LC}(m)$ amidships	Z coordinate z_G (m) of the centre of gravity of the ship	Metacentric height $GM(m)$	Radius of gyration K_{xx} (m)
Ballast condition	T_{BAL}	$0.20 \frac{B}{C_{B_{LC}}}$	$\frac{T_{LC}}{2} + \frac{B^2}{T_{LC} C_{B_{LC}}} \frac{3C_{W_{LC}} - 1}{24} - z_G$	$0.40B$

4.3.2.2 Hull Girder Loads

1 In applying 4.4.2.9, Part 1, the vertical bending moment in still water and in waves are to be in accordance with the following (1) and (2).

- (1) $M_{SV_{max}}$ and $M_{SV_{min}}$ are to be the values of the permissible maximum vertical still water bending moments and the permissible minimum vertical still water bending moments in seagoing conditions specified in 4.2.2.2.
- (2) M_{WV-h} and M_{WV-s} are to be the values of the vertical wave induced bending moments in the hogging condition and sagging condition specified in 4.2.2.3.

2 For load condition RP , combination of $M_{SV_{max}}$ and $M_{SV_{min}}$ does not need to be considered.

4.3.3 Flooded Condition

4.3.3.1 Vertical Bending Moments in Flooded Conditions

In applying 4.4.4.2, Part 1, the vertical bending moments in flooding condition, $M_{FD_{max}}$ and $M_{FD_{min}}$, are to be in accordance with the following (1) and (2).

- (1) $M_{SV_{max}}$ and $M_{SV_{min}}$ are to be the values of the permissible maximum vertical still water bending moment and the permissible minimum vertical still water bending moment during voyage specified in 4.2.2.2.
- (2) $0.45M_{WV-h}$ and $0.45M_{WV-s}$ are to be the values obtained by multiplying the vertical wave bending moments in the hogging condition and sagging condition specified in 4.2.2.3 by 0.45.

4.4 Loads to be Considered in Strength of Primary Supporting Structures

4.4.1 General

4.4.1.1 General

1 The loads to be considered in the requirements for strength of primary supporting structures specified in Chapter 7 and Chapter 7, Part 1 are to be in accordance with the requirements of 4.4.

2 Additional requirements for loads in the maximum load condition are to be in accordance with the requirements of 4.4.2.

3 Additional requirements for loads in the harbour condition are to be in accordance with the requirements of 4.4.3.

4 Additional requirements for loads in the flooded condition are to be in accordance with the requirements of 4.4.4.

4.4.2 Maximum Load Condition

4.4.2.1 General

1 The requirements for simple girders are also to be in accordance with the relevant requirements of 4.3.

2 For the requirements of double hull, the loads specified in Table 4.4.2-1 are to be considered. However, if deemed necessary by the Society, additional loading patterns considering the loading condition described in the loading manual may be required.

Table 4.4.2-1 Loads to be Considered in Maximum Load Condition

Structures to be assessed		Loading patterns			Equivalent design wave	Difference between external and internal pressure to be considered (kN/m^2)
		Draught(m)	Vertical still water bending moment ($kN-m$)	Loaded to be considered		
Double bottom	S1	T_{SC}	$M_{SV\ max}$	Container cargo	HM-1 / HM-2	Double bottom: P_{DB} Double side: P_{DS}
Double side	S2	T_{SC}	$M_{SV\ min}$	Container cargo	BP-1P / BP-	
	S3	T_{SC}	$M_{SV\ min}$	Container cargo	1S	

4.4.2.2 External Pressure

For the requirements of double hull structures, the hydrostatic pressure at the draught and the hydrodynamic pressure at the equivalent design wave specified in [Table 4.4.2-2](#) are to be considered.

Table 4.4.2-2 External and Internal Pressure to be Considered

Structures to be assessed		$P_{DB}(kN/m^2)^{(1)(2)}$	$P_{DS}(kN/m^2)^{(1)(2)}$
Double bottom	S1 ⁽³⁾	$P_{exs} + P_{exw} - P_{in_{s1}}$	$P_{exs} + P_{exw}$
Double side	S2	$P_{exs} + P_{exw} - P_{in_{s1}}$	$P_{exs} + P_{exw}$
	S3	$P_{exs} + P_{exw} - P_{in_{s3}}$	$P_{exs} + P_{exw}$

Notes:

P_{exs} , P_{exw} : Hydrostatic and Hydrodynamic pressures (kN/m^2) acting on bottom shell in the case of P_{DB} , and the values acting on side shell in the case of P_{DS} . Each value is to be calculated in accordance with [4.6.2.4, Part 1](#).

$P_{in_{s1}}$, $P_{in_{s3}}$: In general, the values considering the effect of container cargo (kN/m^2) is to be taken as 0; however, when there are no partial bulkheads and there are two or more bays between watertight bulkheads in the cargo hold under assessment, or when there are partial bulkheads and there are two or more bays within the range from the watertight bulkhead to the partial bulkhead in the cargo hold under assessment, such values are to be given by the following formula.

$$P_{in_{s1}} = 0.15\rho g T_{SC}$$

$$P_{in_{s3}} = 0.3\rho g T_{SC}$$

(1) Load calculation points are to be in accordance with [7.3.1.5, Part 1](#) for all loading conditions.

(2) When calculating loads, $T_{LC} = T_{SC}$.

(3) P_{exw} is to be not less than the value of P_{exw} for HM-2 at x_G , which is the X coordinate (m) at the centre of gravity of the ship.

4.4.2.3 Internal Pressure

For the requirements of double hull, the internal pressure specified in [Table 4.4.2-2](#) is to be considered.

4.4.2.4 Vertical Bending Moment

1 For the requirements of double hull, the vertical still water bending moment and the vertical wave bending moment in the equivalent design wave specified in [Table 4.4.2-2](#) are to be considered.

2 The vertical wave bending moment considered for each equivalent design wave is to be in accordance with [4.6.2.10, Part 1](#). However, M_{WV-h} and M_{WV-s} are to be the values of the vertical wave bending moments in the hogging condition and sagging condition specified in [4.2.2.3](#).

4.4.3 Harbour Condition

4.4.3.1 General

For the requirements of double hull, the loads specified in [Table 4.4.3-1](#) are to be considered. However, where deemed necessary by the Society, additional loading patterns considering the loading condition described in the loading manual may be requested.

Table 4.4.3-1 Loads to be Considered in Harbour Condition

Structures to be assessed		Loading patterns			Difference between external and internal pressure to be considered (kN/m^2)
		Draught(m)	Vertical still water bending moment in harbour ($kN-m$)	Loaded to be considered	
Double bottom	$P1$	$0.6T_{SC}$	M_{PT_max}	None	Double bottom: P_{DB} Double side: P_{DS}
Double side	$P2$	$0.6T_{SC}$	M_{PT_max}	None	

4.4.3.2 External Pressure

For the requirements of double hull, the hydrostatic pressure specified in [Table 4.4.3-2](#) are to be considered.

Table 4.4.3-2 External and Internal Pressure to be Considered

Structures to be assessed		$P_{DB}(kN/m^2)^{(1)}$	$P_{DS}(kN/m^2)^{(1)}$
Double bottom	$P1$	P_{exs}	P_{exs}
Double side	$P2$	P_{exs}	P_{exs}

Notes: P_{exs} : Hydrostatic pressure (kN/m^2) act on bottom shell in case of P_{DB} . That value act on side shell in case of P_{DS} . Each value is calculated in accordance with [4.6.2.4, Part 1](#).

(1) Load calculation points is in accordance with [7.3.1.5, Part 1](#) for all loading conditions.

4.4.3.3 Vertical Bending Moment in Harbour

For the requirements of double hull, the vertical bending moment in harbour is to be in accordance with the requirements of [4.4.3.1](#).

4.4.4 Flooded Condition

4.4.4.1 Vertical Bending Moments in Flooded Conditions

In applying [4.5.5, Part 1](#), the vertical bending moment in flooded condition is to be in accordance with the following (1) and (2).

- (1) M_{SV_max} and M_{SV_min} are to be the values of the permissible maximum vertical still water bending moments and the permissible minimum vertical still water bending moments in seagoing conditions specified in [4.2.2.2](#).
- (2) $0.45M_{WV-h}$ and $0.45M_{WV-s}$ are to be the values obtained by multiplying the vertical wave bending moments in the hogging condition and sagging condition specified in [4.2.2.3](#) by 0.45.

4.5 Loads to be Considered in Strength Assessment by Cargo Hold Analysis

4.5.1 General

4.5.1.1 General

1 The loads to be considered in the strength assessment by the cargo hold analysis specified in [Chapter 8](#) and [Chapter 8, Part 1](#) are also to be in accordance with the requirements of [4.5](#).

- 2 Additional requirements for loads in the maximum load condition are to be in accordance with the requirements of [4.5.2](#).
- 3 Additional requirements for loads in the harbour condition are to be in accordance with the requirements of [4.5.3](#).
- 4 Additional requirements for loads in the flooded condition are to be in accordance with the requirements of [4.5.4](#).

4.5.2 Maximum Load Condition

4.5.2.1 Loading Conditions

1 The loading conditions specified in [Table 4.5.2-1](#) are to be considered instead of those specified in [4.5.2.1, Part 1](#). The loading conditions specified in the loading manual may be required where deemed necessary by the Society.

2 As for tow-island type container carriers, where deemed necessary to carry out structural strength assessment of fuel oil tanks located below the bridge, the loading conditions under consideration are to be determined based upon the tank arrangement, etc. and the loading conditions are to be submitted beforehand to the Society for Approval. An example is shown in [Table 4.5.2-2](#).

Table 4.5.2-1 Loading Conditions to be Considered in Maximum Load Condition





Loading condition	Loading pattern and container cargo in the target hold	Draught	Vertical still water bending moment	Equivalent design wave
40' containers loading condition (1)	 <p>Container: 40' containers (2) Ballast and fuel oil tanks: Empty</p>	T_{SC}	M_{SV_max}	HM-2 FM-2 BR-1P BR-1S BP-1P BP-1S
Light 40' containers loading condition (1)	 <p>Container: Light 40' containers (3)(4)(5) Ballast and fuel oil tanks: Empty</p>	T_{SC}	M_{SV_max}	HM-2 FM-2 BR-1P BR-1S BP-1P BP-1S
20' containers loading condition (1)	 <p>Container: 20' containers (2)(6) Ballast and fuel oil tanks: Empty</p>	$0.9T_{SC}$	M_{SV_min}	HM-1 FM-1 BR-1P BR-1S BP-1P BP-1S
One bay empty condition (1)	 <p>Container: 40' containers (2)(7) Ballast and fuel oil tanks: Empty</p>	T_{SC}	M_{SV_max}	HM-2 FM-2
				
<p>Notes:</p> <ol style="list-style-type: none"> (1) The radius of gyration (m) around the X-axis is taken as $0.38B$ in the 20-foot container cargo loading condition, and is taken as $0.35B$ in other loading conditions. In any condition, GM is the value in the full load condition. However, the value calculated based on the weight distribution according to the loading condition to be considered can be used. (2) Container unit weight is to be calculated as the permissible stacking weight divided by the maximum number of tiers planned. (3) Light container unit weight in hold is to be taken as 50 % of its related container unit weight. (4) Light container unit weight on deck is to be taken as 50 % of its related container unit weight or 17 t, whichever is the lesser. (5) It is assumed that cargo holds other than the target hold are loaded with 40-foot container cargo. The definition of target hold is in accordance with the requirements of Chapter 8, Part 1. (6) It is assumed that cargo holds other than the target hold are loaded with 40-foot lightweight container cargo. (7) For one bay empty condition, if the cargo hold consists of two or more bays, then each bay is to be considered entirely empty in hold and on deck (other bays full) in turn as separate load cases. 				

Table 4.5.2-2 Loading Conditions to be Considered in the Assessment of Fuel Oil Tanks
 under the Deckhouses in Two-island Design Ships

Loading condition	Loading pattern		Draught	Vertical still water bending moment	Equivalent design wave
Ballast condition ⁽¹⁾	S1T	 <p>Container: Empty Ballast tank: Full Fuel oil tank: Full</p>	T_{BAL}	M_{SV_min}	HM-1 FM-1 BR-1P BR-1S BP-1P BP-1S
	S2T	 <p>Container: Empty Ballast tank: Full Fuel oil tank: Full and Empty⁽³⁾</p>	T_{BAL}	M_{SV_min}	HM-1 FM-1 BR-1P BR-1S BP-1P BP-1S
Full load condition ⁽²⁾	S3T	 <p>Container: 40° containers Ballast tank: Empty Fuel oil tank: Empty</p>	T_{SC}	M_{SV_max}	HM-2 FM-2 BR-1P BR-1S BP-1P BP-1S
<p> : As specified in Table 4.5.2-1. : Fuel oil : Ballast water </p> <p>Notes:</p> <p>(1) The radius of gyration (m) around the X-axis is taken to be $0.40B$. However, the value calculated based on the weight distribution according to the loading condition to be considered can be used.</p> <p>(2) The radius of gyration (m) around the X-axis is taken to be $0.35B$. However, the value calculated based on the weight distribution according to the loading condition to be considered can be used.</p> <p>(3) Loading condition such that horizontal pressure acts on one side of each longitudinal bulkhead that divides the fuel oil tank is to be considered.</p>					

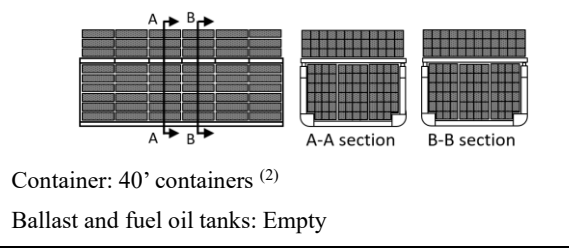
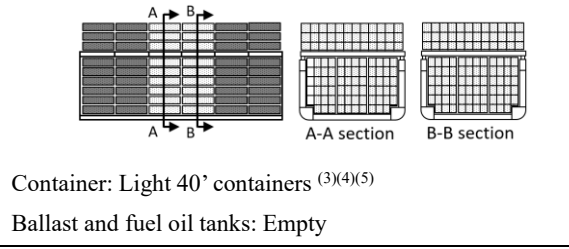
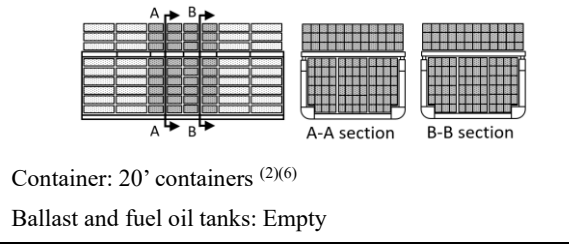
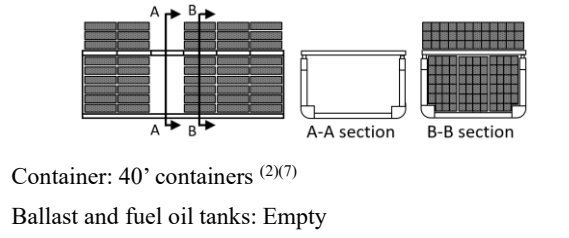
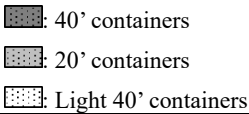
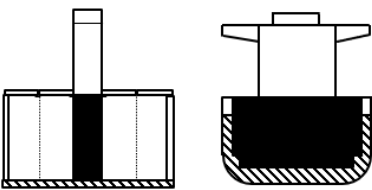
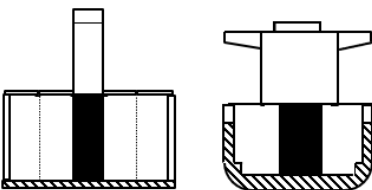
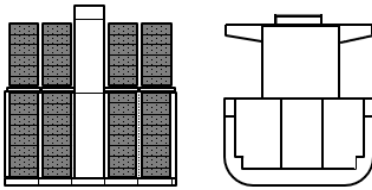
4.5.2.2 Container Load

In applying [4.6.2.7, Part 1](#), as for containers stowed on decks or hatchway covers, loads in the vertical direction are to be applied to the position of the top of the hatch coaming, and loads in the longitudinal direction are to be applied to the position of the locking devices of the hatch covers.

4.5.2.3 Hull Girder Loads



In applying [4.6.2.10, Part 1](#), the vertical still water bending moment for the loading condition to be considered is to be in accordance with the requirements of [4.5.2.1](#). M_{WV-h} and M_{WV-s} are to be the values of the vertical wave bending moment in the hogging and sagging conditions specified in [4.2.2.3](#).

4.5.3 Harbour Condition

4.5.3.1 Loading Conditions

In applying 4.6.3.1, Part 1, the loading conditions specified in Table 4.5.3-1 are to be considered.

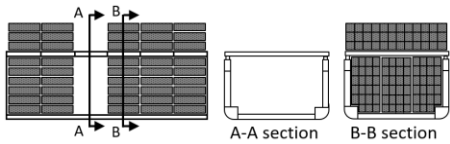
Table 4.5.3-1 Loading Conditions to be Considered in Harbour Condition

Loading condition	Loading pattern		Draught	Vertical bending moment in harbour
One bay empty condition ⁽¹⁾	<i>P1</i>	 <p>Container: 40' containers ⁽²⁾ Ballast tank: Empty Fuel oil tank: Empty</p>	<i>T_{SC}</i>	<i>M_{PT_max}</i>
 : As specified in Table 4.5.2-1.				
Notes:				
(1) For one bay empty condition, if the cargo hold consists of two or more bays, then each bay is to be considered entirely empty in hold and on deck (other bays full) in turn as separate load cases.				
(2) Container unit weight is to be calculated as the permissible stacking weight divided by the maximum number of tiers planned.				

4.5.3.2 Vertical Bending Moment in Harbour

1 The vertical bending moment in harbour is to be in accordance with the requirements of 4.2.3.1 instead of the requirements of 4.5.3.3, Part 1.

2 The vertical bending moment in harbour for the loading condition to be considered is to be in accordance with the requirements of 4.5.3.1.

4.5.4 Flooded Condition

4.5.4.1 Vertical Bending Moment in Flooded Conditions

In applying 4.6.5.5, Part 1, the vertical bending moment in the flooded conditions is to be in accordance with the following (1) and (2).

- (1) $M_{SV_{max}}$ and $M_{SV_{min}}$ are to be the values of the permissible maximum vertical still water bending moments during voyage specified in 4.2.2.2.
- (2) $0.45M_{WV-h}$ and $0.45M_{WV-s}$ are to be the values obtained by multiplying the vertical wave bending moments in the hogging condition and sagging condition specified in 4.2.2.3 by 0.45.

4.6 Loads to be Considered in Fatigue

4.6.1 General

4.6.1.1 General

1 The loads to be considered in the fatigue strength assessment specified in Chapter 9 and Chapter 9, Part 1 are also to be in accordance with the requirements of 4.6.

2 Additional requirements for loads in the cyclic load condition are to be in accordance with the requirements of 4.6.2.

4.6.2 Cyclic Load Condition

4.6.2.1 General

1 The loads to be considered in the assessment of torsional fatigue strength by whole ship analysis specified in 9.4 are to be in accordance with the requirements of 4.6.3 instead of the requirements of 4.7.2, Part 1. However, where deemed necessary by the Society, consideration of loads not in accordance with 4.6.3 may be required.

2 The loads to be considered in the simplified stress analysis and finite element analysis specified in 9.3, Part 1 and 9.4, Part 1

are to be in accordance with 4.6.4 in addition to the requirements of 4.7, Part 1.

4.6.3 Loads to be Considered in Torsional Fatigue Strength Assessment by Whole Ship Analysis

4.6.3.1 Loading Conditions

1 In assessing fatigue strength, loading conditions to be considered in which the most important stress state that acts on the hull for a long period of time are to be selected.

2 As a loading condition corresponding to the loading condition of -1 above for typical container carriers, only the condition where the container cargo is loaded almost homogeneously in each cargo hold is to be considered. In this case, the draught is the value obtained by multiplying the scantling draught by 0.82.

3 The values obtained from Table 4.6.3-1 may be used for the metacentric height GM (m), the height of the centre of gravity of the ship Z_G (m) and the radius of gyration K_{xx} (m) in the loading conditions specified in -2 above.

4.6.3.2 Hull Girder Loads

1 Vertical still water bending moment M_{SV} is to be calculated in accordance with the following formula.

$$M_{SV} = C_{F_{SV}} M_{SV_{max}}$$

$C_{F_{SV}}$: Coefficient considering the effects of the loading condition, to be taken as 0.8.

$M_{SV_{max}}$: Permissible maximum vertical still water bending moment ($kN-m$) specified in 4.2.2.2

2 The vertical wave bending moment M_{WV-h} ($kN-m$) in the hogging condition and the vertical wave bending moment M_{WV-s} ($kN-m$) in the sagging condition are to be in accordance with Table 4.6.3-2.

3 The horizontal wave bending moments M_{WH1} and M_{WH2} ($kN-m$) are to be in accordance with Table 4.6.3-3.

4 The wave torsional moments M_{WT1} and M_{WT2} ($kN-m$) are to be in accordance with Table 4.6.3-4.

Table 4.6.3-1 Simplified Formulae for Parameters

Loading condition	Draught amidships T_{LC} (m)	Z coordinate at the centre of gravity of the ship z_G (m)	Metacentric height GM (m)	Radius of gyration K_{xx} (m)
Container cargo homogeneously loaded condition	$0.82T_{SC}$	$0.25 \frac{B}{C_{B_{LC}}}$	$\frac{T_{LC}}{2} + \frac{B^2}{T_{LC} C_{B_{LC}}} \frac{3C_{W_{LC}} - 1}{24} - z_G$	$0.38B$

Table 4.6.3-2 Vertical Wave Bending Moments M_{WV-h} and M_{WV-s}

The vertical wave bending moment in hogging condition M_{WV-h} ($kN-m$)	$M_{WV-h} = 1.5 C_{F_{WV}} C_{Vh} L_C^3 C C_W \left(\frac{B}{L_C}\right)^{0.8}$
The vertical wave bending moment in sagging condition M_{WV-s} ($kN-m$)	$M_{WV-s} = 1.5 C_{F_{WV}} C_{Vs} L_C^3 C C_W \left(\frac{B}{L_C}\right)^{0.8}$
Notes:	
$C_{F_{WV}}$: Fatigue coefficient, as given by the following formula.	
$C_{F_{WV}} = C_{F1_{WV}} C_{F2_{WV}} C_{F3_{WV}}$	
$C_{F1_{WV}}$: Coefficient considering speed effects, to be taken as 1.2.	
$C_{F2_{WV}}$: Conversion coefficient for the exceedance probability level to be considered in fatigue strength assessment, to be taken as 0.22.	
$C_{F3_{WV}}$: Coefficient considering the effects of the loading condition, to be taken as 0.82.	
C_{Vh} , C_{Vs} : Distribution coefficient as given by the following formulae, to be taken as 0 in the ranges of $x/L_C < 0$ and $x/L_C > 1$ (See Fig. 4.6.3-1):	
$C_{Vh} = 1.044 \sin\left(\pi \frac{x}{L_C}\right) \sin^2\left(0.45\pi \frac{x}{L_C} + 0.35\pi\right) \sin^2\left(0.6\pi \frac{x}{L_C} + 0.21\pi\right)$	
$C_{Vs} = -1.044 \sin\left(\pi \frac{x}{L_C}\right) \sin^2\left(0.45\pi \frac{x}{L_C} + 0.35\pi\right) \sin^2\left(0.6\pi \frac{x}{L_C} + 0.21\pi\right)$	
C : Wave parameter, as specified in Table 4.2.2-1.	

Table 4.6.3-3 Horizontal Wave Bending Moments M_{WH1} and M_{WH2}

Horizontal wave bending moment M_{WH1} (kN-m)	$M_{WH1} = 0.32C_{F_{WH}}C_1C_{H1}L_C^2T_{SC}\sqrt{\frac{L_C - 35}{L_C}}$
Horizontal wave bending moment M_{WH2} (kN-m)	$M_{WH2} = 0.32C_{F_{WH}}C_1C_{H2}L_C^2T_{SC}\sqrt{\frac{L_C - 35}{L_C}}$
Notes: $C_{F_{WH}}$: Fatigue coefficient, as given by the following formula. $C_{F_{WH}} = C_{F1_{WH}}C_{F2_{WH}}C_{F3_{WH}}$ $C_{F1_{WH}}$: Coefficient that considering speed effects, to be taken as 0.94. $C_{F2_{WH}}$: Conversion coefficient for the exceedance probability level to be considered in fatigue strength assessment, to be taken as 0.24. $C_{F3_{WH}}$: Coefficient considering the effects of the loading condition, to be taken as 0.82. C_{H1} , C_{H2} : Distribution coefficient, as specified in Table 4.2.2-6 .	

 Table 4.6.3-4 Wave Torsional Moments M_{WT1} and M_{WT2}

Wave torsional moment M_{WT1} (kN-m)	$M_{WT1} = C_{F_{WT}}C_{T1} \cdot [1.3C_1L_C T_{SC}C_B(0.65T_{SC} + e) + 0.2C_1L_C B^2 C_W]$
Wave torsional moment M_{WT2} (kN-m)	$M_{WT2} = C_{F_{WT}}C_{T2} \cdot [1.3C_1L_C T_{SC}C_B(0.65T_{SC} + e) + 0.2C_1L_C B^2 C_W]$
Notes: $C_{F_{WT}}$: Fatigue coefficient, as given by the following formula: $C_{F_{WT}} = C_{F1_{WT}}C_{F2_{WT}}C_{F3_{WT}}$ $C_{F1_{WT}}$: Coefficient considering speed effects, to be taken as 1.03. $C_{F2_{WT}}$: Conversion coefficient for the exceedance probability level to be considered, to be taken as 0.23 $C_{F3_{WT}}$: Coefficient considering the effects of the loading condition, to be taken as 0.82. C_{T1} , C_{T2} : Distribution coefficients, as given by the following formulae, to be taken as 0 in the ranges of $x/L_C < 0$ and $x/L_C > 1$: $C_{T1} = -1.1 \left[\sin\left(2\pi\frac{x}{L_C}\right) + 0.1\sin^2\left(\pi\frac{x}{L_C}\right) \right] \exp\left(-0.7\frac{x}{L_C}\right) \exp\left(-8\left(2\frac{x}{L_C} - 1\right)^{10}\right)$ $C_{T2} = -0.5 \left[-\sin\left(3\pi\frac{x}{L_C}\right) + 0.8\sin^3\left(\pi\frac{x}{L_C}\right) \right] \exp\left(-0.6\frac{x}{L_C}\right) \exp\left(-8\left(2\frac{x}{L_C} - 1\right)^{10}\right)$ e : Distance from baseline to shear centre at the midship section (m), as specified in Table 4.2.2-6	

Fig. 4.6.3-1 Distribution Shape of Vertical Wave Bending Moment

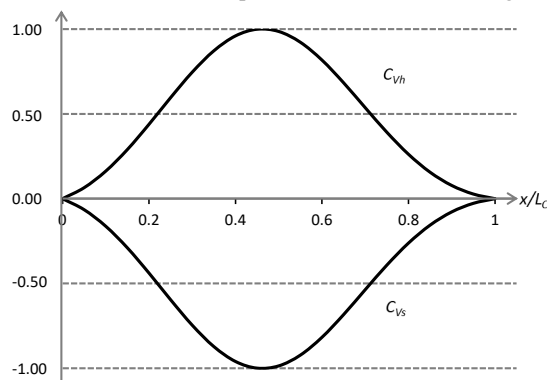
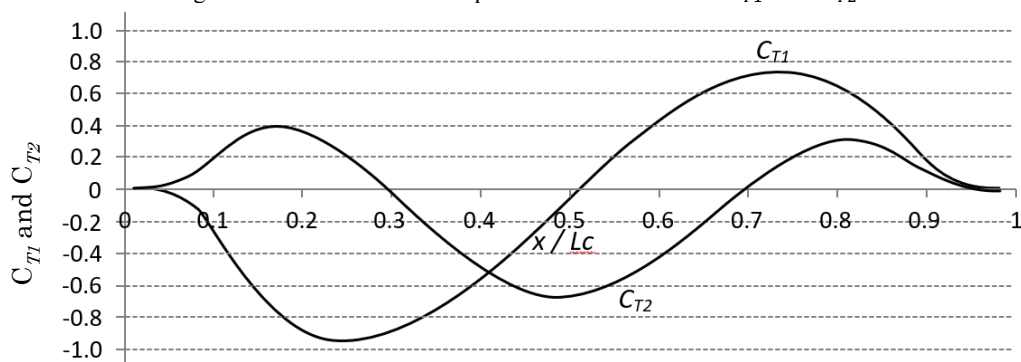

Fig. 4.6.3-2 Distribution Shape of Torsional Moments C_{T1} and C_{T2}

4.6.4 Loads to be Considered in Fatigue Strength Assessment by Simplified Stress Analysis and Finite Element Analysis Using Partial Structural Model

4.6.4.1 Loading Conditions

1 In assessing fatigue strength, loading conditions to be considered the most important stress state that acts on the hull for a long period of time are to be selected.

2 As a loading condition corresponding to the loading condition of -1 above for typical container carriers, only the condition where the container cargo is loaded almost homogeneously in each cargo hold is to be considered. In this case, the draught is the value obtained by multiplying the scantling draught by 0.82.

3 The values obtained from [Table 4.6.3-1](#) may be used for the metacentric height GM (m), the height of the centre of gravity of the ship Z_G (m) and the radius of gyration K_{xx} (m) in the loading conditions specified in -2 above.

4.6.4.2 Hull Girder Loads

1 Vertical still water bending moment M_{SV} is to be in accordance with the requirements of [4.6.3.2-1](#) instead of the requirements of [4.7.2.10, Part 1](#).

2 The vertical wave bending moment in hogging condition M_{WV-h} ($kN-m$) and vertical wave bending moment M_{WV-s} ($kN-m$) in sagging condition are to be determined in accordance with the requirements of [4.6.3.2-2](#) instead of the requirements of [4.7.2.10, Part 1](#).

3 When calculating the horizontal bending moment M_{WH} , it is necessary to apply [4.7.2.10, Part 1](#) and use the value obtained by multiplying the structural draught T_{LC} (m) by 0.82.

Chapter 5 LONGITUDINAL STRENGTH

5.1 General

5.1.1 Application

5.1.1.1

Container carriers to which **Part 2-1** applies are to comply with the requirements specified in this Chapter.

5.1.2 Continuity of Structure

5.1.2.1

- 1 Continuity of structure is to be maintained throughout the length of the ship.
- 2 Where significant changes in structural arrangement occur, adequate transitional structure is to be provided.

5.1.3 Evaluation Area

5.1.3.1

1 The stiffness, yield strength, buckling strength, and hull girder ultimate strength assessment specified in **5.1** are to be applied to the full length of the ship from AE to FE.

2 Notwithstanding the requirement in -1 above, evaluation areas near AE and FE and with an extremely small depth of the evaluation cross section need not be assessed.

3 The following locations (1) to (5) are to be assessed with adequate care:

- (1) In way of the for/aft ends of engine room
- (2) The fore and aft ends of the forward bridge block in case of two-island designs
- (3) At any locations where there are significant changes in hull cross section
- (4) In way of forward end of the foremost cargo hold
- (5) In way of aft end of the aft most cargo hold

5.1.4 Hull Girder Stress

5.1.4.1 Vertical Bending Moment

1 Vertical bending moment σ_{HG} (N/mm^2) is to be obtained from the following formula:

$$\sigma_{HG} = \frac{\gamma_S M_S + \gamma_W M_W}{I_y} (z - z_n) \times 10^5$$

γ_S, γ_W : Partial safety factors, to be taken as 1.0

M_S, M_W : Vertical still water bending moment and vertical wave bending moment ($kN-m$) under consideration, as specified in **Table 5.1.4-1**

I_y : Moment of inertia (cm^4) for the cross section under consideration

z : Vertical coordinate of the location under consideration (m)

z_n : Distance from the baseline to the horizontal neutral axis (m)

2 Vertical shear stress τ_{HG} (N/mm^2) is to be obtained from the following formula:

$$\tau_{HG} = \frac{(\gamma_S Q_S + \gamma_W Q_W) q_v}{t} \times 10^3$$

γ_S, γ_W : As specified in -1 above.

Q_S, Q_W : Vertical still water shear force and vertical wave shear force ($kN-m$) under consideration, as specified in **Table 5.1.4-2**

q_v : Shear flow (N/mm) at any location when shear force acts along the cross section under consideration, to be determined according to the calculation method which are specified in **Annex 5.2, Part 1 "CALCULATION OF SHEAR FLOW"**.

t : Thickness of plate considered (mm)

Table 5.1.4-1 Still Water and Wave Vertical Bending Moments to be Considered

Condition	M_S	M_W
Maximum load condition	Still water and wave vertical bending moment for the hogging and sagging load cases shown in 4.2.2.5	
Harbour condition	$M_{PT\ max}$ or $M_{PT\ min}$	0

Table 5.1.4-2 Still Water and Wave Vertical Shear Forces to be Considered

Condition	Q_S	Q_W
Maximum load condition	Still water and wave vertical shear force for the hogging and sagging load cases shown in 4.2.2.5	
Harbour condition	$Q_{PT\ max}$ or $Q_{PT\ min}$	0

5.2 Yield Strength Assessment

5.2.1 Bending Strength and Shear Strength

5.2.1.1 Evaluation Area

1 For each of the load cases “hogging” and “sagging”, the equivalent hull girder stress σ_{eq} (N/mm^2) is to be in accordance with the following formula:

$$\sigma_{eq} < \sigma_{perm}$$

$$\sigma_{eq} = \sqrt{\sigma_x^2 + 3\tau^2}$$

Where σ_x and τ are combination of hull girder stresses, to be taken as the following formulae according to the bending strength assessment and shear strength assessment, and where σ_{HG} and τ_{HG} are to be in accordance with 5.1.4.1.

$\sigma_x = \sigma_{HG}$, $\tau = 0$, for bending strength assessment

$\sigma_x = 0$, $\tau = \tau_{HG}$, for shear strength assessment

σ_{perm} : Permissible stress (N/mm^2), to be taken as

$$\sigma_{perm} = \frac{\sigma_Y}{\gamma_1 \gamma_2}$$

σ_Y : Specified minimum yield stress of the material (N/mm^2)

γ_1 : Partial safety factor for material, to be taken as

$$\gamma_1 = K \frac{\sigma_Y}{235}$$

γ_2 : Partial safety factor for load combinations and permissible stress, to be taken as follows:

$\gamma_2 = 1.24$, for bending strength assessment in the maximum load condition

$\gamma_2 = 1.46$, for bending strength assessment in the harbour condition

$\gamma_2 = 1.13$, for shear strength assessment in the maximum load condition

$\gamma_2 = 1.22$, for shear strength assessment in the harbour condition

2 The assessment locations of the bending stress and shear stress are to be in accordance with the following (1) and (2):

(1) The assessment locations of the bending stress are the following locations of cross section shown in (a) to (d):

- (a) at bottom
- (b) at deck
- (c) at top of hatch coaming
- (d) at any point where there is a change of steel yield strength

(2) The assessment locations of the shear stress are all structural elements that contribute to the shear strength capability.

5.2.1.2 Minimum Section Modulus

1 The gross section modulus of the transverse section of the hull amidship is not to be less than the value of Z_{gr_min} (cm^3)

obtained from the following formula:

$$Z_{gr_min} = KC_1 L_C^2 B (C_{B1} + 0.7) \text{ (cm}^3\text{)}$$

2 The scantlings of longitudinal members in way of the midship part are not to be less than the scantlings of longitudinal members at the midship which are determined by the requirement in -1 above, excluding changes in the scantlings due to variations in the sectional form of the transverse section of the hull.

5.2.1.3 Minimum Moment of Inertia of Hull Transverse Section

The moment of inertia of the transverse section of the hull I (cm^4) is not to be less than the value obtained from the following formula.

$$I_{min} = 1.55 L_C |M_S + M_W| \times 10$$

M_S , M_W : Vertical still water bending moment and vertical wave bending moment (kN-m) for the load cases “hogging” and “sagging” as specified in [4.2.2.5](#)

5.2.1.4 Calculation of Section Modulus and Moment of Inertia of Hull Transverse Section

The calculation of the section modulus and the moment of inertia of the hull transverse section is to be in accordance with the requirements specified in [5.2.1.4, Part 1](#).

5.3 Buckling Strength Assessment

5.3.1 General

5.3.1.1 Buckling Strength Assessment Judgment

For the plate panels and longitudinal stiffeners subject to vertical bending and vertical shear stresses, the following formula is to be applied.

$$\eta_{act} \leq 1$$

η_{act} : Buckling utilisation factor, to be obtained according to the requirements of [Annex 5.3](#).

5.3.1.2 Hull Girder Stress Used in Buckling Strength Assessment

During the buckling strength assessment, the following stress combinations described in (1) and (2) are to be considered for each of load cases “hogging” and “sagging” as specified in [4.2.2.5](#). Where σ_{HG} and τ_{HG} are to be in accordance with [5.1.4.1](#).

- (1) σ_{HG} , $0.7\tau_{HG}$
- (2) $0.7\sigma_{HG}$, τ_{HG}

5.4 Hull Girder Ultimate Strength

5.4.1 General

5.4.1.1 Application

The requirements in 5.4 apply to ships with a length L_C of 150 m or more.

5.4.1.2 Assessment Range

The hull girder ultimate strength is to be assessed in the cargo region and engine region.

5.4.2 Hull Girder Ultimate Strength Assessment

The following formula is to be satisfied.

$$\gamma_S M_S + \gamma_W M_W \leq \frac{M_U}{\gamma_M \gamma_{DB}}$$

γ_S : Partial safety factor for the vertical still water bending moment, to be taken as follows.

$$\gamma_S = 1.0$$

γ_W : Partial safety factor for the vertical wave bending moment, to be taken as follows.

$$\gamma_W = 1.2$$

M_S , M_W : Vertical still water bending moment and vertical wave bending moment (kN-m) for the load cases “hogging” and “sagging” as specified in [4.2.2.5](#)

M_U : The hull girder ultimate strength (kN-m), which is to be obtained by the method specified in [Annex 5.4, Part 1](#). However, instead of the load-end shortening curves formula $\sigma_{CR5} - \epsilon$ specified in [An2.3.8, Annex 5.4, Part 1](#), the following is to be used.

$$\sigma_{CR5} = \min \left\{ \Phi \sigma_{YP} \left[\frac{s}{l} \left(\frac{2.25}{\beta_E} - \frac{1.25}{\beta_E^2} \right) + 0.1 \left(1 - \frac{s}{l} \right) \left(1 + \frac{1}{\beta_E^2} \right)^2 \right] \right.$$

σ_{YP} : Standard minimum yield stress of plate material (N/mm^2)

Φ , β_E , s , l : As prescribed in [An2.3.8, Annex 5.4, Part 1](#).

γ_M : Partial safety factor for the hull girder ultimate strength, to be taken as follows.

$$\gamma_M = 1.05$$

γ_{DB} : Partial safety factor for the hull girder ultimate strength, considering the effect of double bottom bending given by the following formula. However, for cross sections where the double bottom breadth of the inner bottom is less than that at amidships or where the double bottom structure differs from at amidships (e.g. engine rooms), the factor γ_{DB} for hogging condition may be reduced subject to approval by the Society.

For hogging condition, $\gamma_{DB} = 1.15$

For sagging condition, $\gamma_{DB} = 1.0$

5.4.3 Hull Girder Ultimate Strength Assessment Considering Effect of Whipping Response and Lateral Load

For ships not less than 300 m in length L_C or which exceed 32.26 m in breadth B , in addition to the requirements specified in [5.4.2](#), the hull girder ultimate strength is to satisfy the following formula for the hogging condition. Notwithstanding the requirements under this paragraph, the effect of whipping and the hull girder ultimate strength considering the effect of lateral loads can be calculated more directly where deemed appropriate by the Society. This requirement applies to the transverse section located in the vicinity of the centre of the cargo hold at midship.

$$\gamma_S M_{SV-max} + \gamma_{Wh} M_{WV-h-Mid} \leq M_{U,DB}$$

γ_S : Partial safety factor for the vertical still water bending moment, to be taken as follows.

$$\gamma_S = 1.0$$

γ_{Wh} : Partial safety factor for the vertical wave bending moment, considering the effect of whipping, to be taken as follows:

$$\gamma_{Wh} = 1.5$$

M_{SV-max} : Permissible maximum vertical still water bending moment ($kN-m$) at the cross section under consideration while at sea prescribed in [4.2.2.2](#).

$M_{WV-h-Mid}$: Vertical wave bending moment ($kN-m$) in the amidship calculated according to the provision of [4.2.2.3](#).

$M_{U,DB}$: Hull girder ultimate strength ($kN-m$), considering the effect of lateral loads, to be obtained according to the requirements of [Annex 5.4](#).

5.5 Torsional Strength

5.5.1 General

5.5.1.1 Application

1 For ships meeting the criteria in the following (1) to (3), the torsional strength is to be assessed by the finite element analysis specified in [5.5.2](#).

- (1) Ships not less than 200 m in length L_C
- (2) Ships exceeding 32.26 m in breadth B
- (3) In cases where deemed necessary by the Society

2 For ships that do not meet all of the criteria specified in -1(1) to (3) and the widths of the hatchway amidship exceed $0.7B$, the torsional strength is to be assessed based on the formulae specified in [5.5.3](#).

3 Notwithstanding the requirements in -1 and -2 above, the torsional strength assessments may be carried out based on direct load analyses or direct strength calculations when deemed appropriate by the Society.

5.5.2 Torsional Strength Assessments Based on Finite Element Analysis

5.5.2.1 General

1 The procedure for the torsional strength assessments based on a finite element analysis is given in the following (1) to (3). (See [Fig. 5.5.2-1](#))

- (1) Vertical still water bending moments, vertical wave bending moments, horizontal wave bending moments, still water torsional

moments and wave torsional moments are to be considered as applied loads.

- (2) Stresses due to vertical still water bending moments, vertical wave bending moments, and horizontal wave bending moments are to be calculated according to a beam theory or a finite element analysis using a whole ship structural model.
- (3) Warping stresses due to vertical still water torsional moments and vertical wave torsional moments are to be calculated according to a finite element analysis using a whole ship structural model.
- (4) Yielding strength assessments and buckling strength assessments are to be carried out based upon evaluated stresses determined by combining the stress components.

2 Analysis programs are to have the following functions:

- (1) The influences of bending, shearing, axial, and torsional deflections can be effectively taken into account.
- (2) The behaviours of plan or space structures can be effectively expressed and or displayed under reasonable boundary conditions.

3 Analysis programs are to have sufficient accuracy. If deemed necessary, the Society may require the submission of details regarding the analysis method, verification of accuracy, etc.

Fig. 5.5.2-1 Evaluation Procedure

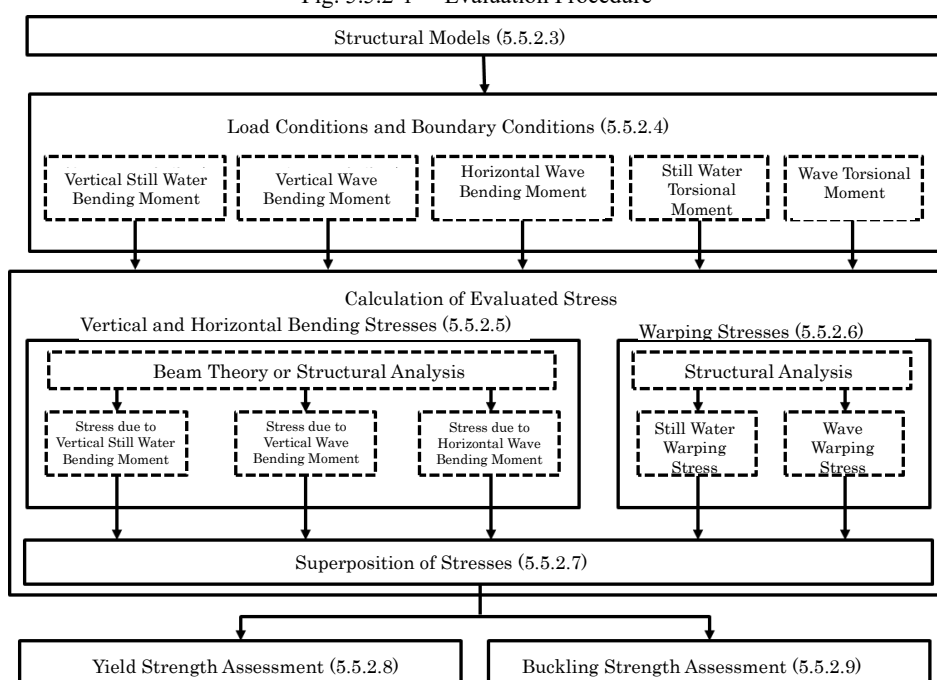

Note: Numbers in parentheses indicate sub-section number

5.5.2.2 Assessment Target Members

The following members (1) to (7) are to be assessed along the length of ship.

- (1) Hatch side coamings (including top plates)
- (2) Strength decks
- (3) Sheer strakes
- (4) Topmost strakes of inner hulls/bulkheads
- (5) Bottom shell plating, bilge plating
- (6) Longitudinal stiffeners attached to (1) to (5) above
- (7) Other members deemed necessary by the Society

5.5.2.3 Structural Models

1 The scope and members for modelling are to be in accordance with the following (1) and (2):

- (1) The entire ship, both port and starboard sides
- (2) All longitudinal members, primary supporting members and longitudinal stiffeners

2 The plate thickness and scantling of the stiffeners of the structural model are to be made in accordance with 3.3.3, Part 1.

3 Notwithstanding the requirement in -2 above, where deemed appropriate by the Society, assessment using the gross scantling

approach may be applied.

4 The types and properties of the elements used for modelling are to be in accordance with the following (1) and (2). Note that the definitions of element types are specified in **Table 5.5.2-1**.

- (1) For plate members, shell elements are to be used.
- (2) When modelling a general rolled steel for hull, Young’s modulus is to be 206,000 (N/mm^2) and Poisson’s ratio is to be 0.3.

5 The meshing of elements is to be in accordance with the following (1) and (2) (See **Fig. 5.5.2-2**):

- (1) Be performed so as to reproduce the structural responses of the whole ship accurately. In principle, meshing is to be in accordance with the following (a) to (c):
 - (a) The size of mesh is not to be greater than floor space in general.
 - (b) The aspect ratio of shell elements is to be kept as close to 1 as possible.
 - (c) Variation of the mesh size and the use of triangular elements are to be kept to a minimum.
- (2) Separate finite element models that use a finer mesh than usual may be used by applying the boundary conditions obtained from the structural model.

6 When modelling the stiffener, several stiffeners may be modelled complied together depending on the mesh size. However, the section modulus of hull in this case is to be equivalent to the actual section modulus of hull.

7 The validity of the structural model is conducted by checking that the stresses obtained when vertical bending moments and horizontal bending moments are each applied to the structural model is to be equivalent to the values calculated using beam theory.

Table 5.5.2-1 Types of Elements

Element type	Definition
Rod element	Line element with axial stiffness only and a constant cross-sectional area along the length of the element
Beam element	Line element with axial, torsional, and bi-directional shear and bending stiffness and with constant properties along the length of the element
Shell element	Quadratic element with in-plane stiffness and out-of-plane bending stiffness and with constant thickness

Fig. 5.5.2-2 Structural Models

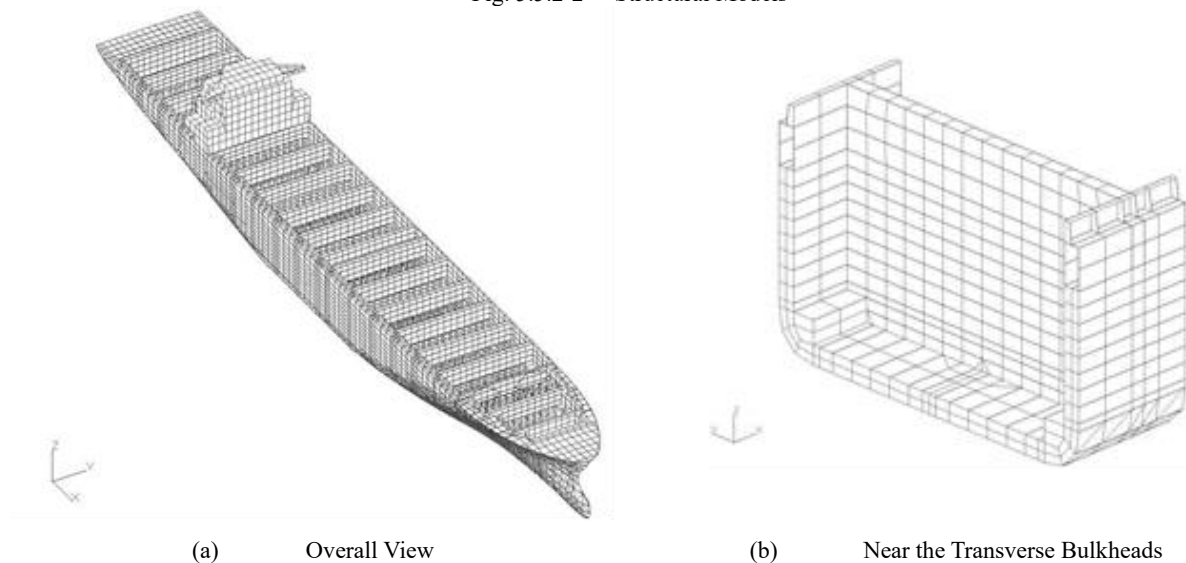

5.5.2.4 Load Conditions and Boundary Conditions

1 As load conditions, vertical still water bending moments, vertical wave bending moments, horizontal wave bending moments, and still water torsional moments caused by unbalanced loading of containers and wave torsional moments carrier are to be considered.

- 2 When applying the load, it is not to affect the axial stress caused by hull girder loads at the point of reference.
- 3 Torsional moments are, as a standard, to be applied in accordance with the following (1) to (3):
 - (1) Torsional moments acting on hull girders are to be applied to structural models as a series of bulkhead torsional moments resulting in a stepped curve. An approximated torsional step moment curve is shown in Fig. 5.5.2-3.

- (2) Torsional moments applied to bulkheads are the net change in torsional moment over the effective range of the bulkhead. The effective range of a bulkhead is the distance between the midpoints of the two adjacent bulkheads. The torsional moments at bulkhead i are specified as the following formulae (See Fig. 5.5.2-4):

$$\delta M_{WT1i} = M_{WT1} \Big|_{\frac{1}{2}(x_i+x_{i+1})} - M_{WT1} \Big|_{\frac{1}{2}(x_{i-1}+x_i)}$$

$$\delta M_{WT2i} = M_{WT2} \Big|_{\frac{1}{2}(x_i+x_{i+1})} - M_{WT2} \Big|_{\frac{1}{2}(x_{i-1}+x_i)}$$

x_i : x -coordinate of bulkhead i

- (3) The torsional moment at each bulkhead is to be reproduced by two equivalent shear forces on each side. An example of a method for applying shear force is shown in Fig. 5.5.2-5.

4 When analysing the vertical and horizontal bending moments applied, a method applying unit moments is to be used as the standard. Stresses corresponding to the moments prescribed in 4.4.2 are to be calculated based on the stresses obtained through structural analysis with unit moments applied.

5 Boundary conditions is to constrain the displacement of the structure at positions where the reaction force is considered to be small. Standard boundary conditions are to be given in Table 5.5.2-2.

Fig. 5.5.2-3 Torsional Moments Acting on Hull Girders (Approximated Torsional Step Moment)

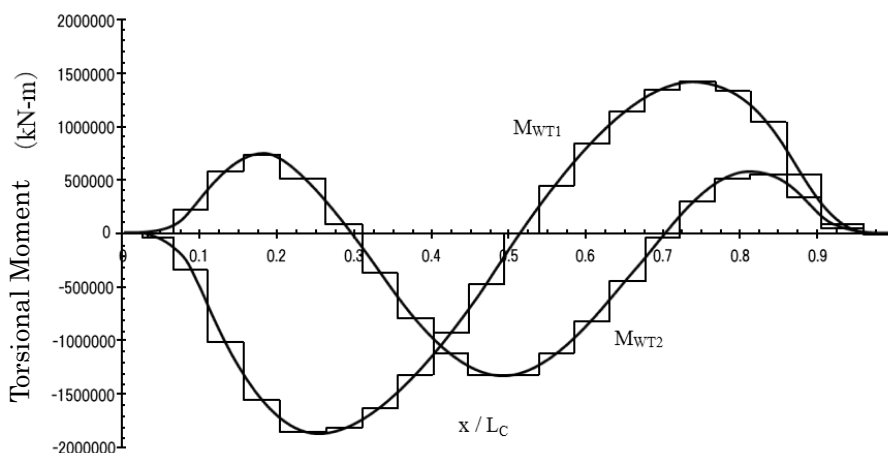

Fig. 5.5.2-4 Torsional Moment Applied to Bulkhead i

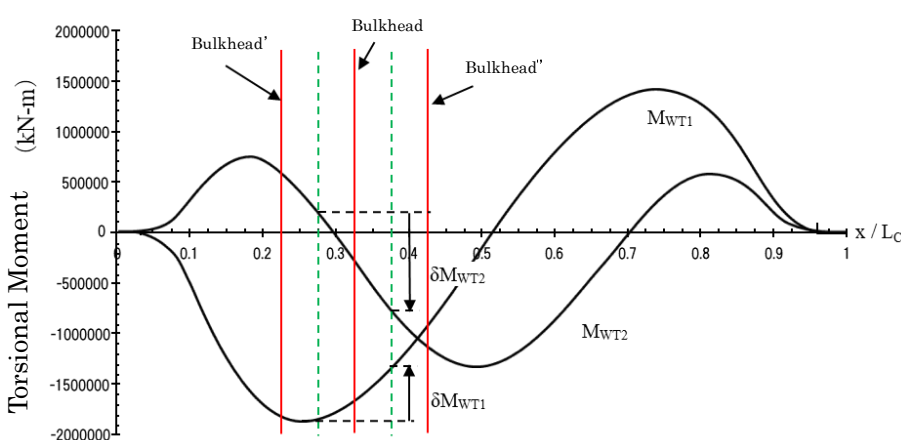

Fig. 5.5.2-5 Torsional Moment Reproduction Due to Shear Force

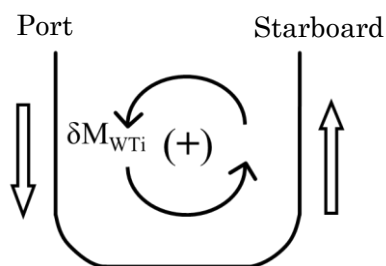

Table 5.5.2-2 Boundary Conditions at Model Ends

	Location	Translation			Rotation		
		X direction	Y direction	Z direction	Around the x-axis	Around the y-axis	Around the z-axis
Boundary conditions of torsional moment (See Fig. 5.5.2-6 (a))	Aft end of L_c	Fix	Fix	Fix	-	-	-
	Fore end of L_c	-	Fix	Fix	-	-	-
Boundary conditions of vertical bending moment (See Fig. 5.5.2-7)	Aft end of L_c	Fix	Fix	Fix	-	-	-
	Fore end of L_c	-	Fix	Fix	-	-	-
Boundary conditions of horizontal bending moment (See Fig. 5.5.2-8)	Aft end of L_c	Fix	Fix	Fix	-	-	-
	Fore end of L_c	Fix	-	Fix	-	-	-
	Transverse bulkheads of L_c	-	-	Fix	-	-	-

Notes:
 [-] means no constraint applied (free).
 The position of a constraint is to be the position in which the reaction force is thought to be small.
 This table may not be applied for some load applying methods and stress calculation methods

Fig. 5.5.2-6 Boundary Conditions of Torsional Moment

(a) Example 1

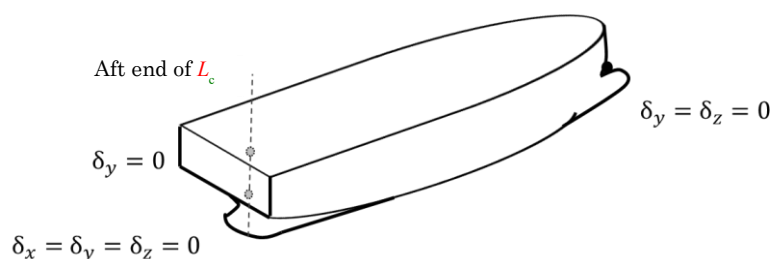

(b) Example 2

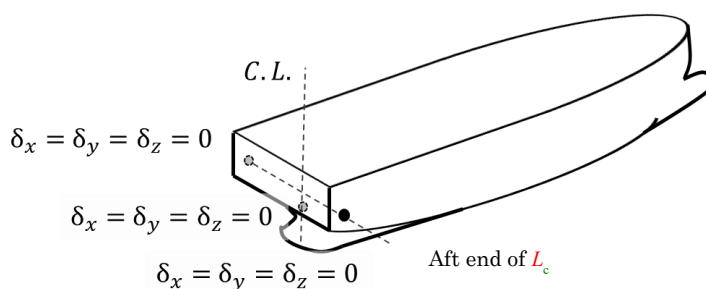

Fig. 5.5.2-7 Boundary Conditions and Loads Application of Vertical Bending Moment

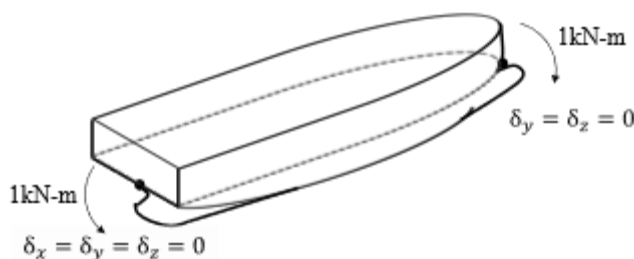
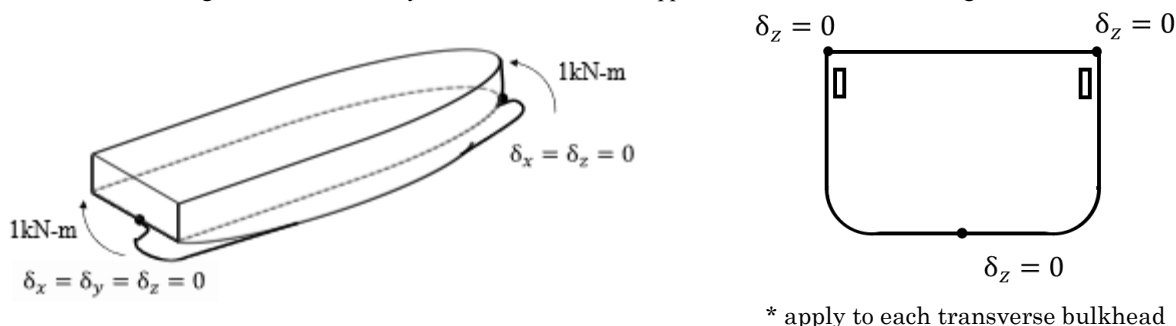

Fig. 5.5.2-8 Boundary Conditions and Loads Application of Horizontal Bending Moment



5.5.2.5 Calculation of Stresses due to Vertical Bending Moment and Horizontal Bending Moment

1 Stresses due to vertical bending moments and horizontal moments are to be in accordance with the following (1) to (3). The sign convention for tension stress is to be positive, while the sign convention for compressive stress is to be negative. When assessing based on the gross scantling in accordance with 5.5.2.7-2, I_{V-n50} , z_{n-n50} and I_{H-n50} specified in the following (1) to (3) are replaced to I_{V-gr} , z_{n-gr} and I_{H-gr} , respectively.

- (1) The stress due to vertical still water bending moment σ_{SV} (N/mm^2) is to be obtained from the following formula:

$$\sigma_{SV} = \frac{M_{SV}}{I_{V-n50}} \cdot (z - z_{n-n50}) \times 10^{-3} \quad (N/mm^2)$$

M_{SV} : Permissible maximum vertical still water bending moment $M_{SV,max}$ and permissible minimum vertical still water bending moment $M_{SV,min}$ ($kN-m$) specified in 4.2.2.2 at the cross section under consideration

I_{V-n50} : Moment of inertia around horizontal neutral axis (m^4) of the cross section

z : Z coordinate at the location under consideration (Vertical distance from base line) (m)

z_{n-n50} : The distance from base line to horizontal neutral axis (m) of the cross section

- (2) The stress due to horizontal wave bending moment σ_{WV} (N/mm^2) is to be obtained from the following formula:

$$\sigma_{WV} = \frac{M_{WV}}{I_{V-n50}} \cdot (z - z_{n-n50}) \times 10^{-3} \quad (N/mm^2)$$

M_{WV} : Vertical wave bending moments under the hogging condition M_{WV-h} and vertical wave bending moment under the sagging condition M_{WV-s} ($kN-m$) specified in 4.2.2.3 at the cross section under consideration. The combination of M_{SV} and M_{WV} specified in (1) above are based on load combination of hogging and sagging

conditions specified in **Table 4.2.2-5**.

I_{V-n50} : Moment of inertia around horizontal neutral axis (m^4) for the cross section

z : Z coordinate at the location under consideration (Vertical distance from base line) (m)

z_{n-n50} : The distance from base line to horizontal neutral axis (m) for the cross section

- (3) The stresses due to horizontal wave bending moments σ_{WH1} and σ_{WH2} (N/mm^2) are to be obtained from the following formulae:

$$\sigma_{WH1} = -\frac{M_{WH1}}{I_{H-n50}} \cdot y \times 10^{-3} (N/mm^2)$$

$$\sigma_{WH2} = -\frac{M_{WH2}}{I_{H-n50}} \cdot y \times 10^{-3} (N/mm^2)$$

M_{WH1} : First component of horizontal bending moment ($kN-m$) at the cross section under consideration specified in **4.2.2.6-1**

M_{WH2} : Second component of horizontal bending moment ($kN-m$) at the cross section under consideration specified in **4.2.2.6-1**

I_{H-n50} : Moment of inertia around centre line (m^4) for the cross section under consideration

y : Y coordinate at the location under consideration (Horizontal distance from centre line) (m)

- 2 Notwithstanding the requirements in -1 above, the stresses due to vertical bending moment and horizontal bending moment may be calculated using structural analysis of a whole ship finite element model. In this case, the effect of bending stresses locally generated in hatch corners need not be considered.

5.5.2.6 Calculation of Stress due to Torsional Moment

Stress due to torsional moment is to be in accordance with the following (1) and (2). The sign convention for tension stress is to be positive, while the sign convention for compressive stress is to be negative.

- (1) The still water torsional moments M_{ST1} and M_{ST2} specified in **4.2.2.6-1** are applied to the structural model, and a finite element analysis is conducted to calculate the stresses σ_{ST1} and σ_{ST2} (N/mm^2) caused by the still water torsional moments.
- (2) The wave torsional moments M_{WT1} and M_{WT2} specified in **4.2.2.6-1** are applied to the structural model, and a finite element analysis is conducted to calculate the stresses σ_{WT1} and σ_{WT2} (N/mm^2) caused by the wave torsional moments.

5.5.2.7 Evaluated Stress

- 1 Evaluated stress σ_T is to be determined in accordance with the following formula:

$$\sigma_T = \left\{ \sqrt{\sigma_{WV}^2 + (\sigma_{WH1} + \sigma_{WT1})^2} + \sqrt{\sigma_{WH2} + \sigma_{WT2})^2} + C_3 |\sigma_{SV}| + \sqrt{\sigma_{ST1}^2 + \sigma_{ST2}^2} \right\}$$

C_3 : The superposition of stresses coefficient, to be taken as follows:

In the case of $M_{SV} = M_{SV_min}$ and $M_{SV} > 0$ in **5.5.2.5-1 (1)**, to be taken as $C_3 = -1$

In other cases, to be taken as $C_3 = 1$

σ_{SV} : Stress due to vertical still water bending moment (N/mm^2), as given in **5.5.2.5**

σ_{WV} : Stress due to vertical wave bending moment (N/mm^2), as given in **5.5.2.5**

σ_{WH1} , σ_{WH2} : Stress due to horizontal wave bending moment (N/mm^2), as given in **5.5.2.5**.

σ_{ST1} , σ_{ST2} : Warping stress due to still water torsional moment (N/mm^2), as given in **5.5.2.6 (1)**.

σ_{WT1} , σ_{WT2} : Warping stress due to wave torsional moment (N/mm^2), as given in **5.5.2.6 (2)**.

- 2 When applying the requirement in -1 above and when each component of stress is obtained using the structural model of the gross scantling, the stress components are to be multiplied by 1.05 to correct the stress that corresponds to the net scantling.

5.5.2.8 Yield Strength Assessment

1 In the cargo hold to be analysed, the evaluation stress σ_T of each element that consists of all the members subject to assessment is to satisfy the following formulae. Mean stress corresponding to standard mesh size may be used when using smaller mesh size than the standard mesh size specified in **5.5.2.3-5**.

- (a) For hatch side coamings (including top plates), strength decks, sheer strakes, and topmost strakes of inner hulls/longitudinal bulkheads

$$\sigma_T \leq 200/K (N/mm^2)$$

- (b) For bottom shell plating and bilge plating

$$\sigma_T \leq 210/K (N/mm^2)$$

- 2 The requirements in -1 above need not be applied to the locations where localised stress increase is due to hatch deformation,

etc. (e.g. foremost cargo holds and the fore/aft ends of engine rooms and accommodation areas) provided that fatigue strength assessments are carried out. However, the reference stress obtained in accordance with 5.5.2.7 is to be less than the specified minimum yield stress of relevant steel assigned at such locations.

5.5.2.9 Buckling Strength Assessment

1 The requirements in 8.6.2.1, Part 1 are applied correspondingly for buckling assessments. However, the buckling permissible utilisation factor is to be taken as 0.9 for bottom shell plating, bilge plating and longitudinal stiffeners attached to these members.

2 Notwithstanding the requirement in -1 above, bilge plating longitudinally stiffened and longitudinal stiffeners attached to the bilge plating may be verified in accordance with the following (1) or (2) according to net thickness of bilge plating and bilge radius:

(1) In case where the bilge plating net thickness is not less than 14.5 mm and the bilge radius is not greater than 8 m, the following (a) and (b) are to be applied.

(a) The evaluation stress determined in accordance with 5.5.2.7 is not greater than 0.9 times the specified minimum yield stress of the steel used or 320 N/mm², whichever is smaller.

(b) The following formula is satisfied:

$$\sqrt{11 \cdot \left(\frac{t}{1000R}\right)^2 + \left(\frac{\pi t}{1000S}\right)^4 + \left(\frac{\pi t}{1000S}\right)^2} \geq 0.014$$

t : Bilge plating net plate thickness (mm)

S : Spacing (m) of stiffeners. To be taken as the girth length.

R : Bilge radius (m)

(2) If the bilge plating net thickness is less than 14.5 mm and the bilge radius is greater than 8 m, the evaluated stress determined in accordance with 5.5.2.7 is not to be greater than 0.9 times the buckling strength obtained by using non-linear analysis, and other methods.

5.5.3 Torsional Strength Assessment Based on Formulae

5.5.3.1 General

The evaluation procedure for torsional strength is given in the following (1) and (2):

(1) As load conditions, vertical still water bending moments, vertical wave bending moments, horizontal wave bending moments, still water torsional moment and wave torsional moments are to be considered.

(2) The strength assessment is to be carried out based upon the evaluation stress determined by combining each stress from the loads considered in (1) above.

5.5.3.2 Calculation of Stresses due to Vertical Bending Moment, Horizontal Bending Moment, and Torsional Moment

Stresses due to vertical bending moment, horizontal moment, and torsional moment are to be in accordance with the following (1) to (5). The sign convention for tension stress is to be positive, while the sign convention for compressive stress is to be negative.

(1) The stress due to vertical still water bending moment σ_{SV} (N/mm²) are to be obtained from the following formula:

$$\sigma_{SV} = \frac{|M_{SV}|}{Z_{V-n50}} \times 10^3$$

M_{SV} : Vertical still water bending moment (kN-m) for the load cases “hogging” and “sagging” as specified in 4.2.2.5

Z_{V-n50} : Section modulus (cm³) of the hull girder vertical bending at the strength deck at the cross-section position under consideration

(2) The stress due to vertical wave bending moment σ_{WV} (N/mm²) is to be obtained from the following formula:

$$\sigma_{WV} = \frac{M_{WV}}{Z_{V-n50}} \times 10^3$$

M_{WV} : Vertical wave bending moment (kN-m) for the load cases “hogging” and “sagging” specified in 4.2.2.5

Z_{V-n50} : Section modulus (cm³) of the hull girder vertical bending at the strength deck at the cross-section position under consideration

(3) The stress due to horizontal wave bending moment σ_{WH} (N/mm²) is to be obtained from the following formula:

$$\sigma_{WH} = \frac{M_{WH3}}{Z_{H-n50}} \times 10^3$$

M_{WH3} : Horizontal wave bending moment (kN-m) specified in 4.2.2.6-2.

Z_{H-n50} : Section modulus (cm³) of the hull girder horizontal bending at the hatch side at the cross-section position under consideration

- (4) The stress due to still water torsional moment σ_{ST} (N/mm^2) is to be obtained from the following formula:

For ships having ordinary structure, the stress is calculated using the scantlings at the midship section. Values for ships other than those above are to be at the discretion of the Society.

$$\sigma_{ST} = 0.000318 \frac{\omega \ell_C M_{ST3}}{I_\omega + 0.04 \ell_C^2 J}$$

M_{ST3} : Still water torsional moment ($kN-m$) specified in 4.2.2.6-2.

$$\omega = \frac{B_1}{2} (D_1 - e_1) + \frac{d_1}{2} (D_1 + e_1)$$

$$D_1 = D_S - \frac{d_0}{2}$$

$$B_1 = B - d_1$$

$$e_1 = \frac{(3D_1 - d_1)d_1 t_{d-n50} + (D_1 - d_1)^2 t_{s-n50}}{3d_1 t_{d-n50} + 2(D_1 - d_1)t_{s-n50} + B_1 t_{b-n50}/3}$$

d_0 : Height (m) of double bottom, as shown in Fig. 5.5.3-1.

d_1 : Breadth (m) of double hull side, as shown in Fig. 5.5.3-1.

t_{d-n50} , t_{s-n50} and t_{b-n50} : Mean thickness (m) of the deck, ship sides, and bottom are as given in Fig. 5.5.3-1.

When calculating mean thickness, the longitudinal members included in this range may be included.

ℓ_C : Distance (m) from the collision bulkhead to watertight bulkhead of the fore end of the machinery room

$$I_\omega = B_1^2 \{d_1 t_{d-n50} I_d + (D_1 - d_1) t_{s-n50} I_s + B_1 t_{b-n50} I_b\}$$

$$I_d = (D_1 - e_1) \left\{ \frac{3}{2} (D_1 - e_1) - d_1 \right\} + \frac{d_1^2}{3}$$

$$I_s = (D_1 - d_1) \left\{ \frac{1}{3} (D_1 - d_1) - e_1 \right\} + e_1^2$$

$$I_b = \frac{e_1^2}{6}$$

J : As given by the following formula:

$$J = \frac{2\{Bd_0 + 2(D_S - d_0)d_1\}^2}{\frac{3d_1}{t'_{d-n50}} + \frac{2(D_1 - d_1)}{t'_{s-n50}} + \frac{B_1}{t'_{b-n50}}}$$

t'_{d-n50} , t'_{s-n50} , t'_{b-n50} : Mean thickness (m) of deck, ship sides and bottom. When calculating mean thickness, only the strong deck, side shell plating, bottom shell plating, inner bottom plating, and longitudinal bulkheads is to be used, and other longitudinal members are not to be included.

- (5) The stress due to wave torsional moment, σ_{WT} (N/mm^2) is to be obtained from the following formulae:

For ships having ordinary structure, the stress is calculated using the scantlings at the midship section. Values for ships other than those above are to be at the discretion of the Society.

$$\sigma_{WT} = 0.000318 \frac{\omega \ell_C M_{WT3}}{I_\omega + 0.04 \ell_C^2 J}$$

M_{WT3} : Wave torsional moment specified in 4.2.2.6-2.

$$\omega = \frac{B_1}{2} (D_1 - e_1) + \frac{d_1}{2} (D_1 + e_1)$$

$$D_1 = D_S - \frac{d_0}{2}$$

$$B_1 = B - d_1$$

$$e_1 = \frac{(3D_1 - d_1)d_1 t_d + (D_1 - d_1)^2 t_{s-n50}}{3d_1 t_{d-n50} + 2(D_1 - d_1)t_{s-n50} + B_1 t_{b-n50}/3}$$

d_0 : Height (m) of double bottom, as shown in Fig. 5.5.3-1.

d_1 : Breadth (m) of double hull sides, as shown in Fig. 5.5.3-1.

t_{d-n50} , t_{s-n50} and t_{b-n50} : Mean thickness (m) of the deck, ship sides, and bottom are as given in Fig. 5.5.3-1.

When calculating mean thickness, the longitudinal members included in this range may be included.

ℓ_C : Distance (m) from the collision bulkhead to watertight bulkhead of the fore end of the machinery room

$$I_\omega = B_1^2 \{d_1 t_{d-n50} I_d + (D_1 - d_1) t_{s-n50} I_s + B_1 t_{b-n50} I_b\}$$

$$I_d = (D_1 - e_1) \left\{ \frac{3}{2} (D_1 - e_1) - d_1 \right\} + \frac{d_1^2}{3}$$

$$I_s = (D_1 - d_1) \left\{ \frac{1}{3} (D_1 - d_1) - e_1 \right\} + e_1^2$$

$$I_b = \frac{e_1^2}{6}$$

J: As given by the following formula:

$$J = \frac{2\{Bd_0 + 2(D_S - d_0)d_1\}^2}{\frac{3d_1}{t'_{d-n50}} + \frac{2(D_1 - d_1)}{t'_{s-n50}} + \frac{B_1}{t'_{b-n50}}}$$

t'_{d-n50} , t'_{s-n50} , t'_{b-n50} : Mean thickness (m) of deck, ship sides and bottom. When calculating mean thickness, only the strong deck, side shell plating, bottom shell plating, inner bottom plating, and longitudinal bulkheads is to be used, and other longitudinal members are not to be included.

Fig. 5.5.3-1 Mean Thickness of Deck, Ship Sides, and Bottom

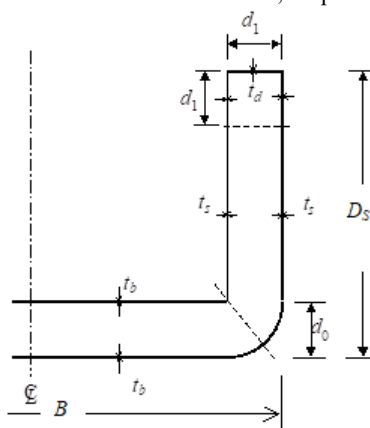

5.5.3.3 Evaluated Stress

Evaluated stress σ_T is to be determined in accordance with the following formula:

$$\sigma_T = \sqrt{(0.75\sigma_{WV})^2 + \sigma_{WH}^2 + \sigma_{WT}^2} + \sigma_{SV} + \sigma_{ST}$$

σ_{SV} : Stress due to the vertical still water bending moment (N/mm^2) specified in 5.5.3.2 (1).

σ_{WV} : Stress due to vertical wave bending moment (N/mm^2), specified in 5.5.3.2 (2).

σ_{WH} : Stress due to horizontal wave bending moment (N/mm^2), specified in 5.5.3.2 (3).

σ_{ST} : Warping stress due to still water torsional moment (N/mm^2), specified in 5.5.3.2 (4).

σ_{WT} : Warping stress due to wave torsional moment (N/mm^2), specified in 5.5.3.2 (5).

5.5.3.4 Evaluation

The evaluated stress σ_T (N/mm^2) at any cross-sectional position from the collision bulkhead to watertight bulkhead of the fore end of the machinery room is to satisfy the following criteria.

$$\sigma_T \leq \frac{190}{K}$$

Annex 5.3 BUCKLING STRENGTH ASSESSMENT RELATING TO LONGITUDINAL STRENGTH (UR S11A)

Symbols

- x : Local axis of a rectangular buckling panel parallel to its long edge.
- y : Local axis of a rectangular buckling panel perpendicular to its long edge.
- σ_x : Stress (N/mm^2) applied on the edge along x axis of the buckling panel.
- σ_y : Stress (N/mm^2) applied on the edge along y axis of the buckling panel.
- τ : Applied shear stress (N/mm^2).
- σ_a : Critical stress (N/mm^2), defined in [An2.4.4-2](#).
- σ_b : Bending stress (N/mm^2), in the stiffener, defined in [An2.4.4-3](#).
- σ_w : Stress (N/mm^2) due to torsional deformation, defined in [An2.4.4-4](#).
- σ_{cx} , σ_{cy} , τ_c : Critical stress (N/mm^2), defined in [An2.2.1-1](#).
- σ_{YS} : Specified minimum yield stress (N/mm^2) of the stiffener, defined in [An2.4.4-1](#).
- σ_{YP} : Specified minimum yield stress (N/mm^2) of the plate.
- a : Length of the longer side of the plate panel. (mm) (See [Table An2](#))
- b : Length of the shorter side of the plate panel. (mm) (See [Table An2](#))
- d : Length of the side parallel to the axis of the cylinder corresponding to the curved plate panel as shown in [Table An3](#).
- σ_E : Elastic buckling reference stress (N/mm^2), to be taken as:
 For the application of plate limit state according to [An2.2.1-2](#):

$$\sigma_E = \frac{\pi^2 E}{12(1 - \nu^2)} \left(\frac{t_p}{b} \right)^2$$
 For the application of curved plate panels according to [An2.2.2](#):

$$\sigma_E = \frac{\pi^2 E}{12(1 - \nu^2)} \left(\frac{t_p}{d} \right)^2$$
- ν : Poisson's ratio, taken as 0.3.
- t_p : Thickness (mm) of plate panel.
- t_w : Stiffener web thickness (mm).
- t_f : Flange thickness (mm).
- b_f : Breadth (mm) of the stiffener flange.
- h_w : Depth (mm) of stiffener web.
- e_f : Distance (mm) from attached plating to centre of flange, to be taken as follows:
 $e_f = h_w$ for flat bar profile.
 $e_f = h_w - 0.5t_f$ for bulb profile.
 $e_f = h_w + 0.5t_f$ for angle and Tee profiles.
- α : Aspect ratio of the plate panel, to be taken as follows:

$$\alpha = \frac{a}{b}$$
- β : Coefficient taken as follows:

$$\beta = \frac{1 - \psi}{\alpha}$$
- ψ : Edge stress ratio to be taken as follows:

$$\psi = \frac{\sigma_2}{\sigma_1}$$
- γ : Stress multiplier factor acting on loads. When the factor is such that the loads reach the interaction formulae, $\gamma = \gamma_c$.
- γ_c : Stress multiplier factor at failure.
- σ_1 : Maximum stress (N/mm^2).
- σ_2 : Minimum stress (N/mm^2).
- R : Radius (mm) of curved plate panel.

- E : Young's modulus, to be taken as 2.06×10^5 (N/mm^2).
- l : Span (mm) of stiffener equal to spacing between primary supporting members.
- s : Spacing (mm) of stiffener to be taken as the mean spacing between the stiffeners of the considered stiffened panel.

An1. General

An1.1 General

An1.1.1 Overview

- Annex 5.3** specifies how to carry out the buckling strength assessment regarding the longitudinal strength of container carriers.
- The stresses σ_x and σ_y given in **Annex 5.3** are to be taken as positive when they are compressive stresses and zero when they are tensile stresses.

An1.1.2 Calculation of Buckling Utilisation Factor

The buckling utilisation factor is to be taken as follows:

$$\eta_{act} = \frac{1}{\gamma_c}$$

γ_c : Stress multiplier factor at failure. Buckling strength assessment for plate is to be in accordance with **An2.2.1** or **An2.2.2** and buckling strength assessment for stiffener is to be in accordance with **An2.3.1** and **An2.4.4**.

An2. Buckling Strength Assessment of Each Structural Member

An2.1 Elementary Plate Panel (EPP)

An2.1.1 Definitions

An Elementary Plate Panel (*EPP*) is the part of the plating between stiffeners and/or primary supporting members. All the edges of the elementary plate panel are forced to remain straight (but free to move in the in-plane directions) due to the surrounding structure/neighbouring plates (usually longitudinal stiffened panels in deck, bottom, and inner bottom plating, shell and longitudinal bulkheads).

An2.1.2 EPP with Different Thickness

1 In longitudinal stiffening arrangement, when the plate thickness varies over the width b of a plate panel, the buckling capacity is calculated on an equivalent plate panel width, having a thickness equal to the smaller plate thickness t_1 . The width of this equivalent plate panel b_{eq} is defined by the following formula:

$$b_{eq} = l_1 + l_2 \left(\frac{t_1}{t_2} \right)^{1.5}$$

l_1 : Width of the part of the plate panel with the smaller plate thickness t_1 (mm), as defined in **Fig. An1**.

l_2 : Width of the part of the plate panel with the greater plate thickness t_2 (mm) as defined in **Fig. An1**.

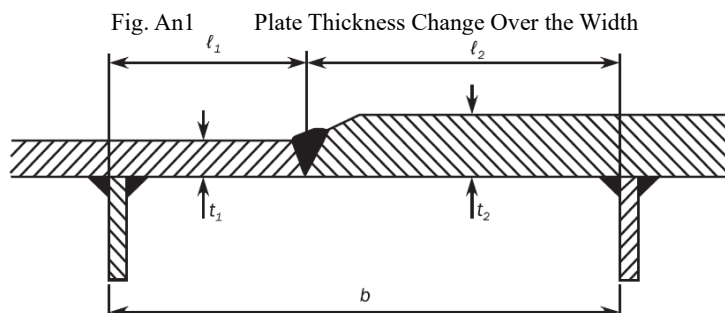

2 In a transverse stiffening arrangement, when an *EPP* is made of different thicknesses, the buckling check of the plate and stiffeners is to be made for each thickness considered constant on the *EPP*.

An2.2 Buckling Capacity of Plates

An2.2.1 Plate Panel

1 The plate limit state is based on the following interaction formulae:

- (1) In the case of a longitudinal stiffening arrangement

$$\left(\frac{\gamma_c \sigma_x}{\sigma_{cx}}\right)^{2/\beta_p^{0.25}} + \left(\frac{\gamma_c |\tau|}{\tau_c}\right)^{2/\beta_p^{0.25}} = 1$$

- (2) In the case of a transverse stiffening arrangement

$$\left(\frac{\gamma_c \sigma_y}{\sigma_{cy}}\right)^{2/\beta_p^{0.25}} + \left(\frac{\gamma_c |\tau|}{\tau_c}\right)^{2/\beta_p^{0.25}} = 1$$

σ_{cx} : Ultimate buckling stress (N/mm^2) in direction parallel to the longer edge of the buckling panel as defined in -3.

σ_{cy} : Ultimate buckling stress (N/mm^2) in direction parallel to the shorter edge of the buckling panel as defined in -3.

τ_c : Ultimate buckling shear stress (N/mm^2), as defined in -3.

β_p : Plate slenderness parameter taken as:

$$\beta_p = \frac{b}{t_p} \sqrt{\frac{\sigma_{YP}}{E}}$$

- 2 The reference degree of slenderness λ is to be taken as:

$$\lambda = \sqrt{\frac{\sigma_{YP}}{K \sigma_E}}$$

K : Buckling factor, as defined in [Tables An2](#) and [An3](#).

- 3 The ultimate buckling stress is in accordance with the following:

- (1) The ultimate buckling stress of plate panel σ_{cx} and σ_{cy} (N/mm^2), is to be taken as:

$$\sigma_{cx} = C_x \sigma_{YP}$$

$$\sigma_{cy} = C_y \sigma_{YP}$$

- (2) The ultimate buckling stress of plate panels subject to shear τ_c (N/mm^2), is to be taken as

$$\tau_c = C_\tau \frac{\sigma_{YP}}{\sqrt{3}}$$

C_x , C_y , C_τ : Reduction factors, as defined in [Table An2](#).

- (3) The boundary conditions for plates are to be considered as simply supported (*See* cases 1, 2 and 15 of [Table An2](#)). If the boundary conditions differ significantly from simple support, a more appropriate boundary condition can be applied according to the different cases of [Table An2](#) subject to the approval by the Society.

4 The correction factor F_{long} depending on the edge stiffener types on the longer side of the buckling panel is defined in [Table An1](#). An average value of F_{long} is to be used for plate panels having different edge stiffeners. For stiffener types other than those mentioned in [Table An1](#), the value of c is to be agreed by the Society. In such a case, value of c higher than those mentioned in [Table An1](#) can be used, provided the value c is verified by buckling strength check of panel using nonlinear FE analysis and deemed appropriate by Society.

Table An1 Correction Factor F_{long}



Structural element types		F_{long}	c	
Unstiffened panel		1.0	N/A	
Stiffened panel	Stiffener not fixed at both ends	1.0	N/A	
	Stiffener fixed at both ends	Flat bar ⁽¹⁾	$F_{long} = c + 1$ for $\frac{t_w}{t_p} > 1$ $F_{long} = c \left(\frac{t_w}{t_p}\right)^3 + 1$ for $\frac{t_w}{t_p} \leq 1$	0.10
		Bulb profile		0.30
		Angle profile		0.40
		T profile		0.30
Girder of high rigidity (e.g. bottom transverse)		1.4	N/A	

Note 1: t_w is the web thickness (mm), without the correction defined in [An2.4.3-5](#).

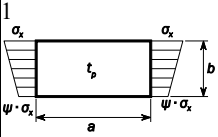
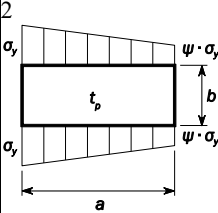
Table An2 Buckling Factor and Reduction Factor for Plane Plate Panels

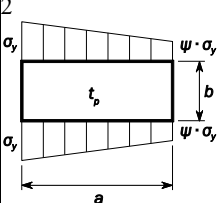
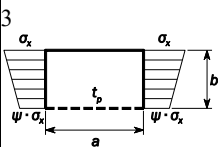
Load case	Stress ratio ψ	Aspect ratio α	Buckling factor K	Reduction factor C
	$\psi \geq 0$ $1 \geq \psi \geq -1$		$K_x = F_{long} \frac{8.4}{\psi + 1.1}$	For $\sigma_x \leq 0$ $C_x = 1$
	$0 \geq \psi > -1$		$K_x = F_{long} [7.63 - \psi(6.26 - 10\psi)]$	For $\sigma_x > 0$ Where $\lambda \leq \lambda_c$ $C_x = 1$ Where $\lambda > \lambda_c$
	$\psi \leq -1$		$K_x = F_{long} [5.975 (1 - \psi)^2]$	$C_x = c \left(\frac{1}{\lambda} - \frac{0.22}{\lambda^2} \right)$ $c = (1.25 - 0.12\psi) \leq 1.25$ $\lambda_c = \frac{c}{2} \left(1 + \sqrt{1 - \frac{0.88}{c}} \right)$
	$1 \geq \psi \geq 0$		$K_y = \frac{2 \left(1 + \frac{1}{\alpha^2} \right)^2}{1 + \psi + \frac{(1 - \psi)}{100} \left(\frac{2.4}{\alpha^2} + 6.9f_1 \right)}$	For $\sigma_y \leq 0$ $C_y = 1$
		$\alpha \leq 6$	$f_1 = (1 - \psi)(\alpha - 1)$	For $\sigma_y > 0$ $C_y = c \left(\frac{1}{\lambda} - \frac{R + F^2(H - R)}{\lambda^2} \right)$
		$\alpha > 6$	$f_1 = 0.6 \left(1 - \frac{6\psi}{\alpha} \right) \left(\alpha + \frac{14}{\alpha} \right)$ not to be greater than $14.5 - \frac{0.35}{\alpha^2}$	$c = (1.25 - 0.12\psi) \leq 1.25$
	$\frac{4\alpha}{3} > \psi \geq 1 - \frac{3}{3}$		$K_y = \frac{200(1 + \beta^2)^2}{(1 - f_3)(100 + 2.4\beta^2 + 6.9f_1 + 23f_2)}$	For $\lambda < \lambda_c$ $R = \lambda(1 - \lambda/c)$ For $\lambda \geq \lambda_c$ $R = 0.22$
		$\alpha > 6(1 - \psi)$	$f_1 = 0.6 \left(\frac{1}{\beta} + 14\beta \right)$ not to be greater than $14.5 - 0.35\beta^2$ $f_2 = f_3 = 0$	$\lambda_c = 0.5c \left(1 + \sqrt{1 - 0.88/c} \right)$ $F = \left[1 - \left(\frac{K}{0.91} - 1 \right) / \lambda_p^2 \right] c_1 \geq 0$
		$3(1 - \psi) \leq \alpha \leq 6(1 - \psi)$	$f_1 = \frac{1}{\beta} - 1$ $f_2 = f_3 = 0$	For $1 \leq \lambda_p^2 \leq 3$ $\lambda_p^2 = \lambda^2 - 0.5$ $c_1 = 1 - \frac{1}{\alpha} \geq 0$ $H = \lambda - \frac{2\lambda}{c(T + \sqrt{T^2 - 4})} \geq R$ $T = \lambda + \frac{14}{15\lambda} + \frac{1}{3}$

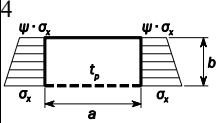
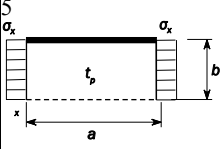
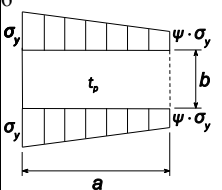
Load case	Stress ratio ψ	Aspect ratio α	Buckling factor K	Reduction factor C
	$0 > \psi \geq 1 - \frac{4\alpha}{3}$	$1.5(1 - \psi) \leq \alpha < 3(1 - \psi)$	$f_1 = \frac{1}{\beta} - (2 - \omega\beta)^4 - 9(\omega\beta - 1) \left(\frac{2}{3} - \beta \right)$ $f_2 = f_3 = 0$	For $\sigma_y \leq 0$ $C_y = 1$
		$1 - \psi \leq \alpha < 1.5(1 - \psi)$	For $\alpha > 1.5$ $f_1 = 2 \left[\frac{1}{\beta} - 16 \left(1 - \frac{\omega}{3} \right)^4 \right] \left(\frac{1}{\beta} - 1 \right)$ $f_2 = 3\beta - 2$ $f_3 = 0$ For $\alpha \leq 1.5$ $f_1 = 2 \left(\frac{1.5}{1 - \psi} - 1 \right) \left(\frac{1}{\beta} - 1 \right)$ $f_2 = \frac{\psi(1 - 16f_4^2)}{1 - \alpha}$ $f_3 = 0$ $f_4 = (1.5 - \min(1.5, \alpha))^2$	For $\sigma_y > 0$ $C_y = c \left(\frac{1}{\lambda} - \frac{R + F^2(H - R)}{\lambda^2} \right)$ $c = (1.25 - 0.12\psi) \leq 1.25$ For $\lambda < \lambda_c$ $R = \lambda(1 - \lambda/c)$ For $\lambda \geq \lambda_c$ $R = 0.22$ $\lambda_c = 0.5c(1 + \sqrt{1 - 0.88/c})$
		$0.75(1 - \psi) \leq \alpha < 1 - \psi$	$f_1 = 0$ $f_2 = 1 + 2.31(\beta - 1) - 48 \left(\frac{4}{3} - \beta \right) f_4^2$ $f_3 = 3f_4(\beta - 1) \left(\frac{f_4}{1.81} - \frac{\alpha - 1}{1.31} \right)$ $f_4 = (1.5 - \min(1.5, \alpha))^2$	$F = \left[1 - \left(\frac{K}{0.91} - 1 \right) / \lambda_p^2 \right] c_1 \geq 0$ For $1 \leq \lambda_p^2 \leq 3$ $\lambda_p^2 = \lambda^2 - 0.5$ $c_1 = 1 - \frac{1}{\alpha} \geq 0$ $H = \lambda - \frac{2\lambda}{c(T + \sqrt{T^2 - 4})} \geq R$ $T = \lambda + \frac{14}{15\lambda} + \frac{1}{3}$
$\psi < 1 - \frac{4\alpha}{3}$	$K_y = 5.972 \frac{\beta^2}{1 - f_3}$ $f_3 = f_5 \left(\frac{f_5}{1.81} + \frac{1 + 3\psi}{5.24} \right)$ $f_5 = \frac{9}{16} (1 + \max(-1, \psi))^2$			
	$1 \geq \psi \geq 0$	$K_x = \frac{4(0.425 + 1/\alpha^2)}{3\psi + 1}$	For $\lambda \leq 0.7$ $C_x = 1$	
	$0 > \psi \geq -1$	$K_x = 4(0.425 + 1/\alpha^2)(1 + \psi) - 5\psi(1 - 3.42\psi)$	For $\lambda > 0.7$ $C_x = \frac{1}{\lambda^2 + 0.51}$	

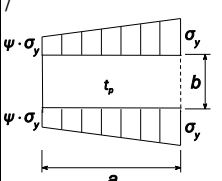
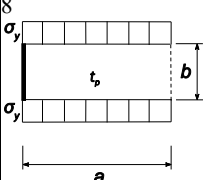
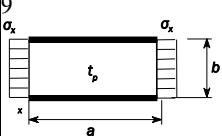
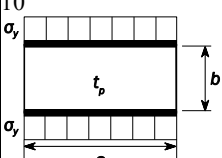
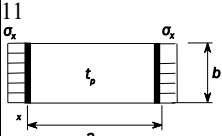
Load case	Stress ratio ψ	Aspect ratio α	Buckling factor K	Reduction factor C
	$\psi \geq 1$ $\psi \leq -1$		$K_x = \left(0.425 + \frac{1}{\alpha^2}\right) \frac{3 - \psi}{2}$	For $\lambda \leq 0.7$ $C_x = 1$ For $\lambda > 0.7$ $C_x = \frac{1}{\lambda^2 + 0.51}$
	-	$\alpha \geq 1.64$	$K_x = 1.28$	
		$\alpha < 1.64$	$K_x = \frac{1}{\alpha^2} + 0.56 + 0.13\alpha^2$	
	$\psi \geq 0$ $\psi \leq -1$		$K_y = \frac{4(0.425 + \alpha^2)}{(3\psi + 1)\alpha^2}$	For $\lambda \leq 0.7$ $C_y = 1$ For $\lambda > 0.7$ $C_y = \frac{1}{\lambda^2 + 0.51}$
	$0 > \psi \geq -1$		$K_y = 4(0.425 + \alpha^2)(1 + \psi) \frac{1}{\alpha^2}$ $-5\psi(1 - 3.42\psi) \frac{1}{\alpha^2}$	
	$\psi \geq 1$ $\psi \leq -1$		$K_y = 4(0.425 + \alpha^2) \frac{(3 - \psi)}{2\alpha^2}$	
	-		$K_y = 1 + \frac{0.56}{\alpha^2} + \frac{0.13}{\alpha^4}$	
	-		$K_x = 6.97$	For $\lambda \leq 0.83$ $C_x = 1$ For $\lambda > 0.83$ $C_x = 1.13 \left(\frac{1}{\lambda} - \frac{0.22}{\lambda^2} \right)$
	-		$K_y = 4 + \frac{2.07}{\alpha^2} + \frac{0.67}{\alpha^4}$	
	-	$\alpha \geq 4$	$K_x = 4$	
		$\alpha < 4$	$K_x = 4 + 2.74 \left(\frac{4 - \alpha}{3} \right)^4$	

Load case	Stress ratio ψ	Aspect ratio α	Buckling factor K	Reduction factor C
12 	-		K_y K_y determined as per case 2	For $\alpha < 2$ $C_y = C_{y2}$ For $\alpha \geq 2$ $C_y = \left(1.06 + \frac{1}{10\alpha}\right) C_{y2}$ $C_{y2} : C_y$ determined as per case 2
13 	-	$\alpha \geq 4$	$K_x = 6.97$	For $\lambda \leq 0.83$ $C_x = 1$
		$\alpha < 4$	$K_x = 6.97 + 3.1 \left(\frac{4 - \alpha}{3}\right)^4$	For $\lambda > 0.83$ $C_x = 1.13 \left(\frac{1}{\lambda} - \frac{0.22}{\lambda^2}\right)$
14 	-		$K_y = \frac{6.97}{\alpha^2} + \frac{3.1}{\alpha^2} \left(\frac{4 - 1/\alpha}{3}\right)^4$	For $\lambda \leq 0.83$ $C_y = 1$ For $\lambda > 0.83$ $C_y = 1.13 \left(\frac{1}{\lambda} - \frac{0.22}{\lambda^2}\right)$
15 	-		$K_\tau = \sqrt{3} \left[5.34 + \frac{4}{\alpha^2}\right]$	
16 	-		$K_\tau = \sqrt{3} \left[5.34 + \max\left(\frac{4}{\alpha^2}, \frac{7.15}{\alpha^{2.5}}\right)\right]$	For $\lambda \leq 0.84$ $C_\tau = 1$ For $\lambda > 0.84$ $C_\tau = \frac{0.84}{\lambda}$
17 	-		$K_\tau = K_{\tau \text{ case15}} r$ $K_{\tau \text{ case15}} : K_\tau$ according to case 15 r : Opening reduction factor taken as: with $\frac{d_a}{a} \leq 0.7$ and $\frac{d_b}{b} \leq 0.7$ $r = \left(1 - \frac{d_a}{a}\right) \left(1 - \frac{d_b}{b}\right)$	
18 	-		$K_\tau = \sqrt{3} (0.6 + 4/\alpha^2)$	For $\lambda \leq 0.84$ $C_\tau = 1$
19 	-		$K_\tau = 8$	For $\lambda > 0.84$ $C_\tau = \frac{0.84}{\lambda}$

Load case	Stress ratio ψ	Aspect ratio α	Buckling factor K	Reduction factor C
Edge boundary conditions:				
----- Plate edge free. _____ Plate edge simply supported. _____ Plate edge clamped.				
Notes:				
F_{long} : Coefficient, as defined in An2.2.1-4 . ω : Coefficient to be taken as: $\omega = \min(3, \alpha)$				
(1) Cases listed are general cases. Each stress component (σ_x , σ_y) is to be understood in local coordinates.				

An2.2.2 Curved Plate Panels

1 This requirement for curved plate limit state is applicable when $R/t_p \leq 2500$. Otherwise, the requirement for plate limit state given in [An2.2.1-1](#) is applicable.

2 The curved plate limit state is based on the following interaction formula: The stress multiplier factor, γ_c , of the curved plate panel need not be taken less than the stress multiplier factor, γ_c , for the expanded plane panel according to [An2.2.1-1](#).

$$\left(\frac{\gamma_c \sigma_{ax}}{C_{ax} \sigma_{YP}}\right)^{1.25} + \left(\frac{\gamma_c \tau \sqrt{3}}{C_\tau \sigma_{YP}}\right)^2 = 1.0$$

σ_{ax} : Applied axial stress to the cylinder corresponding to the curved plate panel (N/mm^2). In case of tensile axial stresses to be taken as zero.

C_{ax} , C_τ : Buckling reduction factor of the curved plate panel, as defined in [Table An3](#).

Table An3 Buckling Factor and Reduction Factor for Curved Plate Panels

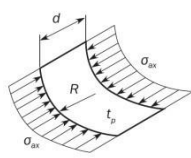
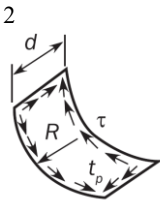
Case	Aspect ratio	Buckling factor K	Reduction factor C
1 	$\frac{d}{R} \leq 0.5 \sqrt{\frac{R}{t_p}}$	$K = 1 + \frac{2}{3} \frac{d^2}{R t_p}$	For general application: $C_{ax} = 1$ for $\lambda \leq 0.25$ $C_{ax} = 1.233 - 0.933\lambda$ for $0.25 < \lambda \leq 1$ $C_{ax} = 0.3/\lambda^3$ for $1 < \lambda \leq 1.5$ $C_{ax} = 0.2/\lambda^2$ for $\lambda > 1.5$ For curved single fields, e.g. bilge plating, which are bounded by plane panels: $C_{ax} = \frac{0.65}{\lambda^2} \leq 1.0$
	$\frac{d}{R} > 0.5 \sqrt{\frac{R}{t_p}}$	$K = 0.267 \frac{d^2}{R t_p} \left[3 - \frac{d}{R} \sqrt{\frac{t_p}{R}} \right]$ $\geq 0.4 \frac{d^2}{R t_p}$	
2 	$\frac{d}{R} \leq 8.7 \sqrt{\frac{R}{t_p}}$	$K = \sqrt{3} \sqrt{28.3 + \frac{0.67 d^3}{R^{1.5} t_p^{1.5}}}$	$C_\tau = 1$ for $\lambda \leq 0.4$ $C_\tau = 1.274 - 0.686\lambda$ for $0.4 < \lambda \leq 1.2$ $C_\tau = \frac{0.65}{\lambda^2}$ for $\lambda > 1.2$
	$\frac{d}{R} > 8.7 \sqrt{\frac{R}{t_p}}$	$K = \sqrt{3} \frac{0.28 d^2}{R \sqrt{R t_p}}$	
Explanations for boundary conditions: _____ Plate edge free			

An2.3 Buckling Capacity of Overall Stiffened Panel

An2.3.1

The elastic stiffened panel limit state is based on the following interaction formula:

$$\frac{P_z}{c_f} = 1$$

Where c_f and P_z are defined in [An2.4.4-3](#),

An2.4 Buckling Capacity of Longitudinal Stiffeners

An2.4.1 Stiffener Limit States

The buckling capacity of longitudinal stiffeners is to be checked for the following limit states:

- (1) Stiffener induced failure (*SI*)
- (2) Plate induced failure (*PI*)

An2.4.2 Lateral Pressure

The lateral pressure is to be considered as constant in the buckling strength assessment of longitudinal stiffeners.

An2.4.3 Stiffener Idealization

- 1 The effective length of the stiffener l_{eff} (*mm*), is to be taken equal to:

$$l_{eff} = \frac{l}{\sqrt{3}} \text{ for stiffener fixed at both ends.}$$

$$l_{eff} = 0.75l \text{ for stiffener simply supported at one end and fixed at the other.}$$

$$l_{eff} = l \text{ for stiffener simply supported at both ends.}$$

- 2 The effective width of the attached plating of a stiffener b_{eff1} (*mm*), without the shear lag effect is to be taken equal to:

$$b_{eff1} = \frac{C_{x1}b_1 + C_{x2}b_2}{2}$$

C_x : Reduction factor defined in [Table An2](#).

C_{x1}, C_{x2} : Reduction factor defined in [Table An2](#) calculated for the *EPP1* and *EPP2* on each side of the considered stiffener according to case 1.

b_1, b_2 : Width of plate panel on each side of the considered stiffener (*mm*).

- 3 The effective width of attached plating of stiffeners, b_{eff} (*mm*), is to be taken as:

$$b_{eff} = \min\left(\frac{C_{x1}b_1 + C_{x2}b_2}{2}, \chi_s s\right)$$

C_x : Reduction factor defined in [Table An2](#).

C_{x1}, C_{x2} : Reduction factor defined in [Table An2](#) calculated for the *EPP1* and *EPP2* on each side of the considered stiffener according to case 1.

b_1, b_2 : Width of plate panel on each side of the considered stiffener, (*mm*).

χ_s : Effective width coefficient to be taken as:

$$\text{For } \frac{l_{eff}}{s} \geq 1, \chi_s = \min\left(\frac{1.12}{1 + \frac{1.75}{\left(\frac{l_{eff}}{s}\right)^{1.6}}}, 1.0\right)$$

$$\text{For } \frac{l_{eff}}{s} < 1, \chi_s = 0.407 \frac{l_{eff}}{s}$$

l_{eff} : Effective length of the stiffener (*mm*), as specified in -1.

- 4 Thickness of attached plating t_p , is to be taken equal to the mean thickness of the two panels adjacent to the stiffener under consideration.

- 5 For accounting the decrease of stiffness due to local lateral deformation, the effective web thickness of flat bar stiffener, t_{w_red} (*mm*), is to be used for the calculation of the sectional area, A_s , the section modulus, Z , and the moment of inertia, I , of the stiffener and is taken as:

$$t_{w_red} = t_w \left[1 - \frac{2\pi^2}{3} \left(\frac{h_w}{s}\right)^2 \left(1 - \frac{b_{eff1}}{s}\right) \right]$$

- 6 The section modulus Z of a stiffener (cm^3), including effective width of plating is to be taken equal to:

- (1) For stiffener induced failure (*SI*), the section modulus Z is to be calculated at the top of stiffener flange.
- (2) For plate induced failure (*PI*), the section modulus Z is to be calculated at the attached plating.

7 The moment of inertia I (cm^4) of a stiffener including effective width of attached plating is to comply with the following requirement:

$$I \geq \frac{st_p^3}{12 \times 10^4}$$

8 Bulb profiles may be considered as equivalent angle profiles. The dimensions of the equivalent built-up section are to be obtained from the following formulae.

$$h_w = h'_w - \frac{h'_w}{9.2} + 2(mm)$$

$$b_f = \alpha \left(t'_w + \frac{h'_w}{6.7} - 2 \right) (mm)$$

$$t_f = \frac{h'_w}{9.2} - 2(mm)$$

$$t_w = t'_w (mm)$$

h'_w , t'_w : Height and thickness of a bulb section (mm), as shown in Fig. An2.

α : Coefficient equal to:

$$\alpha = 1.1 + \frac{(120 - h'_w)^2}{3000} \text{ for } h'_w \leq 120$$

$$\alpha = 1.0 \text{ for } h'_w > 120$$

Fig. An2 Idealisation of Bulb Stiffener

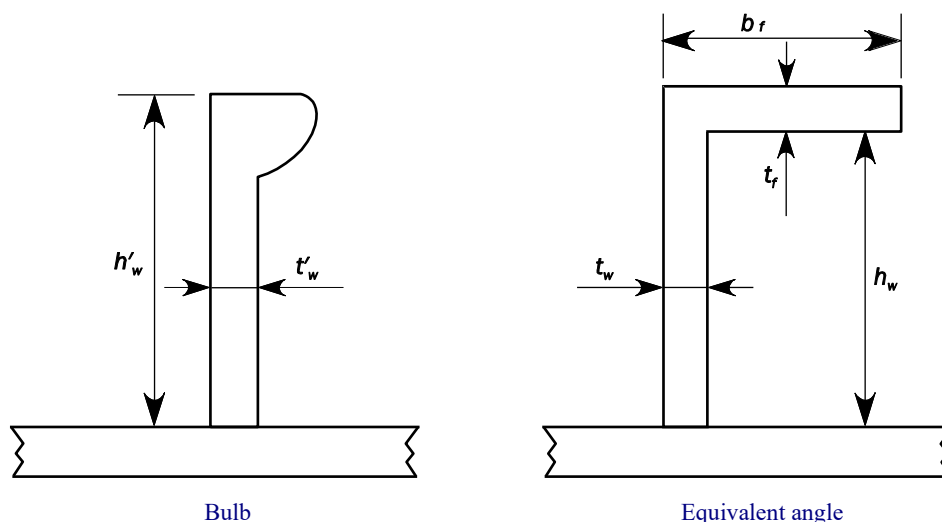

An2.4.4 Ultimate Buckling Capacity

1 Longitudinal Stiffener Limit State

When $\sigma_a + \sigma_b + \sigma_w > 0$, the ultimate buckling capacity for stiffener is to be checked according to the following interaction formula:

$$\frac{\gamma_c \sigma_a + \sigma_b + \sigma_w}{\sigma_Y} = 1$$

σ_a : Effective axial stress (N/mm^2) at mid-span of the stiffener, defined in -2.

σ_b : Bending stress in the stiffener (N/mm^2) defined in -3.

σ_w : Stress due to torsional deformation (N/mm^2) defined in -4.

σ_Y : Specified minimum yield stress of the material (N/mm^2).

$$\sigma_Y = \sigma_{YS} \text{ for stiffener induced failure (SI)}$$

$$\sigma_Y = \sigma_{YP} \text{ for plate induced failure (PI)}$$

2 The effective axial stress σ_a (N/mm^2), at mid-span of the stiffener, acting on the stiffener with its attached plating is to be taken equal to:

$$\sigma_a = \sigma_x \frac{st_p + A_s}{b_{eff1} t_p + A_s}$$

σ_x : The nominal axial stress (N/mm^2) that acts on the stiffener with attached plating, and is the axial stress calculated at the load calculation point of the stiffener.

b_{eff1} : The effective width of the attached plating of a stiffener without the shear lag effect, according to [An2.4.3-2](#).

A_s : Sectional area (mm^2) of the considered stiffener.

- 3 The bending stress in the stiffener σ_b (N/mm^2), is to be taken equal to:

$$\sigma_b = \frac{M_0 + M_1}{Z} 10^{-3}$$

Z : Section modulus of stiffener Z (cm^3), including effective width of plating, according to [An2.4.3-6](#).

M_1 : Bending moment ($N\text{-}mm$) due to the lateral load P , is to be taken as:

$$M_1 = C_i \frac{|P|s l^2}{24} 10^{-3} \text{ for continuous stiffener}$$

$$M_1 = C_i \frac{|P|s l^2}{8} 10^{-3} \text{ for sniped stiffener}$$

P : Lateral load (kN/m^2), which is the hydrostatic pressure at the load calculation point of the stiffener.

C_i : Pressure coefficient, is to be taken as:

$$C_i = C_{SI} \text{ for stiffener induced failure (SI)}$$

$$C_i = C_{PI} \text{ for plate induced failure (PI)}$$

C_{PI} : Plate induced failure pressure coefficient, is to be taken as:

$$C_{PI} = 1 \text{ if the lateral pressure is applied on the side opposite to the stiffener.}$$

$$C_{PI} = -1 \text{ if the lateral pressure is applied on the same side as the stiffener.}$$

C_{SI} : Plate induced failure pressure coefficient:

$$C_{SI} = -1 \text{ if the lateral pressure is applied on the side opposite to the stiffener.}$$

$$C_{SI} = 1 \text{ if the lateral pressure is applied on the same side as the stiffener.}$$

M_0 : Bending moment ($N\text{-}mm$) due to the lateral deformation w of the stiffener:

$$M_0 = F_E \left(\frac{P_z w}{c_f - P_z} \right) \quad c_f - P_z > 0$$

F_E : Ideal elastic buckling force of the stiffener, in N :

$$F_E = \left(\frac{\pi}{l} \right)^2 EI 10^4 \quad F_E = \left(\frac{\pi}{l} \right)^2 EI 10^4$$

P_z : Nominal lateral load (N/mm^2), acting on the stiffener due to stress σ_x , σ_y and τ in the attached plating in way of the stiffener mid span:

$$P_z = \frac{t_p}{S} \left(\sigma_{xl} \left(\frac{\pi S}{l} \right)^2 + \sqrt{2} \tau_1 \right)$$

$$\sigma_{xl} = \gamma \sigma_x \left(1 + \frac{A_s}{s t_p} \right) \quad \text{but not less than 0}$$

$$\tau_1 = \gamma |\tau| - t_p \sqrt{\sigma_{YP} E \left(\frac{m_1}{a^2} + \frac{m_2}{s^2} \right)} \quad \text{but not less than 0}$$

τ : Applied shear stress (N/mm^2), which is the shear stress calculated at the load calculation point of the stiffener with attached plating.

m_1 , m_2 : Coefficients taken equal to:

$$m_1 = 1.47, \text{ for } \alpha \geq 2 \quad m_2 = 0.49$$

$$m_1 = 1.96, \quad m_2 = 0.37 \text{ for } \alpha < 2$$

w : Deformation of stiffener (mm):

$$w = w_0 + w_1$$

w_0 : Assumed imperfection (mm), to be taken as:

$$w_0 = 0.001l \text{ in general}$$

$$w_0 = -w_{na} \text{ for stiffeners sniped at both ends considering stiffener induced failure (SI)}$$

$$w_0 = w_{na} \text{ for stiffeners sniped at both ends considering plate induced failure (PI)}$$

w_{na} : Distance from the mid-point of attached plating to the neutral axis of the stiffener calculated with the effective width of the attached plating.

w_1 : Deformation of stiffener (mm), at mid-point of stiffener span due to lateral load P . In case of uniformly

distributed load, w_1 is taken as:

$$w_1 = C_i \frac{|P|s l^4}{384EI} 10^{-7} \text{ in general}$$

$$w_1 = C_i \frac{5|P|s l^4}{384EI} 10^{-7} \text{ for stiffeners sniped at both ends}$$

c_f : Elastic support provided by the stiffener (N/mm^2).

$$c_f = F_E \left(\frac{\pi}{l}\right)^2 (1 + c_p)$$

c_p : Coefficient to be taken as:

$$c_p = \frac{1}{1 + \frac{0.91}{c_{xa}} \left(\frac{12I}{st_p^3} 10^4 - 1\right)}$$

c_{xa} : Coefficient to be taken as:

$$c_{xa} = \left(\frac{l}{2s} + \frac{2s}{l}\right)^2 \text{ for } l \geq 2s$$

$$c_{xa} = \left[1 + \left(\frac{l}{2s}\right)^2\right]^2 \text{ for } l < 2s$$

4 The stress due to torsional deformation σ_w is to be taken equal to:

$$\sigma_w = Ey_w \left(\frac{t_f}{2} + h_w\right) \Phi_0 \left(\frac{\pi}{l}\right)^2 \left(\frac{1}{1 - \frac{0.4\sigma_{YS}}{\sigma_{ET}}} - 1\right) \text{ for stiffener induced failure (SI)}$$

$\sigma_w = 0$ for plate induced failure (PI)

y_w : Distance (mm), from centroid of stiffener cross section to the free edge of stiffener flange, to be taken as:

$$y_w = \frac{t_w}{2} \text{ for flat bar.}$$

$$y_w = b_f - \frac{h_w t_w^2 + t_f b_f^2}{2A_s} \text{ for angle and bulb profiles.}$$

$$y_w = \frac{b_f}{2} \text{ for T profile.}$$

Φ_0 : Coefficient to be taken as:

$$\Phi_0 = 0.001 \frac{l}{h_w}$$

σ_{ET} : Reference stress for torsional buckling (N/mm^2).

$$\sigma_{ET} = \frac{E}{I_p} \left(\frac{\varepsilon_{pw} \pi^2 I_\omega}{l^2} 10^2 + 0.385 I_T\right)$$

I_p : Polar moment of inertia of the stiffener about point C as shown in **Fig. An3**, as defined in **Table An4** (cm^4).

I_T : St. Venant's moment of inertia of the stiffener, as defined in **Table An4** (cm^4).

I_ω : Sectional moment of inertia of the stiffener about point C as shown in **Fig. An3**, as defined in **Table An3** (cm^6).

ε_{pw} : Degree of fixation, to be taken as:

$$\varepsilon_{pw} = 1 + \frac{\left(\frac{l}{\pi}\right)^2 10^{-3}}{\sqrt{I_\omega \left(\frac{0.75s}{t_p^3} + \frac{e_f - 0.5t_f}{t_w^3}\right)}}$$

Table An4 Moments of Inertia

	Flat bars	Bulb, angle and Tee profiles
I_p	$\frac{h_w^3 t_w}{3 \times 10^4}$	$\left(\frac{A_w (e_f - 0.5t_f)^2}{3} + A_f e_f^2 \right) 10^{-4}$
I_T	$\frac{h_w t_w^3}{3 \times 10^4} \left(1 - 0.63 \frac{t_w}{h_w} \right)$	$\frac{(e_f - 0.5t_f) t_w^3}{3 \times 10^4} \left(1 - 0.63 \frac{t_w}{e_f - 0.5t_f} \right) + \frac{b_f t_f^3}{3 \times 10^4} \left(1 - 0.63 \frac{t_f}{b_f} \right)$
I_w	$\frac{h_w^3 t_w^3}{36 \times 10^6}$	$\frac{A_f e_f^2 b_f^2}{12 \times 10^6} \left(\frac{A_f + 2.6A_w}{A_f + A_w} \right)$ for bulb and angle profiles $\frac{b_f^3 t_f e_f^2}{12 \times 10^6}$ for Tee profiles
A_w :	Web area (mm^2)	
A_f :	Flange area (mm^2)	

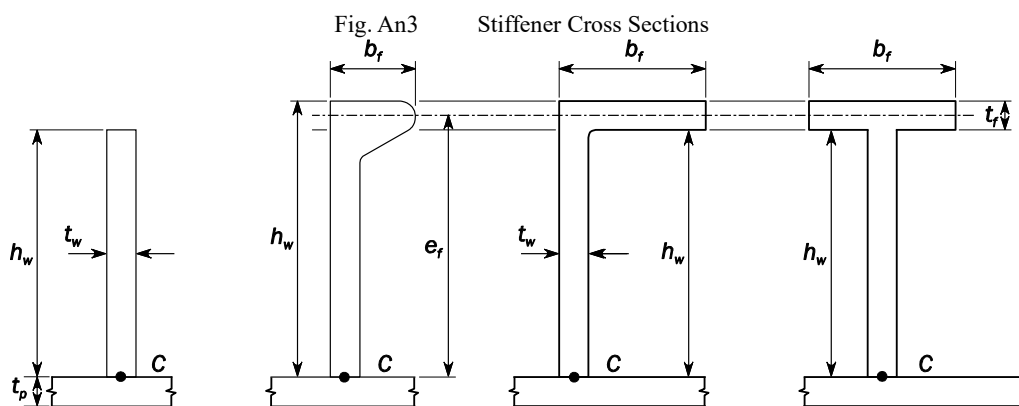

Annex 5.4 HULL GIRDER ULTIMATE STRENGTH ASSESSMENT CONSIDERING THE EFFECT OF LATERAL LOADS

An1. General

An1.1 Definitions

An1.1.1

Unless specified otherwise, the definitions of the symbols used in this Guidance are as specified in [Table An1](#).

Table An1 Definition of the Symbols

Symbol	Unit	Definition
Z_B	m^3	Section moduli at bottom
σ_{YS}	N/mm^2	Minimum yield stress of the material of the considered stiffener
σ_{YP}	N/mm^2	Minimum yield stress of the material of the considered plate
A_S	cm^2	Sectional area of stiffener, without attached plating
A_P	cm^2	Sectional area of attached plating
t	mm	Thickness of attached plating
b_f	mm	Face plate width of stiffener
t_f	mm	Face plate thickness of stiffener
h_w	mm	Web height of stiffener
t_w	mm	Web thickness of stiffener
l	mm	Length of longer side of attached plate
s	mm	Breadth of attached plate
E	N/mm^2	Young's modulus of steel, taken as 2.06×10^5 (N/mm^2)
ν	-	Poisson's ratio, taken as 0.3

An2. Evaluation Method of Hull Girder Ultimate Strength Considering the Effect of Lateral Loads

An2.1 Overview

An2.1.1

The procedure for evaluating hull girder ultimate strength in consideration of the effect of lateral loads is summarised in the flow chart in [Fig. An1](#).

Fig. An1 Evaluation Procedure

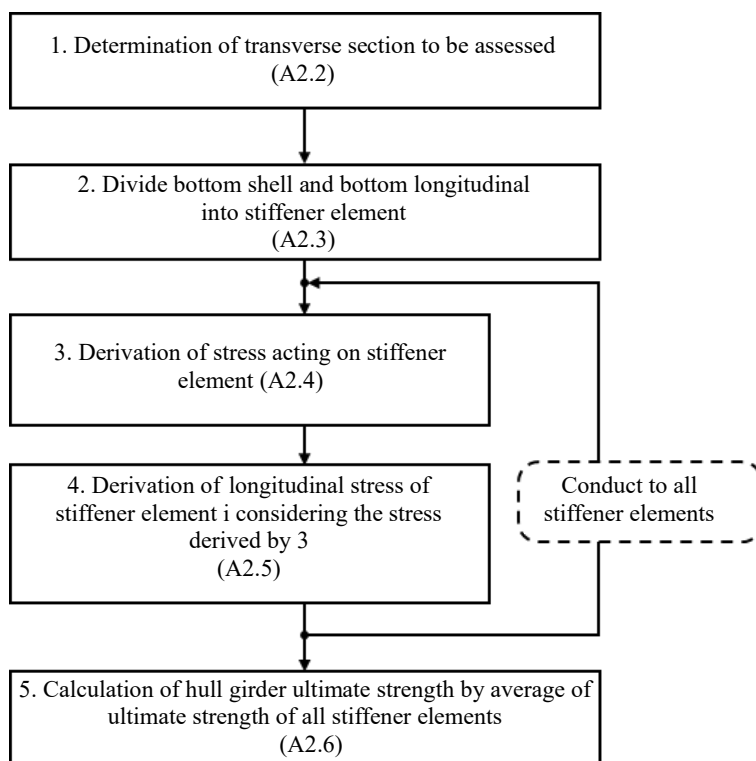

Note: Numbers in parentheses indicate section number

An2.2 Determination of Transverse Section to be Assessed

An2.2.1

“The transverse section located in the vicinity of the centre of the cargo hold at midship” in 5.4.3 refers to the transverse section where the bottom shell generates maximum longitudinal stress as calculated by the requirements of Chapter 8 under the condition specified in Table An2.

Table An2 Calculation condition

Loading condition	Wave load condition
One bay empty condition	HM-2

An2.3 Modelling of Stiffener Element

An2.3.1

Modelling of bottom shell and bottom longitudinals is to be in accordance with the following (1) to (3):

- (1) Bottom shell and bottom longitudinals in the span, which includes the hull girder transverse section specified in An2.2.1 above, between two adjacent transverse webs are to be modelled. However, bottom shell and bottom longitudinals at bilge parts and under bench corners are not to be included in the modelling.
- (2) The bottom shell and the bottom longitudinals being modelled specified in (1) above are to be divided into the stiffener element *i* consisting of a longitudinal and an attached plate. The attached plate width is to be equal to the mean spacing of the stiffeners. (See Fig. An2)
- (3) Where attached plating is made of steels having different thicknesses or yield stresses, an average thickness *t* (mm) or an average yield stress σ_{YP} (N/mm²) obtained from the following formulae are to be used for calculations. (See Fig. An3)

$$t = \frac{t_1 s'_1 + t_2 s'_2}{s}$$

$$\sigma_{YP} = \frac{\sigma_{YP1} t_1 s'_1 + \sigma_{YP2} t_2 s'_2}{t s}$$

- t_1, t_2 : Thickness of plate of attached plate (mm)
- $\sigma_{YP1}, \sigma_{YP2}$: Minimum yield stress of plate of attached plate (N/mm²)
- s'_1, s'_2 : Breadth of plate of attached plate (mm)

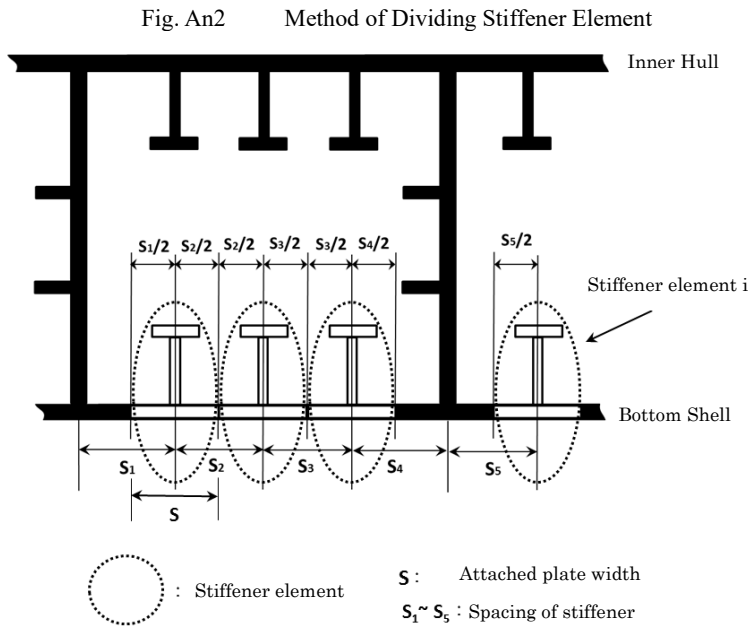
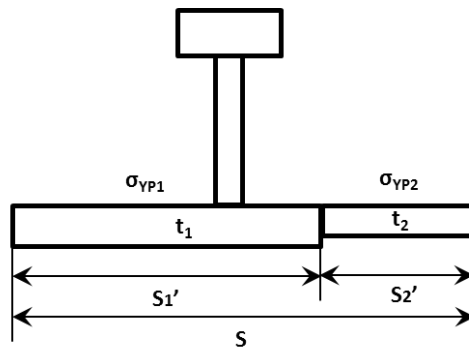

Fig. An3 Stiffener Element with Different Thickness and Yield Strength



An2.4 Derivation of Stress Acting on Stiffener Element

An2.4.1

The longitudinal stress σ_{xi} (N/mm²) and the transverse stress σ_{yi} (N/mm²) which are generated at the bottom shell of the position of stiffener element i are to be calculated according to the requirements of **Chapter 8** under the condition specified in **Table An2**.

An2.5 Calculation of Ultimate Strength of Stiffener Element

An2.5.1

The ultimate strength of stiffener element i , σ_{USi} (N/mm²) is to be as follows, but is not to be less than 0.

$$\sigma_{USi} = \min(\sigma_{US1i}, \sigma_{US2i}, \sigma_{US3i}) - \sigma_{x0i} \text{ for bulb, angle and T profiles}$$

$$\sigma_{USi} = \min(\sigma_{US1i}, \sigma_{US2i}, \sigma_{US4i}) - \sigma_{x0i} \text{ for flat bars}$$

σ_{x0i} : Longitudinal stress (N/mm²) acting on stiffener element i due to lateral loads, to be taken as follows:

$$\sigma_{x0i} = \sigma_{xi} - \sigma_{HG}$$

σ_{xi} : Longitudinal stress (N/mm²), as specified in **An2.4.1** above

σ_{HG} : Hull girder bending stress (N/mm²), to be taken as follows:

$$\sigma_{HG} = \frac{M_{S \max} + M_{W-Hog-Mid}}{Z_B} 10^{-3}$$

$M_{S\max}$: Permissible maximum vertical still water bending moment in seagoing condition ($kN\cdot m$) at the transverse section under consideration

$M_{W-Hog-Mid}$: As specified in 4.2.2.3.

σ_{US1i} , σ_{US2i} , σ_{US3i} , σ_{US4i} : Ultimate strength of stiffener element i (N/mm^2) for each critical failure mode, to be taken as following An2.5.2 to An2.5.5. All the symbols given in the following An2.5.2 to An2.5.5 pertain to stiffener element i .

An2.5.2

Ultimate strength of beam column buckling σ_{US1i} (N/mm^2), to be taken as follows:

$$\sigma_{US1i} = \sigma_{C1} \frac{A_{PE} + A_S}{A_P + A_S}$$

σ_{C1} : Critical stress (N/mm^2), equal to the following:

$$\sigma_{C1} = \sigma_{E1} \text{ for } \sigma_{E1} \leq \frac{\sigma_{YB}}{2}$$

$$\sigma_{C1} = \sigma_{YB} \left(1 - \frac{\sigma_{YB}}{4\sigma_{E1}}\right) \text{ for } \sigma_{E1} > \frac{\sigma_{YB}}{2}$$

σ_{YB} : Equivalent minimum yield stress (N/mm^2), to be taken as follows:

$$\sigma_{YB} = \frac{\sigma_{YP}A_{PE1}h_{PE} + \sigma_{YS}A_S h_{SE}}{A_{PE1}h_{PE} + A_S h_{SE}}$$

h_{PE} : Distance (mm) measured from the neutral axis of the stiffener with attached plate of width b_{E1} to the bottom of the attached plating.

h_{SE} : Distance (mm) measured from the neutral axis of the stiffener with attached plating of width b_{E1} to the top of the stiffener.

A_{PE1} : Area (cm^2) of attached plating, equal to the following:

$$A_{PE1} = b_{E1}t \times 10^{-2}$$

b_{E1} : Corrected effective width (mm) of the attached plating, equal to the following:

$$b_{E1} = \frac{s}{\beta_E} \text{ for } \beta_E > 1.0$$

$$b_{E1} = s \text{ for } \beta_E \leq 1.0$$

β_E : Coefficient, given as follows:

$$\beta_E = \sqrt{\frac{k\pi^2}{12(1-\nu^2)}} \cdot \sqrt{\frac{\sigma_{YP}}{\sigma_E}}$$

k : Coefficient, given as follows:

$$k = \left(\frac{m_0 s}{l} + \frac{l}{m_0 s}\right)^2$$

m_0 : Integer which satisfies the following formula $\sqrt{m_0(m_0 - 1)} < \frac{l}{s} \leq \sqrt{m_0(m_0 + 1)}$, but is not to be less than 0.

σ_E : Elastic buckling stress of attached plating (N/mm^2), equal to the following:

$$\sigma_E = \frac{Ek'\pi^2}{12(1-\nu^2)} \left(\frac{t}{s}\right)^2 - \left(\frac{l}{ms}\right)^2 \sigma_{yi}$$

m : Coefficient, given as follows:

$$m = m_0 \text{ for } \sigma_{yi} \leq \sigma_{ycm} \text{ or } m_0 \leq 2$$

$$m = m_0 - 1 \text{ for } \sigma_{yi} > \sigma_{ycm}$$

$$\sigma_{ycm} = \frac{E\pi^2}{12(1-\nu^2)} \left(\frac{t}{10^3 s}\right)^2 \left[1 - m_0^2(m_0 - 1)^2 \left(\frac{s}{\ell}\right)^4\right]$$

k' : Coefficient, given as follows:

$$k' = \left(\frac{ms}{l} + \frac{l}{ms}\right)^2$$

σ_{yi} : Transverse stress (N/mm^2) specified in An2.4.1 above.

σ_{E1} : Euler column buckling stress (N/mm^2), equal to the following:

$$\sigma_{E1} = \pi^2 E \frac{I_E}{A_E l^2} 10^2$$

I_E : Moment of inertia of stiffener (cm^4) with attached plating of width b_{E1} (m).

A_E : Area (cm^2) of stiffeners with attached plating width b_E

b_E : Effective width (mm) of attached plating, equal to the following:

$$b_E = \left(\frac{2.25}{\beta_E} - \frac{1.25}{\beta_E^2} \right) S \text{ for } \beta_E > 1.25$$

$$b_E = S \text{ for } \beta_E \leq 1.25$$

A_{PE} : Area (cm^2) of attached plating width b_E equal to the following:

$$A_{PE} = b_E t \times 10^{-2}$$

An2.5.3

Ultimate strength of torsional buckling σ_{US2i} (N/mm^2), to be taken as follows:

$$\sigma_{US2i} = \frac{A_P \sigma_{CP} + A_S \sigma_{C2}}{A_P + A_S}$$

σ_{C2} : Critical stress (N/mm^2), equal to the following:

$$\sigma_{C2} = \sigma_{E2} \text{ for } \sigma_{E2} \leq \frac{\sigma_{YS}}{2},$$

$$\sigma_{C2} = \sigma_{YS} \left(1 - \frac{\sigma_{YS}}{4\sigma_{E2}} \right) \text{ for } \sigma_{E2} > \frac{\sigma_{YS}}{2}$$

σ_{E2} : Euler torsional buckling stress (N/mm^2), taken as σ_{ET} specified in [An2.4.4.4, Annex 5.3 “Buckling Strength Assessment Relating to Longitudinal Strength \(UR S11A\)”](#).

σ_{CP} : Buckling stress of the attached plating (N/mm^2), equal to the following:

$$\sigma_{CP} = \left(\frac{2.25}{\beta_E} - \frac{1.25}{\beta_E^2} \right) \sigma_{YP} \text{ for } \beta_E > 1.25$$

$$\sigma_{CP} = \sigma_{YP} \text{ for } \beta_E \leq 1.25$$

β_E : As defined in [An2.5.2](#) above.

An2.5.4

Ultimate strength of web local buckling of flanged stiffeners σ_{US3i} (N/mm^2), to be taken as follows:

$$\sigma_{US3i} = \frac{b_E t \sigma_{YP} + (h_{we} t_w + b_f t_f) \sigma_{YS}}{st + h_w t_w + b_f t_f}$$

b_E : As defined in [An2.5.2](#).

h_{we} : Effective height of the web (mm), equal to the following:

$$h_{we} = \left(\frac{2.25}{\beta_w} - \frac{1.25}{\beta_w^2} \right) h_w \text{ for } \beta_w > 1.25$$

$$h_{we} = h_w \text{ for } \beta_w \leq 1.25$$

β_w : Coefficient, given as follows:

$$\beta_w = \frac{h_w}{t_w} \sqrt{\frac{\sigma_{YS}}{E}}$$

An2.5.5

Ultimate strength of web local buckling of flat bar stiffeners σ_{US4i} (N/mm^2), to be taken as follows:

$$\sigma_{US4i} = \frac{A_P \sigma_{CP} + A_S \sigma_{C4}}{A_P + A_S}$$

σ_{CP} : As defined in [An2.5.3](#) above.

σ_{C4} : Critical stress (N/mm^2), equal to the following:

$$\sigma_{C4} = \sigma_{E4} \text{ for } \sigma_{E4} \leq \frac{\sigma_{YS}}{2}$$

$$\sigma_{C4} = \sigma_{YS} \left(1 - \frac{\sigma_{YS}}{4\sigma_{E4}} \right) \text{ for } \sigma_{E4} > \frac{\sigma_{YS}}{2}$$

σ_{E4} : Local Euler buckling stress (N/mm^2), equal to the following:

$$\sigma_{E4} = 160000 \left(\frac{t_w}{h_w} \right)^2$$

An2.6 Calculation of Hull Girder Ultimate Strength

An2.6.1

Hull girder ultimate strength considering the effect of lateral loads $M_{U,DB}$ (kN-m) is to be taken as follows:

$$M_{U,DB} = \alpha_U \sigma_{US,avg} Z_B 10^3$$

$\sigma_{US,avg}$: Average of ultimate strength (N/mm^2) of all stiffener elements, to be taken as follows:

$$\sigma_{US,avg} = \frac{\sum_{i=1} (\sigma_{USi} A_i)}{\sum_{i=1} A_i}$$

σ_{USi} : As specified in **An2.5.1** above.

A_i : Area (cm^2) of stiffener element i to be taken as follows:

$$A_i = A_P + A_S$$

α_U : Correction factor, to be taken as follows:

$$\alpha_U = 1.25$$

Chapter 7 STRENGTH OF PRIMARY SUPPORTING STRUCTURES

7.1 General

7.1.1 Application

7.1.1.1

1 The requirements of this Chapter apply to ships of less than 150 m in length L_C .

2 Notwithstanding -1 above, strength assessments for deck girders with respect to deck loads and green sea loads are to be carried out in accordance with this Chapter.

3 For the double bottom and double-side skin structure, the requirements of the double hull structure specified in 7.3, Part 1 are to be applied. For other girder members that can be regarded as simple girders, the requirement of the simple girder specified in 7.2, Part 1 are to be applied.

7.1.1.2 Application Example of Assessment Model

1 An application example of assessment model applying 7.2 and 7.3, Part 1 is shown in Fig. 7.1.1-1.

2 For girder members that have a structure not shown in Fig. 7.1.1-1 and can be regarded as a simple girder, the boundary conditions and acting load are to be considered, and the assessment model from Table 7.2.1-2, Part 1 is to be appropriately selected.

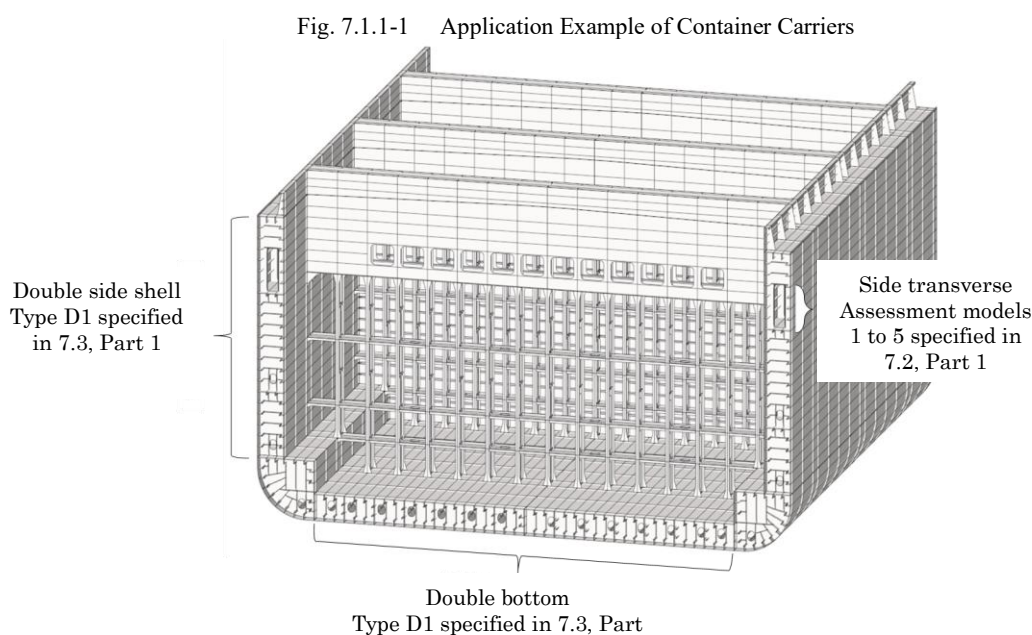

7.2 Double Hull Structure

7.2.1 General

7.2.1.1 Application

In applying 7.3, Part 1, when there are partial bulkheads in the middle of the hold, the range in the cargo hold under assessment is to be from the partial bulkhead to the watertight bulkhead.

7.2.1.2 Idealisation of Structures

1 ℓ_{DB} is to be taken as the length of the double bottom in the cargo hold under assessment.

2 B_{DB} is to be taken as the breadth of the double bottom in the cargo hold under assessment as either the following (1) or (2); however, if the breadth of the double bottom changes, B_{DB} is to be taken as the maximum breadth of double bottom in the cargo hold under assessment. (See Fig. 7.2.1-1)

- (1) Where the cargo hold is not provided with steps, B_{DB} is to be taken as the distance between the connections of the inner bottom plating and longitudinal bulkheads.
- (2) Where the cargo hold is provided with steps, B_{DB} is to be taken as the distance between the steps.

Fig. 7.2.1-1 Double Bottom Breadth

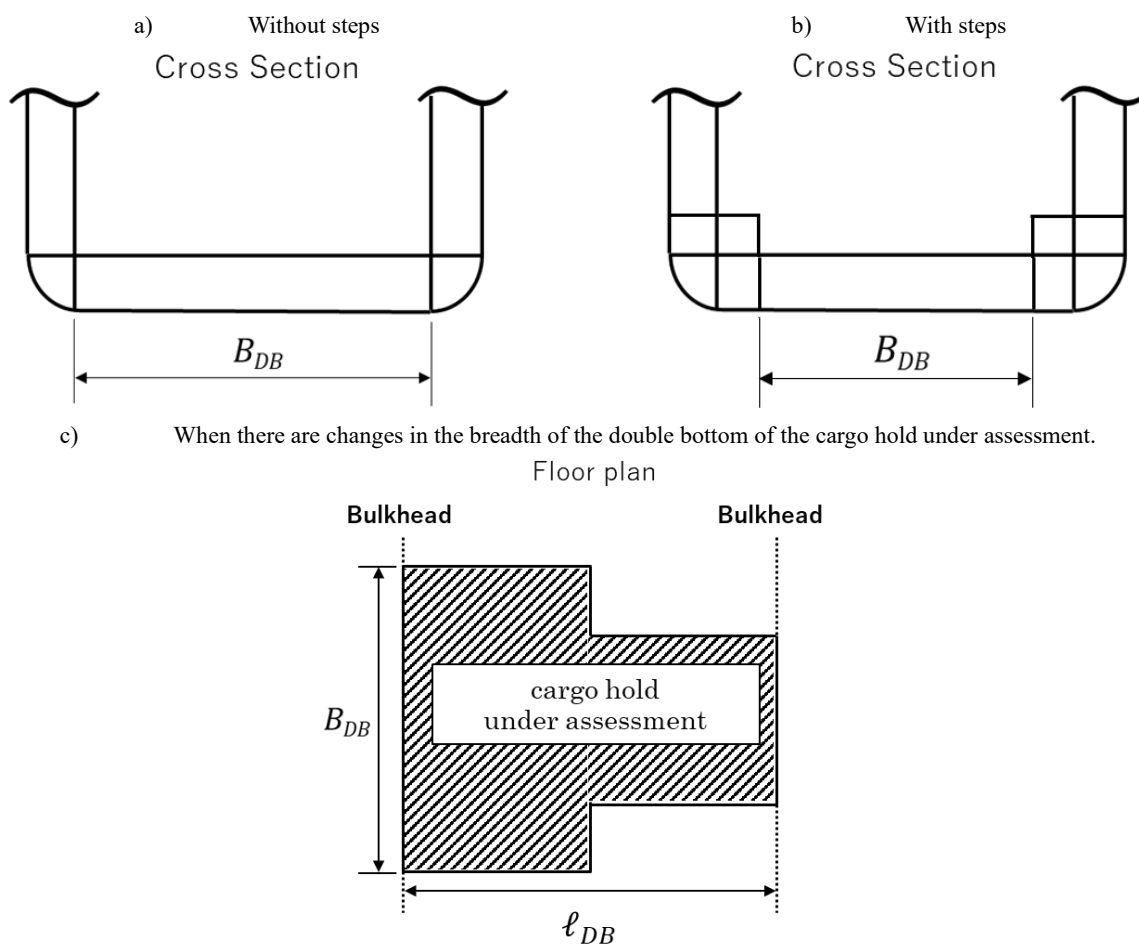

7.3 Deck Construction

7.3.1 Cross Deck

7.3.1.1

The scantlings of decks inside the line of deck openings in relation to bending in the deck plane are not to be less than those obtained from the following formulae. When calculating the section modulus and moment of inertia, the deck inside the line of deck openings is to be regarded as a web and the hatch end coaming as a flange. Where the construction is box-shaped or of similar construction, this requirement is to be applied.

- (1) Thickness t of deck plating (including the bottom plate in case of box-shaped construction)

$$t = 0.00417C_1K \left(\frac{l_v^2 l_c}{w_c} \right) \text{ (mm)}$$

Where:

K : As specified in [3.2.1.2, Part 1](#)

l_v : Distance (m) from the top of inner bottom plating to the bulkhead deck at the centre line of the ship

l_c : Width of hatchway (m)

Where two or more rows of hatchways are provided, the width of the widest hatchway is to be taken.

w_c : Width (m) of deck inside the line of deck openings

C_1 : As obtained from **Table 7.3.1-1** in accordance with the value of α . For intermediate values of α , the values of C_1 are to be determined by linear interpolation.

α : As obtained from the following formula:

$$\alpha = 0.5l_c \sqrt[4]{\frac{3 I_v}{4Sl_v^3 I_c}}$$

S : Spacing (m) of vertical webs provided on transverse bulkheads

I_v : Moment of inertia (cm⁴) of vertical webs provided on transverse bulkheads

I_c : Moment of inertia (cm⁴) of decks inside the line of deck openings

(2) Section modulus Z

$$Z = 1.19C_2 K l_v^2 l_c^2 \text{ (cm}^3\text{)}$$

Where:

C_2 : As obtained from **Table 7.3.1-1** in accordance with the value of α . For intermediate values of α , the values of C_2 are to be determined by linear interpolation.

α , l_v and l_c : As specified in (1)

(3) Moment of inertia

$$I = 0.317 \frac{l_c^4}{Sl_v^3} I_v \text{ (cm}^4\text{)}$$

Where:

S , l_c , l_v and I_v : As specified in (1)

Table 7.3.1-1 Coefficients C_1 and C_2

α	0.50 and under	1.50 and above
C_1	1.00	0.37
C_2	0.50	0.10

Chapter 8 STRENGTH ASSESSMENT BY CARGO HOLD ANALYSIS

8.1 General

8.1.1 Overview

8.1.1.1 Structure and Overview of this Chapter

- 1 This Chapter specifies a method for strength assessment by way of a cargo hold analysis on a container carrier.
- 2 The structure and overview of this Chapter are shown in [Table 8.1.1-1](#).

Table 8.1.1-1 Overview of Chapter 8

Section	Title	Overview
8.1	General	Additional requirements related to the overview and application of this Chapter
8.2	Evaluation Area and Members to be Assessed	Additional requirements related to the evaluation area and members to be assessed
8.3	Structural Models	Additional requirements related to extent of model, members to be modelled, meshing, etc.
8.4	Considerations for Corrosion	Additional requirements related to the net scantling approach
8.5	Boundary Conditions and Loads Conditions	Additional requirements related to the boundary conditions and loads conditions
8.6	Strength Assessment	Additional requirements for buckling strength assessment

8.1.2 Application

8.1.2.1 Applicable Ships

Ships that require strength assessment by cargo hold analysis is required, which fall under [8.1.2.1-1\(2\), Part 1](#) are to be ships of which the length of L_C is 150 m or more.

8.2 Evaluation Area and Members to be Assessed

8.2.1 Evaluation Area

8.2.1.1 Evaluation Area and Target Hold

For two-island design container carriers, when applying [8.2.1.1, Part 1](#), the fuel oil tank (deep oil tank) under a superstructure such as a bridge may be regarded as a target hold and strength assessment for the tanks may be required.

8.2.2 Members to be Assessed

8.2.2.1 Members to be Assessed for Maximum Load Condition, Harbour Condition and Testing Condition

In applying [8.2.2.1, Part 1](#), the structures and members to be assessed are to be as follows.

- (1) Double bottom structure (bottom shell, inner bottom plating, centre girder, side girder and floor)
- (2) Double side shell structure (side shell plating, longitudinal bulkhead, side stringer and side transverse)
- (3) Bulkhead structure (transverse bulkheads, partial bulkheads, and primary supporting members with said bulkheads)
- (4) Deck structure (strength deck, cross deck, hatch coaming, etc.)
- (5) Other members and locations deemed necessary by the Society

8.3 Structural Models

8.3.1 General

8.3.1.1 Extent of Model

1 In applying [8.3.1.1, Part 1](#), the model is, in principle, to represent three adjacent cargo holds with the target hold in the middle and the full depth and the full width of the holds are to be modelled.

2 Where strength assessment of a fuel oil tank (deep oil tank) on a two-island design container carrier are carried out, modelling the cargo holds (including the transverse bulkhead structure of the cargo hold) adjacent to the tank is taken as standard. If a superstructure such as a bridge is not modelled, the effect of the weight of the structure is to be considered by applying mass points to the model, etc.

8.3.2 Meshing

8.3.2.1 Hatch Coamings

In principle, the hatch coaming top plate is to be modelled with shell elements.

8.3.2.2 Openings

In principle, openings in the transverse girder in the bilge part are to be modelled by recreating the opening's shape or removing the appropriate elements in consideration of size and position of the opening.

8.4 Considerations for Corrosion

8.4.1 Net Scantling Approach

8.4.1.1

As for thickness of structural nodes and buckling strength assessment, the net scantling approach specified in [3.3, Part 1](#) is to be applied.

8.5 Boundary Conditions and Loads Conditions

8.5.1 Boundary Conditions

8.5.1.1

1 In applying [8.5.1, Part 1](#), the boundary conditions are to consist of the rigid links at model ends and point constraints in accordance with the requirements of [Table 8.5.1-1](#).

2 The independent point means the point located at the intersection of the neutral axis and the centre line in the cross section of both ends of the model. The dependent point means all the points of the element that are a model of the longitudinal members located in the cross section at both ends of the model. (See [Fig. 8.5.1-1](#))

Table 8.5.1-1 Boundary Conditions

Location and node		Translation direction			Rotation direction		
		X direction	Y direction	Z direction	Around the X axis	Around the Y axis	Around the Z axis
Aft end	Independent point	NA	Constraint	Constraint	Constraint	$-M_{V-end}$	$-M_{H-end}$
	Dependent point	Constraint by a rigid link					
Fore end	Independent point	Constraint	Constraint	Constraint	Constraint	$+M_{V-end}$	$+M_{V-end}$
	Dependent point	Constraint by a rigid link					
Notes:							
(1) NA means no constraint applied (i.e. free).							
(2) M_{V-end} , M_{H-end} : Adjustment vertical bending moment and adjustment horizontal bending moment, as given in 8.5.2.2 .							

Fig. 8.5.1-1 Independent Point

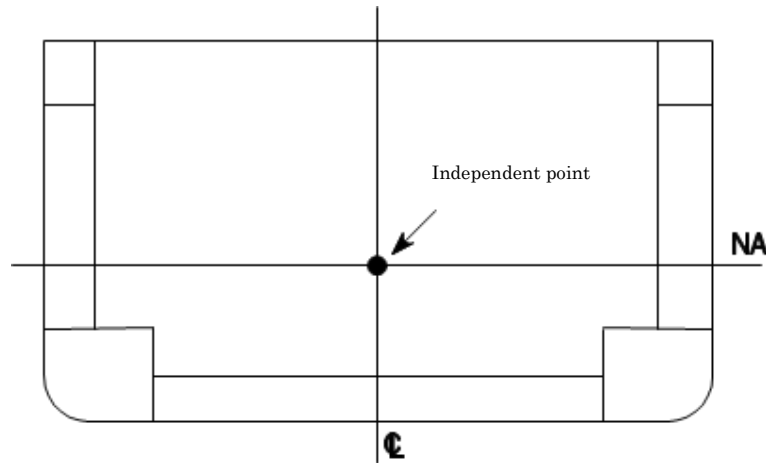

8.5.2 Load Conditions

8.5.2.1 Loads to Consider

In applying 8.5.2, Part 1, loads based also upon the additional requirements specified in 4.5 are to be considered.

8.5.2.2 Method of Applying Moments to the Structural Model

1 In applying 8.5.2.2-5, Part 1, the vertical bending moment and horizontal bending moment act on the target hold are to be adjusted, based on the boundary conditions specified in 8.5.1 and the value of the moment for each analysis case, in accordance with the following (1) to (3).

- (1) The maximum and minimum values of the vertical bending moment and horizontal bending moment act on the target hold due to the local loads are to be calculated by the following formulae. The local loads mean external pressure, internal pressure and weight of the hull structure, etc.

$$M_{V-Max} = \max(M_{V-FEM}(x_{btwn1}), M_{V-FEM}(x_{btwn2}))$$

$$M_{V-Min} = \min(M_{V-FEM}(x_{btwn1}), M_{V-FEM}(x_{btwn2}))$$

$$M_{H-Max} = \max(M_{H-FEM}(x_{btwn1}), M_{H-FEM}(x_{btwn2}))$$

$$M_{H-Min} = \min(M_{H-FEM}(x_{btwn1}), M_{H-FEM}(x_{btwn2}))$$

Here,

x_{btwn1} : The X coordinate position one quarter up from the length l_{hold} of the target hold from the rear end of the target hold (See Fig. 8.5.2-1).

x_{btwn2} : The X coordinate position three quarters up from the length l_{hold} of the target hold from the rear end of the target hold (See Fig. 8.5.2-1).

$M_{V-FEM}(x), M_{H-FEM}(x)$: Vertical bending moment ($kN-m$) due to local loads at any position x , to be taken as follows:

$$M_{V-FEM}(x) = -(x - x_{aft})R_{V-aft} - \sum_{i \atop x_i < x} (x - x_i)f_{vi}$$

$$M_{H-FEM}(x) = (x - x_{aft})R_{H-aft} + \sum_{i \atop x_i < x} (x - x_i)f_{hi}$$

x : X coordinate (m) of position x

x_{aft}, x_{fore} : X coordinate (m) of the aft and fore ends of the structural model

R_{V-fore}, R_{V-aft} : Vertical reaction forces (kN) at the support points at the fore and aft ends of the model, to be taken as follows:

$$R_{V-fore} = -\frac{\sum_i (x_i - x_{aft})f_{vi}}{x_{fore} - x_{aft}}$$

$$R_{V-aft} = -\sum_i f_{vi} - R_{V-fore}$$

R_{H-fore}, R_{H-aft} : Horizontal reaction forces (kN) at the support points at the fore and aft ends of the model, to be taken as follows:

$$R_{H-fore} = -\frac{\sum_i (x_i - x_{aft})f_{hi}}{x_{fore} - x_{aft}}$$

$$R_{H-aft} = - \sum_i f_{hi} - R_{H-fore}$$

f_{vi} , f_{hi} : Vertical and horizontal components of the local load in the length direction of the ship x_i (kN)

x_i : X coordinate (m) of the considered longitudinal station x_i .

- (2) The adjustment vertical bending moment M_{V-end} , and adjustment horizontal bending moment M_{H-end} (kN-m) are given by the following formulae.

$$M_{V-end} = M_{V-targ} - M_{V-min} \text{ for } M_{V-targ} \geq 0$$

$$M_{V-end} = M_{V-targ} - M_{V-max} \text{ for } M_{V-targ} < 0$$

$$M_{H-end} = M_{H-targ} - M_{H-min} \text{ for } M_{H-targ} \geq 0$$

$$M_{H-end} = M_{H-targ} - M_{H-max} \text{ for } M_{H-targ} < 0$$

M_{V-targ} , M_{H-targ} : The maximum or minimum value in the target hold for the vertical bending moment and horizontal bending moment (kN-m) specified in **Table 8.5.2-1**

- (3) The adjustment moments M_{V-end} , M_{V-end} and M_{H-end} obtained from (2) above are to be applied to the independent points at the fore and aft ends of the model.

Table 8.5.2-1 M_{V-targ} and M_{H-targ}

	Maximum load condition	Harbour condition	Testing condition	Flooded condition
Vertical bending moment M_{V-targ}	M_{V-HG}	M_{PT_max}	0	M_{FD_max} or M_{FD_min}
Horizontal bending moment M_{H-targ}	M_{H-HG}	0	0	0
Notes:				
M_{V-HG} , M_{H-HG} : The vertical bending moment and horizontal bending moment (kN-m) to be considered in maximum load condition specified in Chapter 4 .				
M_{PT_max} , M_{PT_min} : The vertical bending moment (kN-m) to be considered in harbour condition specified in Chapter 4 .				
M_{FD_max} , M_{FD_min} : The vertical bending moment (kN-m) to be considered in flooded condition specified in Chapter 4 .				

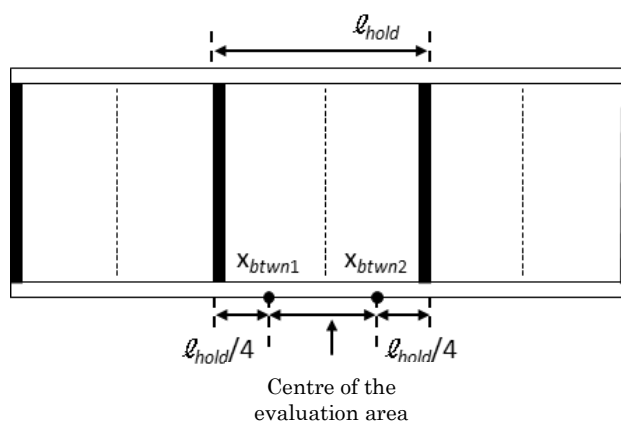
Fig. 8.5.2-1 Definitions of x_{btwn1} and x_{btwn2} in the Target Hold

2 Where the foremost cargo hold or the aftmost cargo hold is selected as a target hold, the relevant requirements in [8.4, Part 2-8](#) may be used as the method for adjustment of moment and boundary conditions.

8.6 Strength Assessment

8.6.1 Yield Strength Assessment and Buckling Strength Assessment

8.6.1.1 Buckling Strength Assessment of Girders Attached to Partial Bulkheads

1 In the buckling strength assessment of the girders attached to the partial bulkheads, the buckling strength of a plate panel or an opening panel is to be assessed as well as the buckling strength of the struts in [An2.5, Annex 8.6, Chapter 8, Part 1](#) (See [Table 8.6.1-1](#)). Where the buckling strength assessment of the struts is carried out, the struts may be taken as the members without openings.

2 In applying the requirements of -1 above, the following (1) and (2) are to be followed.

- (1) For the plate panel adjacent to the inner bottom plating and longitudinal bulkheads, the boundary conditions of [An2.5.1-2\(1\)\(ii\), Annex 8.6, Part 1 “Buckling Strength Assessment based on Cargo Hold Analysis”](#) are to be used.
- (2) For other plate panels, the boundary conditions of [An2.5.1-2\(1\)\(iii\), Annex 8.6, Part 1](#) are to be used.

3 Notwithstanding the requirements in -1 above, where the primary supporting members attached to the partial bulkheads are sandwiched between plate members on both sides, the boundary conditions of [An2.5.1-2\(1\)\(i\), Annex 8.6, Part 1](#) are to be used where deemed appropriate by the Society.

8.6.1.2 Strength Assessment of Side Shell in Beam Sea

1 When a strength assessment is performed considering the load based on the equivalent design waves BR and BP in maximum load condition, [8.6.2.1-2, Part 1](#) may be applied for stiffened panels of side shell instead of [8.6.2.1-1, Part 1](#) where the stress in the direction parallel to the shorter edge of the panels, which is due to bending deformation of side transverse and side shell, is dominant component (See [Table 8.6.1-1](#)).

2 In application of -1 above, yield strength assessment specified in [8.6.1, Part 1](#) of side shell need not be carried out.

3 In application of -1 above, where the yield strength assessment and buckling strength assessment specified in [An2.7, Annex 8.6A, Part 1 “Strength Assessment Considering Effect of Surrounding Structures”](#) are carried out, the yield strength and buckling strength assessments need not be required for the following (1) to (3).

- (1) Stiffened panels within the rigidity reduction range
- (2) Buckling panels which include elements sharing nodes included in the elements of (1) above
- (3) Elements which include (1) and (2) above

Table 8.6.1-1 Relationship between the Application of Part 1 and Part 2

Member to be assessed	Maximum load condition	
	Equivalent design waves <i>HM</i> and <i>FM</i>	Equivalent design waves <i>BR</i> and <i>BP</i>
Side shell (Annex 8.6A, Part 1 is applied for equivalent design waves <i>BR</i> and <i>BP</i>)	<ul style="list-style-type: none"> • Yield strength assessment: As specified in 8.6.1, Part 1 • Buckling strength assessment: As specified in 8.6.2.1-1, Part 1 	<ul style="list-style-type: none"> • An2.2 to An2.6 of Annex 8.6A, Part 1 are applied. • Permissible utilization factor (buckling): 0.8 • Yield strength assessment: <i>NA</i>
Members other than side shell (Annex 8.6A, Part 1 is applied for equivalent design waves <i>BR</i> and <i>BP</i>)		<ul style="list-style-type: none"> • An2.7 of Annex 8.6A, Part 1 is applied. • Yield strength assessment: As specified in 8.6.1, Part 1. • Buckling strength assessment: As specified in 8.6.2.1-1, Part 1.
Girders attached to partial bulkhead ⁽¹⁾	<ul style="list-style-type: none"> • Yield strength assessment: As specified in 8.6.1, Part 1. • Buckling strength assessment: As specified in 8.6.2.1-1, Part 1. In addition, as specified in 8.6.1.1. 	
Notes:		
(1) The same requirements apply to harbour condition, testing condition and flooded condition.		

8.6.1.3 Strength Assessments of Transverse Bulkheads in Flooded Condition

Where strength assessments are performed in the flooded condition, girders attached to transverse bulkheads are to satisfy the criteria for yield strength assessment and buckling strength assessment. Platings of bulkheads, however, only need to satisfy the criteria for yield strength assessment.

Chapter 9 FATIGUE

Symbols

C_{cor} : Coefficient that corrects the stress obtained from the gross scantling approach to the net scantling approach.
e.g. 1.0 when the net scantling approach is used, 1.025 when the gross scantling approach is used.

9.1 General

9.1.1 General

9.1.1.1 Overview

1 Unless otherwise specified, the fatigue strength assessment method of longitudinal end connections by simplified stress analysis, and the torsional fatigue strength assessment method of connections of plate and girder, and the free edge of base material by finite element stress analysis for container carriers are to be according to this Chapter instead of **Chapter 9, Part 1**.

2 In principle, for container carriers, the fatigue strength assessment by finite element analysis using the three-hold model specified in **9.4, Part 1** is not to be carried out but the fatigue strength assessment by finite element analysis based on hull girder load using the full ship model specified in this Chapter is to be carried out.

9.1.1.2 Application

1 Ships with a length L_C of 150 m or more are to be assessed for fatigue strength based on **9.5, Part 1** at the midship part of cargo region using hot spot stress of longitudinal penetration at the girder or bulkhead section obtained by the simplified stress analysis specified in **9.3, Part 1**. In this case, the loads used in the assessment are to be in accordance with the requirement in **4.6.4**. The fatigue strength other than those at the midship part of cargo region is to be carried out where deemed necessary by the Society.

2 For ships to which (1) or (2) are applicable, in addition to the requirements of -1 above, the fatigue strength assessment based on **9.5, Part 1** is to be carried out using hot spot stress of connections of the plate and girder, and the free edge of the base material obtained from the finite element analysis specified in this chapter.

- (1) Ships not less than 200 m in length L_C ;
- (2) Ships exceeding 32.26 m in breadth B .

9.1.2 Assumptions

9.1.2.1 Assumptions

The following assumptions (1) to (9) are made in the fatigue strength assessment.

- (1) A linear cumulative damage model (i.e. Miner's rule) given in **9.5.4, Part 1** is used in the calculation of fatigue damage.
- (2) Fatigue design life T_{FD} is taken not less than 25 years.
- (3) Hull girder load for torsional strength assessment is determined at the 10^{-2} probability level of exceedance.
- (4) Stresses are assessed by the net scantlings t_{n25} , according to **9.4**.
- (5) Hot spot stress is used for fatigue strength assessment of weld toes and the free edge of members.
- (6) Excluding exceptional cases, fatigue strength assessment of welds is made for the weld toe. For the welded joints where loads are carried to the weld, the welded joints are to be in accordance with the detail design standards specified in **9.5** and **9.6, Part 1** or weld root fatigue strength is to be assessed in accordance with the requirement in **9.7, Part 1**.
- (7) The design $S-N$ curve at two standard deviation below the mean $S-N$ curve is used. The $S-N$ curve in the in-air environment is used for the period when the coating at the location being assessed is effective and the $S-N$ curve in the corrosive environment is used for the period when the effectiveness of the coating is lost.
- (8) The long-term distribution of the stress range for wave loads is assumed to follow an exponential distribution.
- (9) The acceptance criterion for fatigue strength assessment is given in **9.5.5, Part 1**.

9.2 Hot Spots to Assess

9.2.1 Hot Spots to be Assessed by Finite Element Analysis

9.2.1.1 Structural Details to be Assessed by Fatigue Strength Assessment

- 1 The hot spots to be assessed for fatigue strength by finite element analysis according to 9.4 are shown in Table 9.2.1-1.
- 2 The assessment is to be carried out throughout the length of ship.

Table 9.2.1-1 Structural Details of Primary Members to be Assessed in the Hull Structure

No.	Critical structural details of hull structure
1	Hatch corner at the height of the hatch side coaming top plating
2	Intersections between the upper deck and transverse bulkhead (the line on the hatchway side)
3	Intersections between the second deck and transverse bulkhead (the line on the hatchway side)
4	Intersections between top plating of steps in cargo hold and the inner longitudinal bulkhead
5	Arrest hole (when arrest design is provided with arrest hole)
6	Other areas with large stress concentration

9.3 Fatigue Strength Assessment of Longitudinal End Connections

9.3.1 General

9.3.1.1

The end geometries of web stiffeners in way of the end connections of side longitudinals installed between $0.82T_{sc}$ and T_{sc} are to be maintained as that of the side longitudinal just below $0.82T_{sc}$.

9.3.2 Loading Conditions and Fractions of Time to be Considered

9.3.2.1

- 1 Standard loading conditions and fractions of time are to be as given in Table 9.3.2-1.
- 2 Notwithstanding -1 above, an appropriate combination is to be considered in cases where considering loading conditions and fractions of time other than those given in Table 9.3.2-1.

Table 9.3.2-1 Standard Loading Conditions and Fractions of Time

Loading condition	Fraction of time $\alpha_{(j)}$
Container cargo homogeneously loaded condition 1 (Ballast tank fully loaded condition)	50 %
Container cargo homogeneously loaded condition 2 (Ballast tank empty condition)	50 %

9.3.3 Simplified Assessment of the Effect of Relative Displacement at Ends of Transverse Bulkheads

9.3.3.1

1 Instead of directly considering the stress due to relative displacement specified in 9.3.5, Part 1, multiplying fatigue damage calculated not considering the stress due to relative displacement by three may be allowed. However, in the case of side longitudinals, it is assumed that soft-shaped backing brackets are fitted.

2 If the requirement specified in -1 above is not followed, the effect of stress due to relative displacement specified in 9.3.5, Part 1 is to be considered using finite element analysis.

9.4 Torsional Fatigue Strength Assessment

9.4.1 General

9.4.1.1 General

The requirements of the evaluation method for hot spot stresses of plate and girder joints and the free edge of base materials by very fine finite element analysis of torsional fatigue strength assessment is specified in 9.4. The hot spot stress takes into account structural discontinuities due to the structural details of joints but does not consider local stress concentrations due to the presence of welds.

9.4.1.2 Confirmation of Calculation Method and Accuracy of Analysis

The analysis method and analysis program are to be in accordance with the requirement in 9.4.1.2, Part 1.

9.4.1.3 Strength Assessment Based on Advanced Analysis

In the application of 9.4, the strength assessment based on an advanced analysis, such as direct load analysis, may be conducted when deemed appropriate by the Society. However, when the hot spot stress is calculated from the stress obtained by the analysis, no other methods than those specified in 9.4 are to be adopted.

9.4.1.4 Types of Hot Spot Stress

The types of hot spot stress are according to 9.4.1.4, Part 1.

9.4.1.5 Evaluation Procedure

The procedures for the fatigue strength assessment are to be in accordance with the following (1) to (4): (See Fig. 9.4.1-1)

- (1) Carry out the whole ship FE analysis applying vertical still water bending moment, and then calculate the hot spot mean stress at the locations to be assessed.
- (2) Carry out the whole ship FE analysis applying vertical wave bending moment, horizontal wave bending moment, and wave torsional moment, and then calculate the hot spot stress range of the locations to be assessed.
- (3) Calculate the cumulative fatigue damage by applying the long-term distribution of the hot spot stress range to the $S-N$ curve. At this time, the period of exposure to the corrosive environment is to be considered.
- (4) Check that the fatigue damage does not exceed the permissible standard.

Fig. 9.4.1-1 Evaluation Procedure

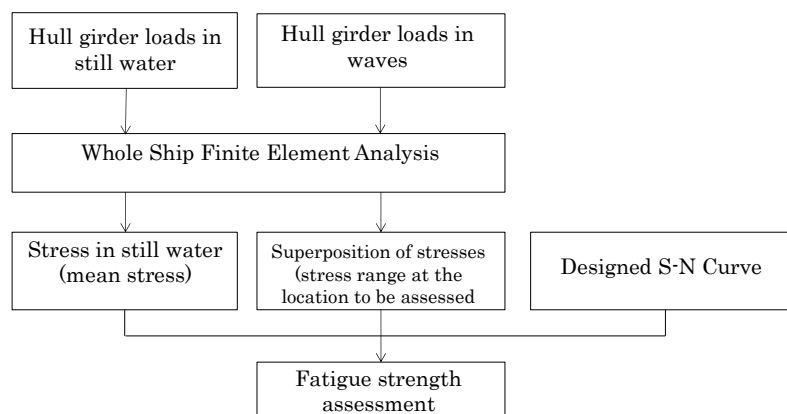

9.4.2 Finite Element Method

9.4.2.1 General

1 The standard method for evaluation of hot spot stresses for fatigue strength assessment is to incorporate very fine finite element mesh zones for areas specified in Table 9.2.1-1 into the global model.

2 Alternatively, in cases where very fine mesh analysis is carried out by means of separate local finite element models with very fine mesh zones in conjunction with the boundary conditions obtained from a global model of the cargo holds, the analysis method is to be approved in advance by the Society.

9.4.2.2 Extent of Model

The extent of a model is the full length, the full depth, and the full width. The structural member is to be modelled.

9.4.2.3 Members to be Modelled, Element Types, Mesh Size, and Notes on Modelling

Members to be modelled, element types, mesh size, and notes on modelling are shown in [9.4.2.3, Part 1](#), [9.4.2.4, Part 1](#), [9.4.2.7, Part 1](#) and [9.4.2.8, Part 1](#), respectively.

9.4.2.4 Corrosion Model

1 The very fine mesh finite element models used for torsional fatigue strength assessment are to be made using t_{n25} (mm) in accordance with the corrosion addition specified in [3.3.4 in Part 1](#).

2 Notwithstanding the requirement in -1 above, where deemed appropriate by the Society, assessment using the gross scantling approach may be applied.

9.4.3 Modelling Procedure

9.4.3.1 Modelling Procedure

The modelling procedure is to be in accordance with the requirement in [9.4.3, Part 1](#).

9.4.4 Boundary Conditions and Load Conditions

9.4.4.1 Boundary Conditions

1 Boundary conditions are to be set to appropriately reproduce the structural responses of the whole ship model in consideration of the extent of model and loads to be considered, etc.

2 Boundary conditions which do not generate torsional deformation are to be given when calculating stress due to horizontal bending moments.

3 The boundary conditions for torsional moment is to constrain the translational and rotational displacements of the positions where the reaction force in the port and starboard model is thought to be small.

4 The standard boundary conditions are in accordance with the following (1) to (3):

- (1) The boundary conditions for the standard torsional moment are as shown in [Fig. 9.4.4-1](#).
- (2) The boundary conditions for the standard vertical bending moment are as shown in [Fig. 9.4.4-2](#).
- (3) The boundary conditions for the standard horizontal bending moment are as shown in [Fig. 9.4.4-3](#).

Fig. 9.4.4-1 Boundary Conditions of Torsional Moment

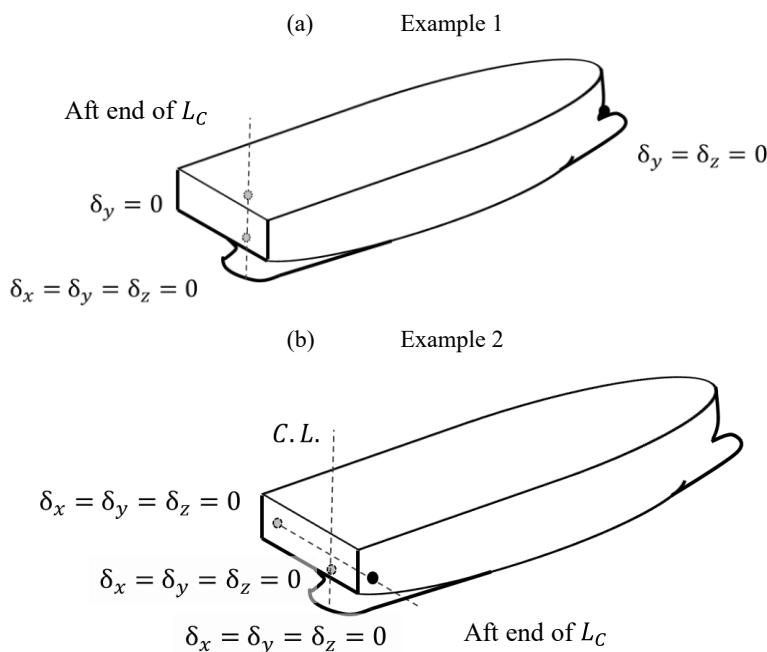

Fig. 9.4.4-2 Boundary Conditions of Vertical Bending Moments and Load Conditions

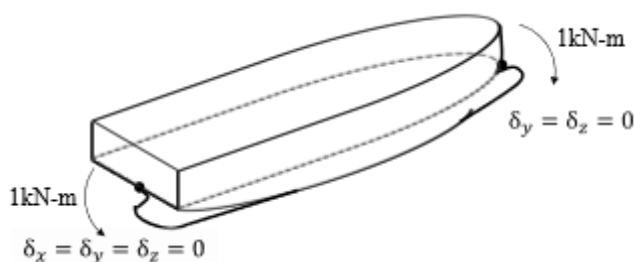
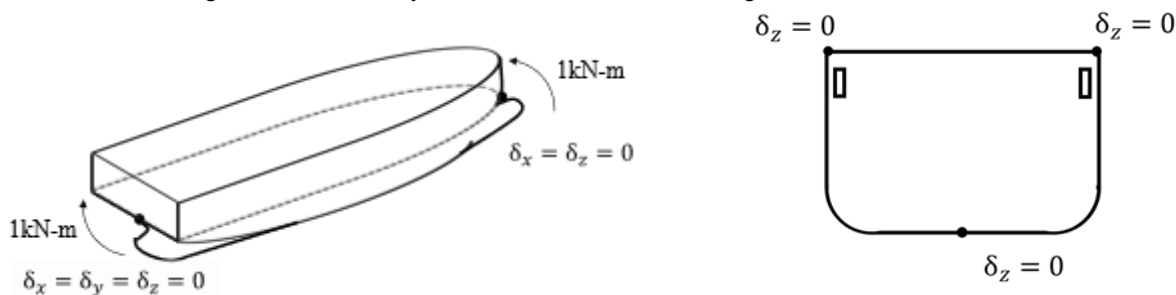

Fig. 9.4.4-3 Boundary Conditions of Horizontal Bending Moments and Load Conditions



* apply to each transverse bulkhead

9.4.4.2 Load Conditions

- 1 The loads to be used in torsional fatigue strength assessments are to be in accordance with 4.6.3.
- 2 Stresses due to vertical bending moments, horizontal bending moments and torsional moments are calculated based on structural analysis using the whole ship model.
- 3 Torsional moments are to be applied to structural models in accordance with the following (1) to (3):
 - (1) Torsional moments acting on hull girders are to be applied to structural models as a series of bulkhead torsional moments resulting in a stepped curve. An approximated torsional step moment curve is shown in Fig. 9.4.4-4.
 - (2) Torsional moments applied to bulkheads are the net change in torsional moment over the effective range of the bulkhead. The effective range of a bulkhead is the distance between the midpoints of the two adjacent bulkheads. The torsional moments at bulkhead i ($kN-m$) are specified as the following formulae: (See Fig. 9.4.4-5)

$$\delta M_{WT1i} = M_{WT1} \Big|_{\frac{1}{2}(X_i + X_{i+1})} - M_{WT1} \Big|_{\frac{1}{2}(X_{i-1} + X_i)}$$

$$\delta M_{WT2i} = M_{WT2} \Big|_{\frac{1}{2}(X_i + X_{i+1})} - M_{WT2} \Big|_{\frac{1}{2}(X_{i-1} + X_i)}$$

$$X_i: \text{ X-coordinate of bulkhead } i$$
 - (3) Torsional moments for bulkheads are to be reproduced by two equivalent shear forces on each side. An example of a method for applying shear force is shown in Fig. 9.4.4-6.
- 4 When analysing the vertical and horizontal bending moments applied, a method applying unit moments is to be used as the standard. Stresses corresponding to the moments prescribed in 4.6.3.2 are to be calculated based on the stresses obtained through structural analysis with unit moments applied. (See Fig.9.4.4-2 and Fig.9.4.4-3)

Fig. 9.4.4-4 Torsional Moments Acting on Hull Girders (Approximated Step Curve)

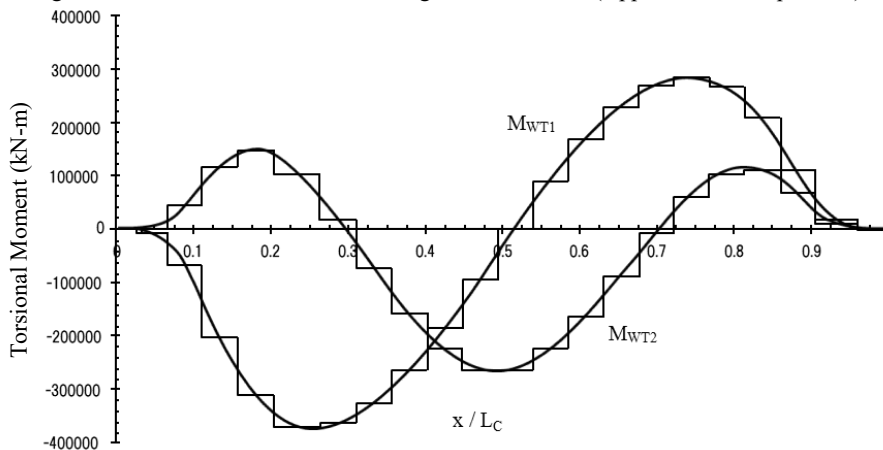

Fig. 9.4.4-5 Torsional Moment Applied to Bulkhead i

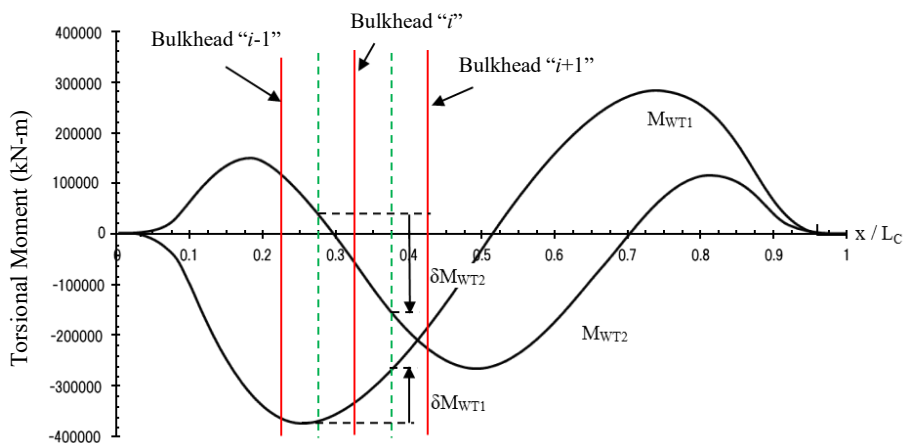
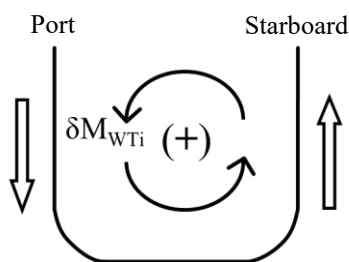

Fig. 9.4.4-6 Torsional Moment Reproduction Due to Shear Force



9.4.5 Hot Spot Stresses

9.4.5.1 Resultant Stress Range and Mean Stress

- 1 The dominant stress for the initiation of fatigue cracks at weld toe is the stress in the direction orthogonal to weld line.
- 2 The resultant stress range in the direction orthogonal and parallel to the weld line is to be obtained based on the stresses obtained by the finite element analysis specified in 9.4. The orthogonal direction to the weld line is represented by the x -direction and the parallel direction is represented by the y -direction.
- 3 The resultant stress range of type "a" hot spot $\Delta\sigma_{ort}$ (N/mm^2) or $\Delta\sigma_{par}$ (N/mm^2) and the mean stress of type "a" hot spot σ_{ort_mean} (N/mm^2) or σ_{par_mean} (N/mm^2) are to be obtained from the following formula.

$$\Delta\sigma_{ort} = \sqrt{\Delta\sigma_x^2 + \Delta\tau_{xy}^2}$$

$$\Delta\sigma_{par} = 0.72 \sqrt{\Delta\sigma_y^2 + \Delta\tau_{xy}^2}$$

$$\sigma_{ort_mean} = \begin{cases} \operatorname{sgn}(\bar{\sigma}_x) \sqrt{\bar{\sigma}_x^2 + \bar{\tau}_{xy}^2} & : |\bar{\sigma}_x| \geq |\bar{\tau}_{xy}| \\ \operatorname{sgn}(\bar{\tau}_{xy}) \sqrt{\bar{\sigma}_x^2 + \bar{\tau}_{xy}^2} & : |\bar{\sigma}_x| < |\bar{\tau}_{xy}| \end{cases}$$

$$\sigma_{par_mean} = \begin{cases} \operatorname{sgn}(\bar{\sigma}_y) 0.72 \sqrt{\bar{\sigma}_y^2 + \bar{\tau}_{xy}^2} & : |\bar{\sigma}_y| \geq |\bar{\tau}_{xy}| \\ \operatorname{sgn}(\bar{\tau}_{xy}) 0.72 \sqrt{\bar{\sigma}_y^2 + \bar{\tau}_{xy}^2} & : |\bar{\sigma}_y| < |\bar{\tau}_{xy}| \end{cases}$$

$\operatorname{sgn}(X)$: Positive and negative signs of stress X (positive when normal stress is tension and positive when shear stress is in CCW direction)

$\Delta\sigma_x$: Stress range (N/mm^2) in the x direction in the x - y coordinate system according to the following formula:

$$\Delta\sigma_x = C_{cor} \sqrt{(\sigma_{WV-h_x} - \sigma_{WV-s_x})^2 + 4(\sigma_{WH1_x} + \sigma_{WT1_x})^2 + 4(\sigma_{WH2_x} + \sigma_{WT2_x})^2}$$

$\sigma_{WV-h_x}, \sigma_{WV-s_x}$: Hot spot stress in the x direction due to vertical wave bending moment M_{WV-h} and M_{WV-s}

$\sigma_{WH1_x}, \sigma_{WT1_x}$: Hot spot stress in the x direction due to horizontal wave bending moment M_{WH1} and M_{WH2}

$\sigma_{WH2_x}, \sigma_{WT2_x}$: Hot spot stress in the x direction due to torsional wave moment M_{WT1}, M_{WT2}

$\Delta\sigma_y$: Stress range (N/mm^2) in the y direction in the x - y coordinate system according to the following formula:

$$\Delta\sigma_y = C_{cor} \sqrt{(\sigma_{WV-h_y} - \sigma_{WV-s_y})^2 + 4(\sigma_{WH1_y} + \sigma_{WT1_y})^2 + 4(\sigma_{WH2_y} + \sigma_{WT2_y})^2}$$

$\sigma_{WV-h_y}, \sigma_{WV-s_y}$: Hot spot stress in the y direction due to vertical wave bending moment M_{WV-h} and M_{WV-s}

$\sigma_{WH1_y}, \sigma_{WT1_y}$: Hot spot stress in the y direction due to horizontal wave bending moment M_{WH1} and M_{WH2}

$\sigma_{WH2_y}, \sigma_{WT2_y}$: Hot spot stress in the y direction due to torsional wave moment M_{WT1}, M_{WT2}

$\Delta\tau_{xy}$: Stress range of shear stress in the x - y coordinate system (N/mm^2) according to the following formula:

$$\Delta\tau_{xy} = C_{cor} \sqrt{(\tau_{WV-h_{xy}} - \tau_{WV-s_{xy}})^2 + 4(\tau_{WH1_{xy}} + \tau_{WT1_{xy}})^2 + 4(\tau_{WH2_{xy}} + \tau_{WT2_{xy}})^2}$$

$\tau_{WV-h_{xy}}, \tau_{WV-s_{xy}}$: Hot spot stress (N/mm^2) of shear stress due to vertical wave bending moment M_{WV-h} and M_{WV-s}

$\tau_{WH1_{xy}}, \tau_{WT1_{xy}}$: Hot spot stress (N/mm^2) of shear stress due to horizontal wave bending moment M_{WH1} and M_{WH2}

$\tau_{WH2_{xy}}, \tau_{WT2_{xy}}$: Hot spot stress (N/mm^2) of shear stress due to torsional wave moment M_{WT1}, M_{WT2}

$\bar{\sigma}_x$: Mean stress (N/mm^2) in the x direction in the x - y coordinate system due to vertical still water bending moment

$\bar{\sigma}_y$: Mean stress (N/mm^2) in the y direction in the x - y coordinate system due to vertical still water bending moment

$\bar{\tau}_{xy}$: Mean stress (N/mm^2) of shear stress in the x - y coordinate system due to vertical still water bending moment

4 The resultant stress range of type “b” hot spot, or free edge of base material $\Delta\sigma_{ort}$ (N/mm^2) and the average stress of type “b” hot spot, or free edge of base material σ_{ort_mean} (N/mm^2) are to be obtained from the following formula.

$$\Delta\sigma_{ort} = |\Delta\sigma_a|$$

$$\sigma_{ort_mean} = \bar{\sigma}_a$$

$\Delta\sigma_a$: The stress range of axial stress (N/mm^2) according to the following formula:

$$\Delta\sigma_a = C_{cor} \sqrt{(\sigma_{WV-h_a} - \sigma_{WV-s_a})^2 + 4(\sigma_{WH1_a} + \sigma_{WT1_a})^2 + 4(\sigma_{WH2_a} + \sigma_{WT2_a})^2}$$

$\sigma_{WV-h_a}, \sigma_{WV-s_a}$: Hot spot stress (N/mm^2) in the axial direction due to vertical wave bending moment M_{WV-h} and M_{WV-s}

$\sigma_{WH1_a}, \sigma_{WT1_a}$: Hot spot stress (N/mm^2) in the axial direction due to horizontal wave bending moment M_{WH1} and M_{WH2}

$\sigma_{WH2_a}, \sigma_{WT2_a}$: Hot spot stress (N/mm^2) in the axial direction due to torsional wave moment M_{WT1}, M_{WT2}

$\bar{\sigma}_a$: Mean stress (N/mm^2) in the axial direction due to vertical still water bending moment

9.4.5.2 Hot Spot Locations and Stress Readout Points, Stress Readout Method and Hot Spot Stresses

The hot spot locations and stress readout points, stress readout method, and stress reference points and hot spot stresses are to be in accordance with **9.4.5.2, Part 1**, **9.4.5.3, Part 1** and **9.4.5.4, Part 1**, respectively.

9.4.5.3 Weld Root Fatigue Strength Assessment

Weld root fatigue strength assessment is to be in accordance with **9.7, Part 1**.

9.5 Detailed Design Standards**9.5.1 General****9.5.1.1 General**

1 Free edges, including hatch corners of hatch side coamings are to be in accordance with the following **(1)** to **(3)**:

- (1) Free from any defects such as notches that may adversely affect fatigue strength.
- (2) Appropriate edge treatment, including the treatment of corner edges, is to be carried out so that edges have sufficient fatigue strength.
- (3) Details of the edge treatment used are, in principle, to be clearly mentioned in relevant drawings.

2 In cases where equipment such as hatch cover pads and container pads is fitted, the fitting method is to be in accordance with the following **(1)** to **(3)**:

- (1) Consideration is to be given to equipment materials and welding procedures.
- (2) Fillet welded joints for attaching equipment are to be set at a sufficient distance from hatch corners so that the effects of stress concentration are avoided.
- (3) The Society may require fatigue strength assessments in consideration of the kind of steel used, the size of the ship, and the structural arrangement, etc.

3 Hatch side coaming ends, including fillet-welded parts to strength decks, are to be in accordance with the following **(1)** and **(2)**:

- (1) Fillet welds for hatch side coaming ends and strength decks are, in principle, to be full penetration welds within a certain range.
- (2) Boxing welds at the ends are to be smoothed out using a grinder or other means.

4 Butt welds for hatch side coamings are to be in accordance with the following **(1)** and **(2)**:

- (1) Set at a sufficient distance from hatch corners so that the effects of stress concentration are avoided.
- (2) The Society may require fatigue strength assessments in consideration of the kind of steel used, the size of the ship, and the structural arrangement, etc.

5 Special consideration is to be given to fatigue strength in way of drain holes and other holes installed in hatch side coamings.

Chapter 10 ADDITIONAL STRUCTURAL REQUIREMENTS

10.1 Bottom Structure

10.1.1 Double Bottoms

10.1.1.1 General

The inner bottom plating with which the lower ends of corner fittings of containers are in contact is to be strengthened by means of doubling or by other appropriate means.

10.2 Side Structure

10.2.1 Double Side Structure

10.2.1.1 General

Where the inner hull plating and the inner bottom plating are combined, considerations are to be made to their structural arrangement so as not to cause stress concentration.

10.3 Deck Structure

10.3.1 General

10.3.1.1 Continuity of Thickness

Consideration is to be made to the continuity in the thickness of deck plating and hatch coaming top plate, and to the avoidance of remarkable differences between the thicknesses of the cross-deck and other strength decks as well as the hatch coaming top plate above it.

10.4 Bulkhead Structure

10.4.1 Transverse Bulkheads

10.4.1.1 Construction

Transverse bulkheads are to be constructed so as to be sufficiently supported at the deck. Where the width of the bulkhead is especially large, the upper parts of transverse bulkheads are to be appropriately strengthened by providing box-shaped structures or by other means.

10.4.1.2 Partial Bulkheads

Where non-watertight partial bulkheads are provided in cargo holds, the construction and scantlings are to be considered so that it can effectively support the loads from the ship's sides and deck.

10.5 Special Requirements for Container Carriers Applying Extremely Thick Steel Plates

10.5.1 Special Requirements for Container Carriers Applying Extremely Thick Steel Plates

10.5.1.1 General

This 10.5 gives measures for identification and prevention of brittle fractures in container carriers to which extremely thick steel plates are applied for longitudinal structural members in the upper deck region (the upper deck plating, hatch side coaming (including top plating) and their attached longitudinals). These include measures to prevent brittle crack initiation and to arrest brittle crack propagation in case brittle crack initiates.

10.5.1.2 Application

1 This 10.5 is applied when using any of *KA36*, *KD36*, *KE36*, *KA40*, *KD40*, *KE40* and *KE47* steel plates having thickness of over 50 mm and not greater than 100 mm for longitudinal structural members in the upper deck regions of container carriers.

2 Notwithstanding the requirement given in this 10.5, when as-built thickness of the hatch side coaming (including top plating) is not greater than 50 mm, this section may not be necessarily applied regardless of the thickness and grade of steel of the strength deck.

3 The structural members of container carriers applying extremely thick steel plates are to comply with the requirements in Part 2-1 in addition to the requirements in 10.5.

10.5.1.3 Measures for Prevention of Brittle Fracture*

Measures for prevention of brittle fracture applying to extremely thick steel plates are to be utilized the combination shown in Table 10.5.1-1 according to the thickness and grade of steel of the hatch side coaming (including top plating).

Table 10.5.1-1 Application of Measures for Prevention of Brittle Fractures

Hatch side coaming (including top plating)		Non-destructive inspection during ship construction specified in 1.4.2-1 (3), Part M.	Brittle crack arrest design specified in 10.5.1.4
Grade of steel	Thickness (mm)		
KA36 KD36 KE36	50 < t ≤ 100	To be applied	Need not to be applied
KA40	50 < t ≤ 85		
KD40 KE40	85 < t ≤ 100	To be applied	To be applied ⁽¹⁾
KE47 (where electro-gas welding is applied at block-to-block butt joints)	50 < t ≤ 100	To be applied	To be applied
KE47 (where welding procedures other than electro-gas welding are applied at block-to-block butt joints)	50 < t ≤ 100	To be applied	To be applied ⁽¹⁾

Note:

Other measures deemed by the Society to be equivalent in effectiveness to brittle crack arrest designs may be accepted.

10.5.1.4 Brittle Crack Arrest Design*

1 The brittle crack arrest design using brittle crack arrest steels specified in 10.5 may be applied when HT36 or HT40 is used for the upper deck plating. In other cases, however, appropriate measures to prevent the initiation and propagation of brittle cracks deemed appropriate by the Society are to be applied.

2 Brittle crack arrest design is to be utilised to prevent large scale fractures of the hull girder by arresting propagation of the brittle crack at a proper position, even in case where brittle crack initiation occurs within the cargo hold region.

3 Following (1) and (2) are to be considered as the points of brittle crack initiation.

- (1) Block-to-block butt joints both of hatch side coaming and strength deck; and
- (2) Any welds other than (1) above.

4 Following (1) to (3) are to be considered as the cases of brittle crack propagation.

- (1) Cases where the brittle crack initiates from block-to-block butt joint and runs straight along the butt joint;
- (2) Cases where the brittle crack initiates from block-to-block butt joint and deviate away from butt joint and runs into base metal; and
- (3) Cases where the brittle crack initiates from any other weld areas and runs into base metal.

5 “Other weld areas” in -4 (3) includes the following: (See Fig. 10.5.1-1)

- (1) Fillet welds where hatch side coaming plating, including top plating, meets longitudinals;
- (2) Fillet welds where hatch side coaming plating, including top plating and longitudinals, meets attachments. (e.g. Fillet welds where hatch side top plating meets hatch cover pad plating.);

- (3) Fillet welds where hatch side coaming top plating meets hatch side coaming plating;
- (4) Fillet welds where hatch side coaming plating meets upper deck plating;
- (5) Fillet welds where upper deck plating meets inner hull/bulkheads;
- (6) Fillet welds where upper deck plating meets longitudinals; and
- (7) Fillet welds where sheer strakes meet upper deck plating.

6 With the consideration of the requirements in -4 above, measures specified in the following (1) to (3) are to be applied as brittle crack arrest design to prevent brittle crack propagation;

- (1) Brittle crack arrest steel is to be provided for strength deck.
- (2) Brittle crack arrest steel is to be provided for hatch side coaming; however, such steel is not necessary to be provided in the attached top plate and longitudinal stiffeners.
- (3) Appropriate measures are to be provided at a point of block-to-block butt joint between hatch side coaming and strength deck in order to arrest brittle crack propagation running straight along the butt joint.

7 Notwithstanding the requirements in -6 above, where the equivalency is verified through technical data and/or brittle fracture tests, etc., brittle crack arrest design other than those specified in -6 above may be accepted by the Society.

Fig. 10.5.1-1 Welded Parts Other Than Butt Joints

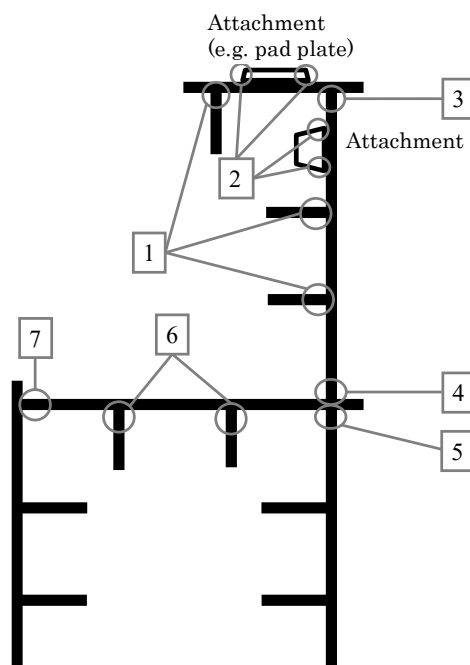

10.5.1.5 Selection of Brittle Crack Arrest Steels*

1 The brittle crack arrest steel specified in 10.5.1.4-6 (1) and (2) is to be steel plates which are considered to have the brittle crack arrest properties specified in 3.12, Part K.

2 Brittle crack arrest steel properties are to comply with Table 10.5.1-2 depending on the structural member for which it is being used and plate thickness.

3 When the brittle crack arrest steels specified in Table 10.5.1-2 are used, the weld joints between hatch side coamings and upper decks are to be fillet welds at each side without grooves or are to be partial penetration welds. Alternative weld details may be accepted only in the vicinity of ship block-to-block butt weld joints provided additional means for preventing brittle crack propagation are implemented and its validity may be confirmed by technical data or brittle fracture tests, etc. by the Society.

Table 10.5.1-2 Brittle Crack Arrest Steel Requirement in Function of Structural Members and Thickness

Structural members plating ⁽¹⁾	Thickness t (mm)	Brittle crack arrest properties
Upper deck	$50 < t \leq 100$	Steel with suffix <i>BCA6000</i> or above
Hatch side coaming	$50 < t \leq 80$	
	$80 < t \leq 100$	Steel with suffix <i>BCA8000</i> or above

Note:

(1) Excludes attached longitudinals.

Chapter 12 WELDING

12.1 Container Carrier Welding

12.1.1 Application

12.1.1.1

Fillet welding is to be applied to longitudinals with a web plate thickness above 40 *mm* and up to 80 *mm*, which are used for the strength deck or for side shell plating and longitudinal bulkheads that extend upwards from a position 0.25*D* below the strength deck.

12.1.1.2

Where longitudinals with a web plate thickness above 80 *mm* are used, the kind and size of the welding are to be at the discretion of the Society.

12.1.2 Fillet Welding

12.1.2.1

Fillet welding is to be continuous.

12.1.2.2

The size of fillet is to be not less than 8 *mm*.

Chapter 14 EQUIPMENT

14.1 Small Hatchways

14.1.1 Small Hatches Fitted on Exposed Fore Decks

14.1.1.1 General

Small hatchways providing access to cargo holds on container ships need not comply with **14.7.1, Part 1** (except for **14.7.1.2**) in cases where the following (1) to (3) are satisfied. Such hatch covers fitted at small hatchways are to be treated as non-weathertight regardless of whether they actually are weathertight.

- (1) The non-weathertight hatchways are fitted to weather decks which are at least two standard superstructure heights (as per Regulation 33 of the “International Convention on Load Lines, 1966”) above an actual freeboard deck or an assumed freeboard deck from which the freeboard can be calculated which will result in a draught not less than that corresponding to the freeboard actually assigned. Where any part of the hatchway is forward of a point located one quarter of the ship’s length ($0.25L_f$) from the forward perpendicular, that hatchway is to be located on a weather deck at least three standard superstructure heights above the actual or assumed freeboard deck.
- (2) The hatchway coamings are not less than 600 mm in height.
- (3) Bilge alarms are provided in each hold fitted with non-weathertight hatchways.

14.2 Container Securing Systems

14.2.1 Application

14.2.1.1 General

- 1 Container ships engaged in international voyages are to comply with this **14.2**.
- 2 It is important for the safety of the ship and the protection of the cargo and personnel that the cargo is secured properly especially accounting for strength of the supporting structures and securing fittings. Hereto, a scope containing the following for approval and/or certification of container securing systems is defined:

- (1) Fixed and portable container securing fittings;
- (2) Arrangement plan for fixed container securing fittings;
- (3) Drawings of container supporting structures (container posts, hatch covers, lashing bridges, and cell guides, if any);
- (4) Cargo safe access plan;
- (5) Container stowage and securing plan; and
- (6) Lashing software.

14.2.2 Fixed and Portable Container Securing Fittings

14.2.2.1 Test Certificates for Fixed and Portable Container Securing Fittings

Fittings used for container securing (hereinafter, this is to include loose securing fittings and fixed securing fittings except where specified otherwise) are to be provided with either a test certificate issued in accordance with **Chapter 9, Part L** or a test certificate deemed by the Society as being equivalent thereto.

14.2.2.2 Drawings of Fixed and Portable Container Securing Fittings

Drawings of fixed and portable container securing fittings showing dimensions, materials, design loads, and manufacturer markings are to be submitted to the Society and approved in accordance with **9.1.5, Part L**.

14.2.2.3 Arrangement Plan for Fixed Container Securing Fittings

A plan detailing the arrangement of the fixed container securing fittings is to be submitted to the Society and approved. The arrangement plan is to include the following for all areas where the fittings are installed:

- (1) The type of fixed container securing fittings such as container foundations and lashing eye plates. (Container foundations are called twistlock foundations or base foundations in different container securing contexts. Likewise, “foundation” and “socket” are used interchangeably)

(2) Unambiguous location of installed fittings such as their location relative to clearly described locations of the ship structures.

14.2.3 Container Supporting Structures

14.2.3.1 Drawings of Container Supporting Structures

1 The drawings of the structures necessary for conducting container stowage and securing are to be submitted to the Society and subject to approval.

2 The drawings are to be detailed enough to allow their model generation for structural analyses.

3 A plan is to be provided showing all relevant design loads for structural assessment of the container supporting structures and their foundations.

4 Structures involved in container stowage and securing include the following:

- (1) Hatch covers;
- (2) Container posts (Container posts are called container stanchions, container stools, or container pedestals in different container securing contexts.);
- (3) Lashing bridges; and
- (4) Cell guides.

14.2.3.2 Cell Guides

1 The gross thicknesses of cell guides are not to be less than 12 mm.

2 Cell guides and their supporting structures are to be welded in accordance with the following (1) through (3).

- (1) Welding is not to be applied to the free edges of hull structures (decks, bulkheads, hatch coamings, etc.).
- (2) In addition to (1) above, when welding is to be applied to the high stress areas of hull structures (e.g. hatch coamings) using any of KA36, KD36, KE36, KA40, KD40, KE40 and KE47 steel plates having thicknesses of over 50 mm, care is to be taken to ensure excessive stress concentrations do not occur.
- (3) The requirements of 12.2, Part 1 may be applied to the welded joints of cell guides and their supporting structures. In such cases, fillet weld leg lengths are not to be less than $F2$.

3 Cell guides and their supporting structures are to be constructed so as to be effectively loaded by brackets at appropriate intervals or other means.

4 Cell guides and their supporting structures are to be constructed so as to be able to effectively transmit loads to bulkheads or other supporting members by means of backing stiffeners to welds of hull structures (e.g. bulkheads), pad plates, etc.

5 Cell guides and their supporting structures are to be suitably reinforced so as to be able to withstand longitudinal and transverse container loads, and impact loads during cargo loading/unloading.

14.2.3.3 Lashing Bridges and Container Posts*

1 Lashing bridges and container posts are to be welded in accordance with the following (1) through (3).

- (1) Deep penetration or full penetration welding is to be applied to upper deck regions (including the tops of hatch coamings) and welding is not to be applied to free edges.
- (2) In addition to (1) above, when welding is to be applied to the high stress areas of upper deck regions (including the tops of hatch coamings) using any of KA36, KD36, KE36, KA40, KD40, KE40 and KE47 steel plates having thicknesses of over 50 mm, care is to be taken to ensure excessive stress concentrations do not occur.
- (3) The requirements of 12.2, Part 1 may be applied to the welded joints of lashing bridges and container posts. In such cases, fillet weld leg lengths are not to be less than $F2$.

2 Strength assessments of lashing bridges and container posts are to be as deemed appropriate by the Society.

14.2.3.4 Hatch Covers

Hatch covers are to be in accordance with 14.6, Part 1.

14.2.4 Cargo Safe Access Plan

14.2.4.1 General

The cargo safe access plan is to be examined for its compliance with the requirements prescribed in *MSC.1/Circ.1353/Rev.2*.

14.2.5 Container Stowage and Securing Plan

14.2.5.1 General

If the stowage and securing plan, as referred to in *MSC.1/Circ.1353/Rev.2* 4.2.1 and 4.2.2, is required by the Administration, the plan is to be submitted and subject to approval in accordance with 14.2.5.2 and 14.2.5.3.

14.2.5.2 Container Stowage Plan

The container stowage plan is to include at least the following information for each container type the ship is designed for:

- (1) Longitudinal and athwartship views of under deck and on deck stowage locations of containers including reefers as appropriate;
- (2) Alternative stowage patterns for containers of different dimensions;
- (3) Maximum stack masses;
- (4) Maximum stack heights with respect to approved sight lines; and
- (5) Maximum nominal container capacity.

14.2.5.3 Container Securing Arrangement Plan

The container securing arrangement plan is to contain all information necessary to prepare lashing calculations separately specified. The container securing arrangement plan is to include at least the following information:

- (1) Summary of ship particulars such as ship's identification number, length and breadth;
- (2) Summary of loading conditions showing relevant input parameters such as draught and *GM*;
- (3) Longitudinal views of under deck and on deck stowage locations of containers as appropriate showing nominal capacity;
- (4) Maximum stack masses;
- (5) Relevant properties of securing fittings, including permissible loads;
- (6) Graphical presentation of container and lashing arrangements in each bay on deck and in holds for sample loading conditions in accordance with the Rules of the Society for each container type the ship is allowed to carry;
- (7) Sack total mass and the sequence of masses in a stack; and
- (8) Minimum quantity of fittings required to secure containers for the presented sample loading conditions.

14.2.6 Lashing Software

14.2.6.1 General

If the ship is equipped with lashing software on board as per [3.3](#), the approval is to follow the requirements of **Annex 3.1, Part 2-1, Part C of the Rules**.

Part 2-2 BOX-SHAPED BULK CARRIERS

Chapter 1 GENERAL

1.1 General

1.1.1 Application

1.1.1.1 Application of this Part

1 The hull construction and equipment of ships intended to be registered as box-shaped bulk carriers, affixed with the notation “*Bulk Carrier modified*” (abbreviated as *BCM*), are to be in accordance with the requirements in [Part 2-2](#) in addition to [Part 1](#).

2 The requirements in [Part 2-2](#) are for ships intended for the carriage of dry cargoes in bulk, having a single deck, and a double bottom and double-side skin for the length of cargo region, but not having bilge hopper tanks and topside tanks, and decks and bottoms framed longitudinally. (See [Fig. 1.1.1-1](#))

3 Box-shaped bulk carriers with a different construction from that specified in -2 above, to which the requirements in this Part are considered to be not applicable, are to be at the discretion of the Society.

Fig. 1.1.1-1 Typical Structural Arrangements of Box-shaped Bulk Carriers

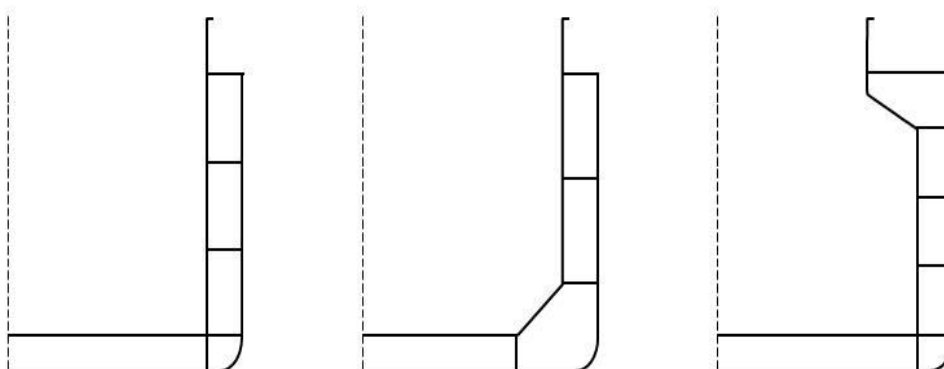

1.1.1.2 Application of Chapter XII of the SOLAS Convention

Box-shaped bulk carriers to which [Part 2-2](#) applies are to comply with the [Annex 1.1 “Additional Requirements for Bulk Carriers in Chapter XII of the SOLAS Convention”](#).

1.2 Definitions

1.2.1 Naming Convention

1.2.1.1 Structural Nomenclature

[Fig. 1.2.1-1](#) show the common structural nomenclature used in [Part 2-2](#).

Fig. 1.2.1-1 Box-shaped Bulk Carriers

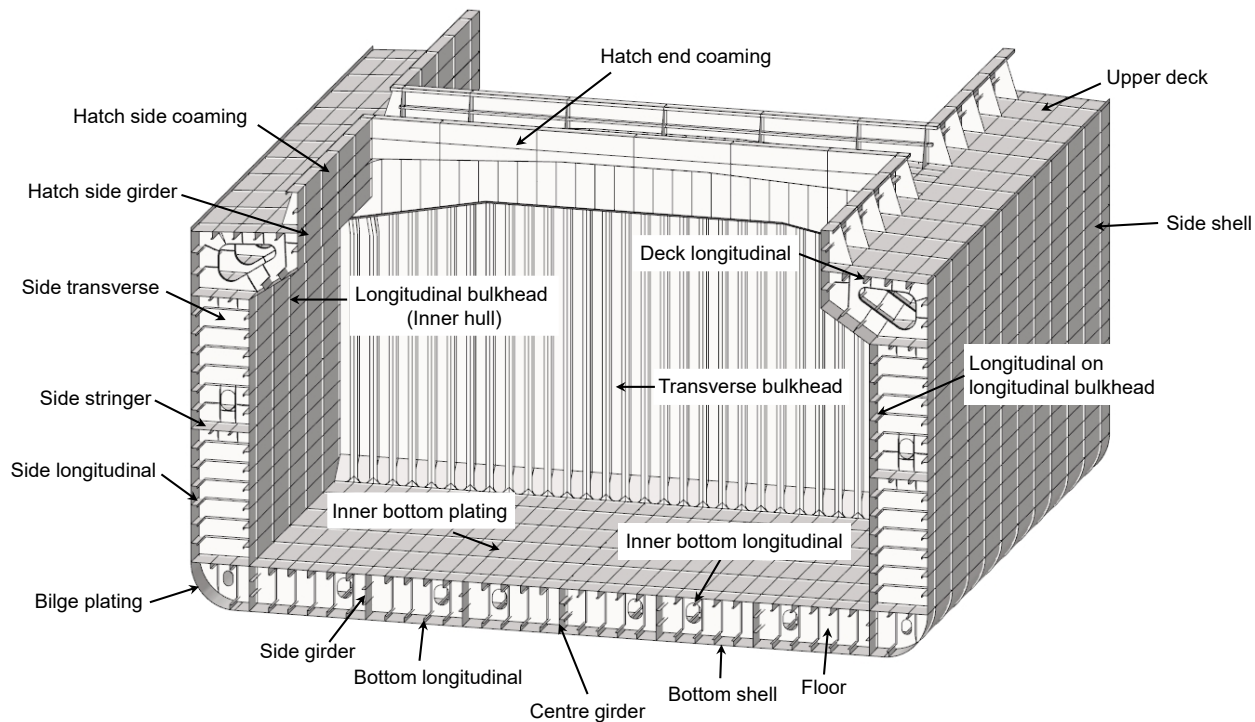

Chapter 2 GENERAL ARRANGEMENT DESIGN

2.1 Structural Arrangements

2.1.1 Double Bottoms

2.1.1.1 Structures and Arrangements of Centre Girders and Side Girders

1 Unless particularly approved by the Society, the height of the centre girder is not to be less than that obtained from the following formula. In ships having unusually large freeboards, the height of centre girders may be reduced to the values obtained using the depth to the assumed freeboard deck D' instead of D in the formula. However, this height is not to be less than $B/20$ in any circumstance.

$$15 \sqrt{\frac{L_H B D}{m}} \text{ (mm)}$$

L_H : Total length (m) of all cargo holds, excluding pump rooms and cofferdams

m : Number of holds included in the cargo space

2 When a duct keel is arranged, the centre girder may be replaced by two girders spaced at distances no greater than 3 m apart. For a spacing wider than 3 m , the two girders are to be provided with support of adjacent structure and subject to the Society's approval. Further, the structures in way of the floors are to be provided sufficient continuity of the latter.

2.1.2 Bilge Hopper Tanks

2.1.2.1 General

When bilge hopper tanks are installed, the arrangement is to be in accordance with the following (1) to (3).

- (1) Compartments of bilge hopper tanks are to be in coincidence with those of holds as far as practicable.
- (2) In bilge hopper tanks, a transverse web is to be provided at every floor.
- (3) Side girders are to be provided at the inner ends of bilge hoppers.

2.1.3 Topside Tanks

2.1.3.1 General

When a topside tank is installed, the arrangement is to be in accordance with (1) and (2) below.

- (1) Compartments of topside tanks are to be in coincidence with those of holds as far as practicable.
- (2) Transverse webs are to be provided at a spacing not exceeding 5 m in topside tanks, unless the requirements of **Chapter 8** are satisfied.

Chapter 3 STRUCTURAL DESIGN PRINCIPLES

3.1 (Deleted)

3.2 Loading Manual and Loading Instruments

3.2.1 Loading Manual

3.2.1.1 Additional Requirements for the Loading Manual

In applying the requirements of **3.8.2, Part 1**, the following (1) to (4) are to be followed.

- (1) Matters specified in **3.2.1.1-1(1) to (8), Part 2-3** are to be included in the loading manual. For ships where L_f is less than 150 m , with regard to **3.2.1.1-1(3), Part 2-3**, descriptions may be limited to the maximum allowable cargo mass for each cargo hold. Further, the issues related to **3.2.1.1-1(4), Part 2-3** may not be described.
- (2) In applying the requirements of (1) above, the loading conditions specified in **3.2.1.1-2(1) to (7), Part 2-3** are to be included in the loading manual for both departure and arrival. Further, descriptions of issues of **3.2.1.1-2(6) and (7), Part 2-3** may be limited to general restrictions and descriptions about the strength of the hull structure for cargo handling and ballasting and de-ballasting.
- (3) In applying the requirements of (1) above, when applying **3.2.1.1-1(3) and (4), Part 2-3**, the requirements of **3.2.1.2** and **3.2.1.3, Part 2-3** are also to be applied. In this case, the relevant requirements of this Part (**Chapters 4, 8**, etc.) are also to be considered.
- (4) The requirements of **3.2.1.1-3 to -8, Part 2-3** are also to be applied.

3.2.2 Loading Instruments

3.2.2.1 Additional Requirements for the Loading Instruments

In applying **3.8.3, Part 1**, the requirements of **3.2.2.1-1(1) and (3), Part 2-3** and **3.2.2.1-2, Part 2-3** are also to be applied for ships where L_f is 150 m or greater. Further, where the loading manual includes the issue relate to **3.2.1.1-1(4), Part 2-3**, the requirements of **3.2.2.1-1(2), Part 2-3** are also to be applied.

Chapter 4 LOADS

4.1 General

4.1.1 Overview

4.1.1.1 Structure and Overview of this Chapter

Each section of this Chapter defines the additional requirements shown in **Table 4.1.1-1** as the loads used for each formula and each strength assessment to determine the structural dimensions specified in each Chapter of **Part 2-2** and **Part 1**.

Table 4.1.1-1 Overview of Chapter 4

Section	Title	Overview
4.1	General	Requirements for the general principles of Chapter 4
4.2	Loads to be Considered in Longitudinal Strength	Additional requirements for hull girder loads to be considered in the torsional strength requirements specified in Chapter 5 and Chapter 5, Part 1 .
4.3	Loads to be Considered in Local Strength	Additional requirements for loads to be considered in the local strength requirements specified in Chapter 6 and Chapter 6, Part 1 .
4.4	Loads to be Considered in Strength of Primary Supporting Structures	Additional requirements for loads to be considered in the requirements of strength of primary supporting structures specified in Chapter 7 and Chapter 7, Part 1 .
4.5	Loads to be Considered in Strength Assessment by Cargo Hold Analysis	Additional requirements for loading condition, etc. to be considered in the requirements for strength assessment by cargo hold analysis specified in Chapter 8 and Chapter 8, Part 1 .
4.6	Loads to be Considered in Fatigue	Additional requirements for loads to be considered in the fatigue strength assessment requirements specified in Chapter 9 and Chapter 9, Part 1 .
4.7	Loads to be Considered in Additional Structural Requirements	Additional requirements for loads to be considered in the additional structural requirements specified in Chapter 10 and Chapter 10, Part 1 .
Annex 4.5	Operational Loading Conditions and Analytical Loading Conditions	Guidelines on the relationship between the loading condition to be considered in the strength assessment by cargo hold analysis and the loading condition described in the loading manual

4.2 Loads to be Considered in Longitudinal Strength

4.2.1 General

4.2.1.1 General

1 The loads to be considered in the longitudinal strength requirements specified in [Chapter 5](#) and [Chapter 5, Part 1](#) are also to be in accordance with the requirements of [4.2](#).

2 Additional requirements for loads in the maximum load condition are to be in accordance with the requirements of [4.2.2](#).

4.2.2 Maximum Load Condition

4.2.2.1 General

Vertical still water bending moments, vertical wave bending moments, horizontal wave bending moments, wave torsional moments are to be considered in the torsional strength assessment.

4.2.2.2 Horizontal Bending Moment and Torsional Moment

1 Horizontal wave bending moment M_{WH1} (kN-m) and wave torsional moment M_{WT1} (kN-m) are to be in accordance with [Table 4.2.2-1](#).

2 For ships where deemed necessary by the Society, horizontal wave bending moments and wave torsional moments are to be calculated by direct load analysis.

Table 4.2.2-1 Horizontal Wave Bending Moment and Wave Torsional Moment

Horizontal wave bending moment M_{WH1} (kN-m)	$M_{WH1} = 0.32C_R C_1 C_{H3} L_C^2 T_{SC} \sqrt{\frac{L_C - 35}{L_C}}$
Wave torsional moment M_{WT1} (kN-m)	$M_{WT1} = 7.0K_2 C_W^2 B^3 \left(1.75 + 1.5 \frac{e}{D_S}\right)$
Notes: C_R : Coefficient to be taken as 0.85. C_{H3} : As given by the following formulae. The mean value is calculated by linear interpolation. For $x/L_C \leq 0$, $C_{H3} = 0.0$ For $0.35 \leq x/L_C \leq 0.65$, $C_{H3} = 1.0$ For $x/L_C \geq 1.0$, $C_{H3} = 0.0$ K_2 : As given by the following formulae: For $L_C < 300$ m, $K_2 = \sqrt{1 - \left(\frac{300 - L_C}{300}\right)^2}$ For $L_C \geq 300$ m, $K_2 = 1.0$ e : Distance from baseline to shear centre at the midship section (m), as given by the following formula ⁽¹⁾ : $e = e_1 - \frac{d_0}{2}$ e_1, d_0 : As specified in 5.1.2.2(4) .	
(1) The position of the shear centre may be determined analytically without the use of formulae. This position may be determined by finding the acting point of the shearing force at which a torsional moment does not occur in the transverse section of the hull when a shearing force in the horizontal direction acts on the transverse section. (For example, this can be calculated by applying the requirements of Annex 5.2, Part 1 "Calculation of Shear Flow" .)	

4.3 Loads to be Considered in Local Strength

4.3.1 General

4.3.1.1 General

1 The loads to be considered in the local strength requirements specified in [Chapter 6](#) and [Chapter 6, Part 1](#) are also to be in accordance with the requirements of [4.3](#).

2 Additional requirements for loads in the maximum load condition are to be in accordance with the requirements of [4.3.2](#).

4.3.2 Maximum Load Condition

4.3.2.1 Lateral Loads

1 In applying 4.4.2.5, Part 1, the parameters (GM , z_G etc.) required to calculate the dynamic pressure due to cargo are to be the values in the appropriate loading condition of the full load condition, taking into account the cargo mass and density to be considered. However, Table 4.3.2-1 may be used if the values are not applicable.

2 In applying 4.4.2.4, Part 1, the parameters (GM , z_G etc.) required to calculate the dynamic pressure due to ballast water in the ballast tank are to be the values in the ballast condition. The same parameters are to be applied where the dynamic pressure due to liquid other than ballast water, such as the pressure due to fuel oil tank, is calculated. For ships that are loaded with ballast water in the ballast hold in heavy ballast conditions, the parameters required to calculate the dynamic pressure due to the ballast water in the ballast hold are to be the values in heavy ballast conditions. However, the values in Table 4.3.2-1 may be used if the values are not applicable.

Table 4.3.2-1 Simple Formulae for Parameters

Loading condition	Draught $T_{LC}(m)$ amidships	Z coordinate $z_G (m)$ of the centre of gravity of the ship	Metacentric height $GM(m)$	Radius of gyration $K_{xx} (m)$
Full load condition	T_{SC}	$0.25 \frac{B}{C_B}$	$\frac{T_{SC}}{2} + \frac{B^2}{T_{SC} C_B} \frac{3C_{W-1}}{24} - z_G$	$0.35B$
Ballast condition	T_{BAL}	$0.20 \frac{B}{C_{B,LC}}$	$\frac{T_{LC}}{2} + \frac{B^2}{T_{LC} C_{B,LC}} \frac{3C_{W,LC} - 1}{24} - z_G$	$0.40B$
Heavy ballast condition	T_{BAL-H}	$0.20 \frac{B}{C_{B,LC}}$	$\frac{T_{LC}}{2} + \frac{B^2}{T_{LC} C_{B,LC}} \frac{3C_{W,LC} - 1}{24} - z_G$	$0.40B$

4.4 Loads to be Considered in Strength of Primary Supporting Structures

4.4.1 General

4.4.1.1 General

1 The loads to be considered in the requirements for strength of primary supporting structures specified in Chapter 7 and Chapter 7, Part 1 are to be in accordance with the requirements of 4.4.

2 Additional requirements for loads in the maximum load condition are to be in accordance with the requirements of 4.4.2.

3 Additional requirements for loads in the harbour condition are to be in accordance with the requirements of 4.4.3.

4.4.2 Maximum Load Condition

4.4.2.1 General

1 The requirements for simple girders are also to be in accordance with the relevant requirements of 4.3.

2 For the requirements of double hull, the loads specified in Table 4.4.2-1 are to be considered. However, where deemed necessary by the Society, loading patterns considering loading conditions described in the loading manual may be required additionally.

Table 4.4.2-1 Loads to be Considered in Maximum Load Condition

Structures to be assessed		Loading patterns			Equivalent design wave	Difference between external and internal pressure to be considered (kN/m^2)
		Draught(m)	Vertical still water bending moment ($kN\cdot m$)	Loaded to be considered		
Double bottom	$S1^{(1)}$	T_{SC}	$M_{SV\ max}$	None	$HM-1$ $/ HM-2$	Double bottom: P_{DB} Double side: P_{DS}
	$S2^{(1)}$	T_{SC}	0	Dry bulk cargo		
	$S3$	$T_{m1\ min}^{(3)}$	$M_{SV\ min}$	Dry bulk cargo		
	$S4$	$T_{m1\ max}^{(4)}$	$M_{SV\ max}$	None		
	$S5$	T_{BAL}	$M_{SV\ max}$	None		
	$S6^{(2)}$	T_{BAL-H}	$M_{SV\ min}$	Ballast water loaded in ballast tanks and ballast hold		
Double side	$S7$	T_{SC}	$0.5M_{SV\ min}$	Dry bulk cargo	$BP-1P / BP-$ $1S$	
	$S8^{(1)}$	T_{SC}	$M_{SV\ max}$	None		

Notes:

- (1) Limited to ships designed to alternate loading conditions. $S1$ and $S8$ are applied to holds designed to empty hold, and $S2$ is applied to holds designed to loaded hold
- (2) Limited to ships designed to ballast hold. However, ballast cargo holds used only in harbour are excluded.
- (3) The minimum draught designed (m) for the loading conditions in the condition loaded/unloaded in multiple ports described in the loading manual. However, T_{BAL} is to be the lower limit.
- (4) The minimum draught designed (m) for the loading conditions in the condition loaded/unloaded in multiple ports described in the loading manual. However, T_{SC} is to be the upper limit.

4.4.2.2 External Pressure

For the requirements of double hull, the hydrostatic pressure at the draught and the hydrodynamic pressure at the equivalent design wave specified in [Table 4.4.2-2](#) are to be considered.

Table 4.4.2-2 External Pressure and Internal Pressure to be Considered

Structures to be assessed		P_{DB} (kN/m^2) ⁽¹⁾⁽²⁾	P_{DS} (kN/m^2) ⁽¹⁾⁽²⁾
Double bottom	S1 ⁽³⁾	$P_{exs} + P_{exw}$	$P_{exs} + P_{exw}$
	S2	$P_{exs} + P_{exw} - (P_{bs} + P_{bd})$	$P_{exs} + P_{exw} - (P_{bs} + P_{bd})$
	S3	$P_{exs} + P_{exw} - (P_{bs} + P_{bd})$	$P_{exs} + P_{exw} - (P_{bs} + P_{bd})$
	S4 ⁽³⁾	$P_{exs} + P_{exw}$	$P_{exs} + P_{exw}$
	S5 ⁽³⁾	$P_{exs} + P_{exw}$	$P_{exs} + P_{exw}$
	S6	$P_{exs} + P_{exw} - (P_{ls1} + P_{ld1}) - (P_{ls2} + P_{ld2})$	$P_{exs} + P_{exw} - (P_{ls1} + P_{ld1}) - (P_{ls2} + P_{ld2})$
Double side	S7	$P_{exs} + P_{exw} - (P_{bs} + P_{bd})$	$P_{exs} + P_{exw}$
	S8	$P_{exs} + P_{exw}$	$P_{exs} + P_{exw}$

Notes:

P_{exs} , P_{exw} : Hydrostatic and Hydrodynamic pressure (kN/m^2) act on bottom shell in case of P_{DB} . Those values act on side shell in case of P_{DS} . Each value is calculated in accordance with **4.6.2.4, Part 1**.

P_{bs} , P_{bd} : Static and dynamic pressure due to dry bulk cargo (kN/m^2) act on inner bottom plating in case of P_{DB} . Those values act on side shell in case of P_{DS} . Each value is calculated in accordance with **4.6.2.6, Part 1**.

P_{ls1} , P_{ld1} : Static and dynamic pressure due to liquid cargo loaded in ballast hold (kN/m^2) act on inner bottom plating in case of P_{DB} . Those values act on longitudinal bulkheads in case of P_{DS} . Each value is calculated in accordance with the following formulae.

$$P_{ls1} = P_{ls}$$

$$P_{ld1} = P_{ld}$$

P_{ls} , P_{ld} : As specified in **4.6.2.5, Part 1**

P_{ls2} , P_{ld2} : Difference of the pressure in upward and downward direction due to liquid cargo loaded in ballast tanks in double bottom construction (kN/m^2) in case of P_{DB} . Those values act on longitudinal bulkheads in case of P_{DS} . Each value is calculated in accordance with the following formulae.

$$P_{ls2} = P_{ls2a} - P_{ls2b}$$

$$P_{ld2} = P_{ld2a} - P_{ld2b}$$

P_{ls2a} , P_{ld2a} : Static pressure P_{ls} and dynamic pressure P_{ld} act on bottom shell in case of P_{DB} . Those values act on side shell in case of P_{DS} .

P_{ls2b} , P_{ld2b} : Static pressure P_{ls} and dynamic pressure P_{ld} act on inner bottom plating in case of P_{DB} . Those values act on side shell in case of P_{DS} .

(1) The parameters (GM , z_G , K_{XX}) required to calculate loads is given by the follows.

S1, S2, S7, S8 : As given by the formulae in full load condition in **Table 4.3.2-1**.

S3 : As given by the formulae in ballast condition in **Table 4.3.2-1**. However, the value calculated based on the weight distribution according to the loading condition to be considered can be used

S4 : As given by the formulae in full load condition in **Table 4.3.2-1**. However, the value calculated based on the weight distribution according to the loading condition to be considered can be used

S5 : As given by the formulae in ballast condition in **Table 4.3.2-1**.

S6 : As given by the formulae in heavy ballast condition in **Table 4.3.2-1**.

(2) Load calculation points is in accordance with **7.3.1.5, Part 1** for all loading conditions. Where pipe ducts are arranged in the ballast tanks in

double bottom construction, in the case of $S6$, the value of y_{DH} in calculation points is taken as the location of the boundary between the pipe duct and ballast tank, and the pressure due to ballast water in the said tank is to be calculated.

- (3) P_{exw} is to be not less than the value of P_{exw} for $HM-2$ at x_G , which is the X coordinate (m) at the centre of gravity of the ship.

4.4.2.3 Internal Pressure

1 For the requirements of double hull, the internal pressure due to dry bulk cargo, or due to loaded liquid specified in [Table 4.4.2-2](#) are to be considered.

2 Mass of dry bulk cargo to be considered in -1 above is to be in accordance with the following (1) and (2). In any cases, cargo is assumed to be loaded up to the top of hatch coaming and the cargo density may be calculated by divided the said mass into the volume of cargo hold (V_{Full} specified in [4.6.2.6, Part 1](#)).

(1) Loading pattern $S2$: M_{HD} specified in [4.6.2.6, Part 1](#)

(2) Loading pattern $S3$ and $S7$: M_{Full} and M_H specified in [4.6.2.6, Part 1](#), whichever is greater.

3 In applying -1 above, internal pressure due to ballast water loaded in ballast holds and ballast tanks is to be considered in loading pattern $S6$.

4.4.2.4 Vertical Bending Moment

1 For the requirements of double hull, the vertical still water bending moment and the vertical wave bending moment in the equivalent design wave specified in [4.4.2.1-2](#) are to be considered.

2 The vertical wave bending moment considered for each equivalent design wave is to be in accordance with [4.6.2.10, Part 1](#).

4.4.3 Harbour Condition

4.4.3.1 General

For the requirements of double hull, the loads specified in [Table 4.4.3-1](#) are to be considered.

Table 4.4.3-1 Loads to be Considered in Harbour Condition

Structures to be assessed		Loading pattern			Difference between external and internal pressure to be considered (kN/m^2)
		Draught(m)	Vertical bending moment in harbour ($kN-m$)	Loaded to be considered	
Double bottom	$P1$	$T_{P-min}^{(1)}$	$\max(M_{PT-min} , M_{PT-max})$	Dry bulk cargo	Double bottom: P_{DB} Double side: P_{DS}
	$P2$	$T_{P-max}^{(2)}$	$\max(M_{PT-min} , M_{PT-max})$	0	
Double side	$P3$	$T_{P-min}^{(1)}$	$\max(M_{PT-min} , M_{PT-max})$	Dry bulk cargo	
	$P4$	$T_{P-max}^{(2)}$	$\max(M_{PT-min} , M_{PT-max})$	0	

Notes:

(1) The minimum draught designed (m) for the loading conditions in the harbour described in the loading manual.

(2) The maximum draught designed (m) for the loading conditions in the harbour described in the loading manual.

4.4.3.2 External Pressure

For the requirements of double hull, the hydrostatic pressure at the draught specified in [Table 4.4.3-2](#) is to be considered.

Table 4.4.3-2 External Pressure and Internal Pressure to be Considered

Structures to be assessed		$P_{DB}(kN/m^2)^{(1)}$	$P_{DS}(kN/m^2)^{(1)}$
Double bottom	P1	$P_{exs} - P_{bs}$	$P_{exs} - P_{bs}$
	P2	P_{exs}	P_{exs}
Double side	P3	$P_{exs} - P_{bs}$	$P_{exs} - P_{bs}$
	P4	P_{exs}	P_{exs}
Notes:			
P_{exs} : Hydrostatic pressure (kN/m^2) act on bottom shell in case of P_{DB} . Those values act on side shell in case of P_{DS} . Each value is calculated in accordance with 4.6.2.4, Part 1 .			
P_{bs} : Static pressure due to dry bulk cargo (kN/m^2) act on inner bottom plating in case of P_{DB} . Those values act on longitudinal bulkhead in case of P_{DS} . Each value is calculated in accordance with 4.6.2.6, Part 1 .			
(1) Load calculation points is in accordance with 7.3.1.5, Part 1 for all loading conditions			

4.4.3.3 Internal Pressure

For the requirements of double hull, the internal pressure due to dry bulk cargo is to be considered in accordance with the requirements of **Table 4.4.3-1**. The mass of dry bulk cargo to be considered is to be M_{Full} specified in **4.6.2.6, Part 1**. The cargo density may be calculated by divided the said mass into the volume of cargo hold (V_{Full} specified in **4.6.2.6, Part 1**)

4.4.3.4 Vertical Bending Moment in the Harbour

For the requirements of double hull, the vertical bending moment in harbour specified in **4.4.3.1** is to be considered.

4.5 Loads to be Considered in Strength Assessment by Cargo Hold Analysis

4.5.1 General

4.5.1.1 General

1 The loads to be considered in the strength assessment by the cargo hold analysis specified in **Chapter 8** and **Chapter 8, Part 1** are also to be in accordance with the requirements of **4.5**.

2 Additional requirements for loads in the maximum load condition are to be in accordance with the requirements of **4.5.2**.

3 Additional requirements for loads in the harbour condition are to be in accordance with the requirements of **4.5.3**.





4.5.2 Maximum Load Condition

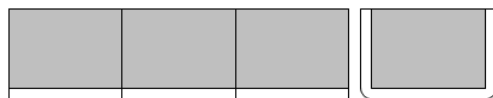
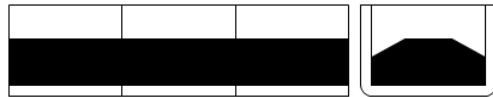
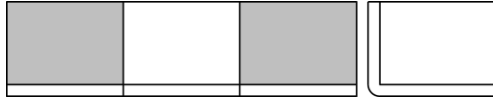
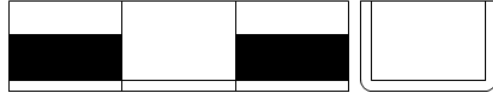

4.5.2.1 Loading Conditions

1 In applying **4.6.2.1, Part 1**, in addition to the homogeneous full load and ballasted condition, for ships designed for loading cargo with heigh density cargo, alternate loading, multi-port loading/unloading and block loading, the corresponding loading conditions are to be considered among the loading condition specified in **Table 4.5.2-1**. However, the loading pattern corresponding to the loading condition that is not allowed in operation may not be considered.

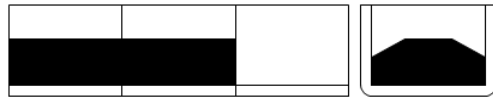
2 Notwithstanding the requirements in -1 above, additional requests may be given to consider the loading conditions specified in the loading manual.

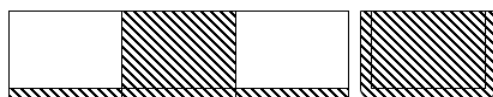
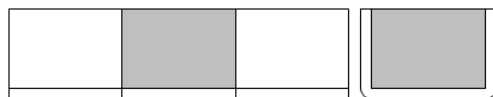
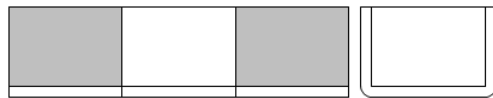
Table 4.5.2-1 Loading Conditions to be Considered in Maximum Load Condition

Loading condition	Loading pattern		Draught	Vertical still water bending moment M_{SV}	Equivalent design wave
Full load condition (homogeneously loaded)	S1		T_{SC}	$0.5M_{SV_min}^{(7)}$	HM-1 FM-1 BP-1P/S BR-1P/S
	S2		T_{SC}	$0.5M_{SV_min}^{(7)}$	HM-1 FM-1 BP-1P/S BR-1P/S
Full load condition (alternate loading, block loading)	S3		T_{SC}	M_{SV_max}	HM-2 FM-2 BP-1P/S BR-1P/S
	S4 ⁽²⁾		T_{SC}	M_{SV_max}	HM-2 FM-2 BP-1P/S BR-1P/S
	S5		T_{SC}	0	HM-1 FM-1
	S6		T_{SC}	$M_{SV_max}^{(8)}$	HM-2 FM-2
$M_{SV_min}^{(9)}$				HM-1 FM-1	
Ballast condition	S7		T_{BAL}	$M_{SV_max}^{(8)}$	HM-2 FM-2 BP-1P/S BR-1P/S
	S8 ⁽³⁾		T_{BAL-H}	$M_{SV_min}^{(9)}$	HM-1 FM-1 BP-1P/S BR-1P/S
Condition loaded/unloaded in multiple ports ⁽¹⁾	S9		$T_{m1_min}^{(5)}$	$M_{SV_min}^{(8)}$	HM-1 FM-1 BP-1P/S BR-1P/S
	S10 ⁽⁴⁾		$T_{m2_max}^{(6)}$	$M_{SV_max}^{(9)}$	HM-2 FM-2 BP-1P/S BR-1P/S

: Dry bulk cargo (mass in homogeneous full load condition:/the other conditions: M_{Full} , mass of alternate loading condition: M_{HD})
: Cargo with high density cargo (mass of homogeneous full load condition:/other condition: M_H , mass of alternate loading: M_{HD})
: Ballast water

- (1) The radius of gyration (m) around the X -axis is taken to be $0.38B$. However, the value calculated based on the weight distribution according to the loading condition to be considered can be used.
- (2) When conducting a strength assessment while taking the loading condition $S3$ into consideration, $BR-1P/S$ and $BP-1P/S$ wave conditions may be omitted.
- (3) Limited to strength assessment of ballast cargo hold.
- (4) When conducting a strength assessment while taking the loading condition $S3$ into consideration, this loading condition may be omitted.
- (5) The minimum draught designed (m) for loading conditions corresponding to the loading condition $S9$ of the multi-port loading/unloading described in the loading manual.
- (6) The maximum draught designed (m) for loading conditions corresponding to the loading condition $S10$ of the multi-port loading/unloading described in the loading manual.
- (7) If the vertical still water bending moment is less than $0.5M_{SV_min}$ in loading conditions $S1$ and $S2$, said moment is to be taken into consideration.
- (8) In the loading condition to be considered, instead of M_{SV_max} , the maximum vertical still water bending moment that occurs after considering all possible physical combinations, such as fully loaded or empty consumable tank, can be used.
- (9) In the loading condition to be considered, instead of M_{SV_min} , the minimum vertical still water bending moment that occurs after considering all possible physical combinations, such as fully loaded or empty consumable tank, can be used.

4.5.2.2 Hull Girder Loads

In applying [4.6.2.10, Part 1](#), the vertical still water bending moment for the loading condition under consideration is to be in accordance with the requirements of [4.5.2.1](#).

4.5.3 Harbour Condition

4.5.3.1 Loading Conditions

In applying [4.6.3.1, Part 1](#), the loading conditions specified in [Table 4.5.3-1](#) are to be considered.

Table 4.5.3-1 Loading Conditions to be Considered in Harbour Condition

Loading condition	Loading pattern			Draught	Vertical bending moment in harbour
Harbour condition	P1		$T_{P1-max}^{(1)}$	M_{PT_max}	
				M_{PT_min}	
	P2		$T_{P2-min}^{(2)}$	M_{PT_max}	
				M_{PT_min}	
	P3		$T_{P3-min}^{(3)}$	M_{PT_max}	
				M_{PT_min}	
	P4		$T_{P4-max}^{(4)}$	M_{PT_max}	
				M_{PT_min}	
Notes: (1) The maximum draught designed (m) for loading conditions corresponding to the loading condition P1 of the loading conditions in the harbour condition described in the loading manual. (2) The minimum draught designed (m) for loading conditions corresponding to the loading condition P2 of the loading conditions in the harbour condition described in the loading manual. (3) The minimum draught designed (m) for loading conditions corresponding to the loading condition P3 of the loading conditions in the harbour condition described in the loading manual. (4) The maximum draught designed (m) for loading conditions corresponding to the loading condition P4 of the loading conditions in the harbour condition described in the loading manual.					

4.5.3.2 Hull Girder Loads

In applying 4.6.3.5, Part 1, the vertical bending moment in harbour for the loading condition under consideration is to be in accordance with the requirements of 4.5.3.1.

4.6 Loads to be Considered in Fatigue

4.6.1 General

4.6.1.1 General

1 The loads to be considered in the fatigue strength assessment specified in Chapter 9 and Chapter 9, Part 1 are also to be in accordance with the requirements of 4.6.





2 Additional requirements for loads in the cyclic load condition are to be in accordance with the requirements of 4.6.2.

4.6.2 Cyclic Load Condition

4.6.2.1 Loading Conditions

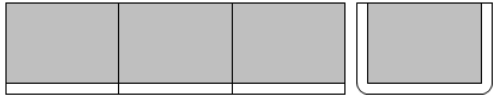
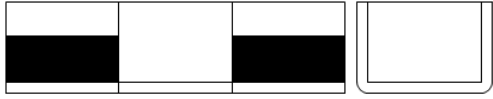
In applying 4.7.2.1, Part 1, the loading conditions specified in Table 4.6.2-1 are to be considered. Where the loading patterns specified in Table 4.6.2-1 are different with the actual patterns because of the tank arrangements, etc., the pattern based upon the loading conditions specified in the loading manual may be considered.

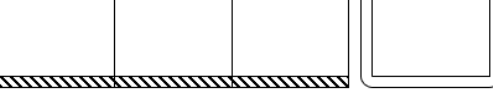
Table 4.6.2-1 Loading Conditions to be Considered in Cyclic Load Condition

Loading condition	Loading pattern		Draught	Vertical still water bending moment	Equivalent design wave
Full load condition (homogeneously loaded)	FA1		T_{SC}	Values in the loading conditions under consideration	HM FM BR BP
					
Full load condition (alternate loading)	FA3(2)		T_{SC}		
					
Ballast condition	FA5(3)		T_{BAL-H}		
■, ■■■, ▨: As specified in Table 4.5.2-1.					
Notes: (1) Limited to ships designed to alternate loading conditions, and when conducting a strength assessment of an empty hold. (2) Limited to ships designed to alternate loading conditions, and when conducting a strength assessment of a loaded hold. (3) This only applies when conducting a strength assessment of a ballast hold.					

4.7 Loads to be Considered in Additional Structural Requirements

4.7.1 General

4.7.1.1 General

1 The loads to be considered in the additional structural requirements specified in Chapter 10 and Chapter 10, Part 1 are also to be in accordance with the requirements of 4.7.

2 Additional requirements for loads in the maximum load conditions are to be in accordance with the requirements of 4.7.2.

4.7.2 Maximum Load Condition

4.7.2.1 Steel Coil Loads

For ships loaded with steel coils, the steel coil loads specified in [4.4.2.1, Part 2-5](#) are to be considered.

Annex 4.5 OPERATIONAL LOADING CONDITIONS AND ANALYTICAL LOADING CONDITIONS

An1. General

An1.1 General

An1.1.1

1 The purpose of this Annex is to specify the relationship between analytical loading conditions and operational loading conditions for reference purposes.

An2. Operational Loading Conditions and Analytical Loading Conditions













An2.1 Operational Loading Conditions

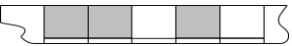
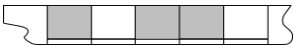

An2.1.1

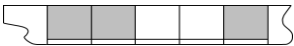
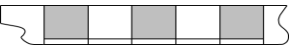
1 Operational loading conditions refers to “all loading conditions assumed in the design of individual vessels”. This means a combination of loading conditions for each tank in all cargo areas as specified in the loading manual. Such conditions, however, do not include ones that are either directly or indirectly prohibited by the loading manual (i.e. conditions that are substantially restricted by the allowable values for the vertical still water bending moment, allowable values for the vertical still water shear force, draught, etc.).

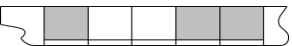
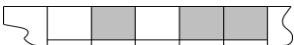
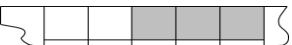
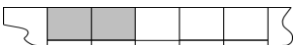
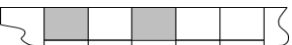
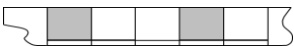
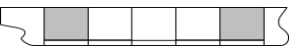
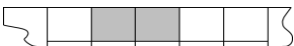
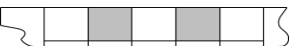
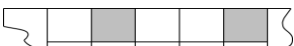
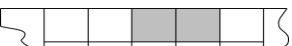
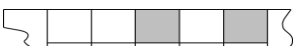
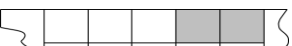
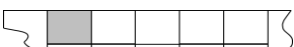
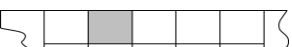
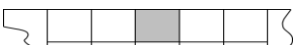
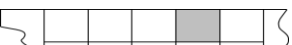
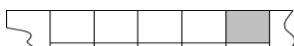
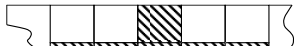
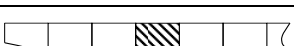
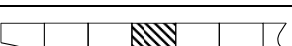
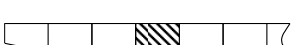
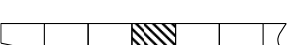
2 Where evaluating a box-type bulk carrier with five holds, the possible operational loading conditions are shown in [Fig. An1](#), except the half-loaded condition of each tank or the condition of loading high density cargo. Where there are the conditions of loading high density cargo or a ballast conditions that the ballast hold is not full, the analytical loading conditions may be used the load pattern of the operational loading conditions as shown in [Fig. An1](#).

Fig. An1 Example Operational Loading Conditions (Five Hold Box-type Bulk Carrier)

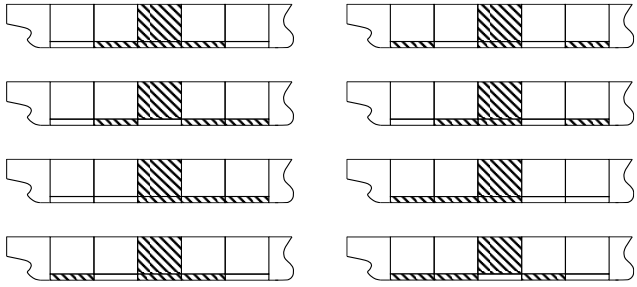
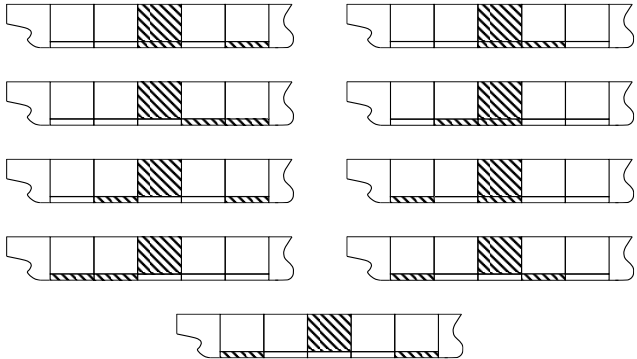
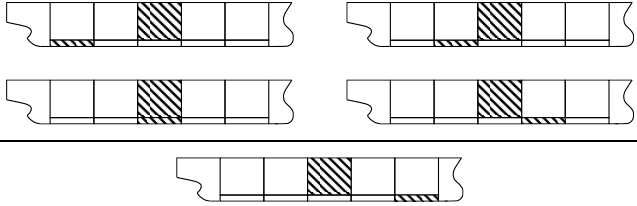
Operational loading conditions	
Full-load condition	
One-hold-empty condition	    
Two-hold-empty condition	         
Three-hold-empty condition	         
Four-hold-empty condition	    
Ballast condition (Ballast tank/hold Full)	
Ballast condition (1 Ballast tank empty)	    

<p>Ballast condition (2 Ballast tank empty)</p>	
<p>Ballast condition (3 Ballast tank empty)</p>	
<p>Ballast condition (4 Ballast tank empty)</p>	
<p>Ballast condition (Ballast tank empty)</p>	

An2.2 Analytical Loading Conditions

An2.2.1

1 Analytical loading conditions refers to “loading conditions reproduced using partial structural models in order to appropriately analyse structural responses that may occur in the operational loading conditions of [An2.1.1-1](#).”

An2.3 Example Operational Loading Conditions and Analytical Loading Conditions

An2.3.1 General

1 Where evaluating the operational loading conditions of a box-type bulk carrier with five holds (See [Fig. An1](#)), the analytical loading conditions to be examined differ depending on the target hold. For example, refer to [Fig An2](#) and [Fig An3](#), respectively, may be used to evaluating the No. 3 hold and the No. 4 hold. In general, the analytical loading conditions are to be considered for the target hold: full load condition, empty condition, ballast load condition, and, when high density cargo loaded, high density load condition.





2 When considering the requirements of [Table 4.5.2-1 \(8\)](#) or [\(9\)](#), it is necessary to calculate the maximum or minimum vertical still water bending moment that can physically exist by filling or emptying each tank (including consumable tanks) based on the operational loading conditions corresponding to [Fig. An2](#) and [Fig. An3](#).

3 Regardless of the applicable operational loading conditions in [Fig. An2](#) and [Fig. An3](#), it is also necessary to consider all loading conditions described in loading manuals that are deemed severe for hull structures.

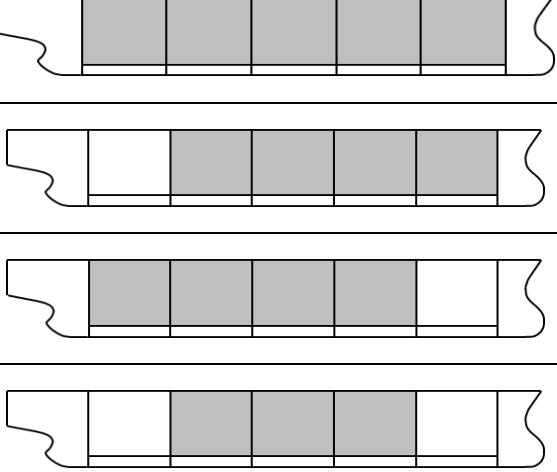
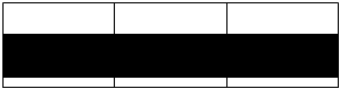
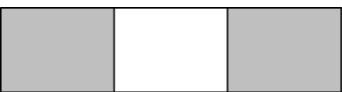
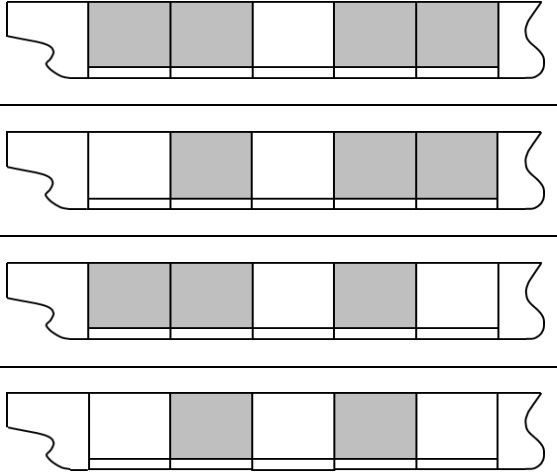
For example, special loading conditions such as where there are several types of cargo to be loaded or the cargo holds are temporarily filled with ballast water are candidates. If the loading conditions which selected for the analytical loading conditions envelope the structural strength of the hull in these loading conditions, they may be omitted.

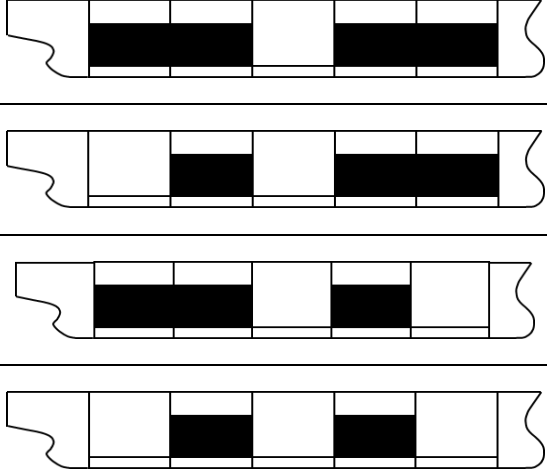

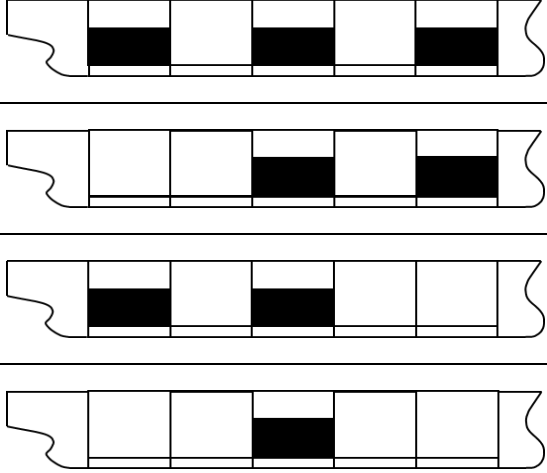
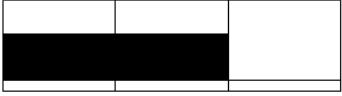
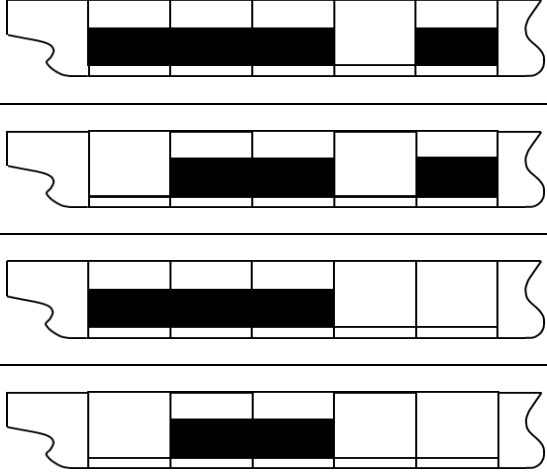

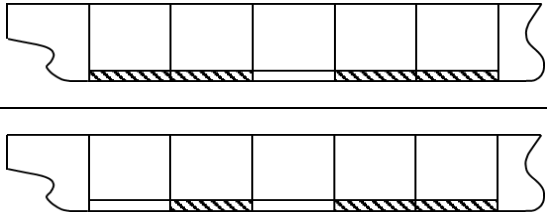
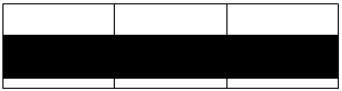
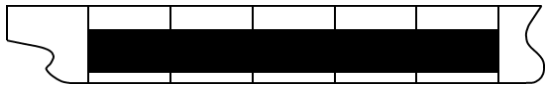
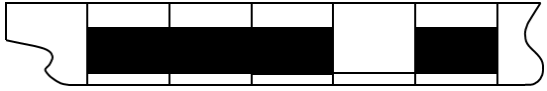
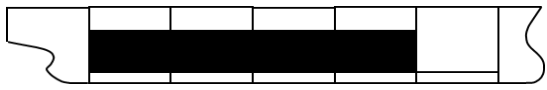
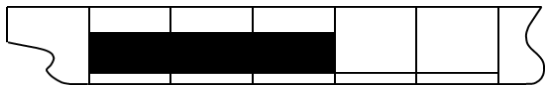

Fig. An2 Analytical Loading Conditions and Operational Loading Conditions
for No. 3 Cargo Hold Evaluations





	Analytical loading condition	Operational loading condition that is the basis for the analytical loading condition
S1		
S2		
S3 S10		



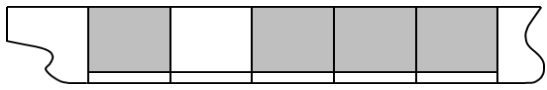
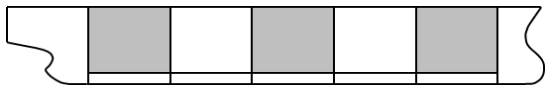
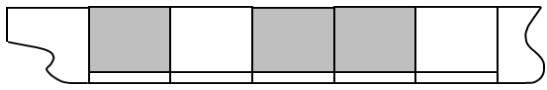
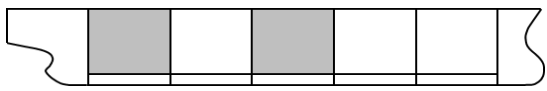

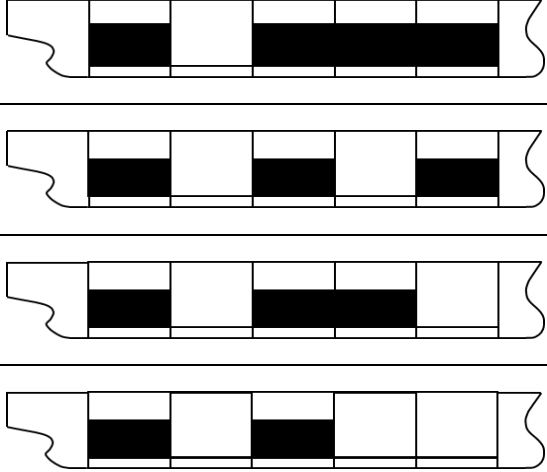

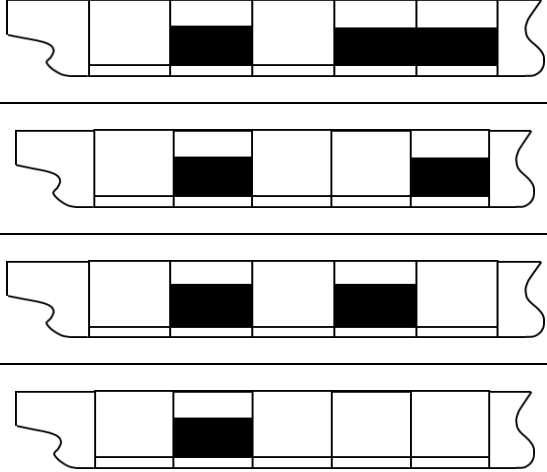

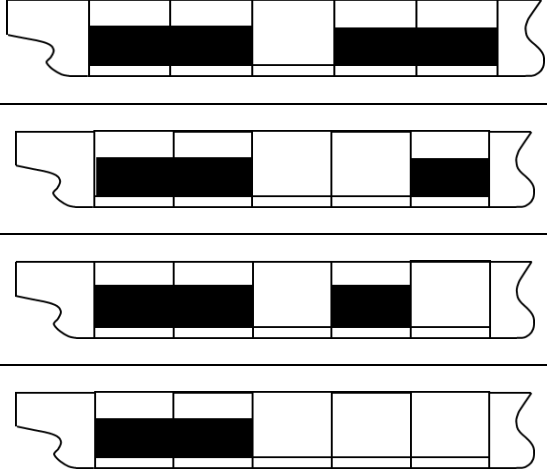
<p>S4</p>		
<p>S5</p>		
<p>S6</p>		
<p>S7</p>		

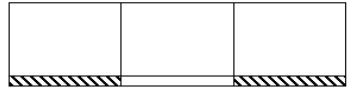
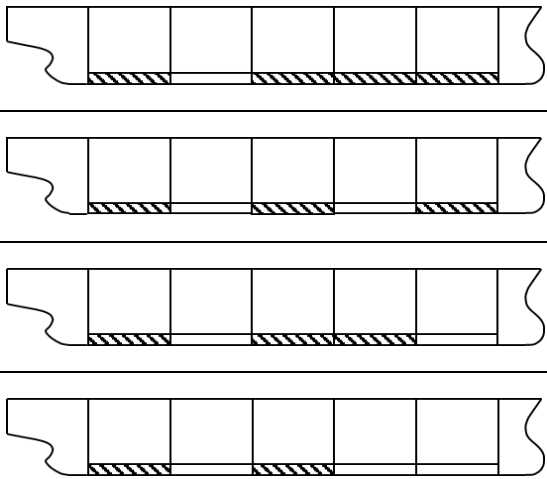
<p>S8</p>		
<p>S9</p>		
<p> : Bulk dry cargo : High density cargo : Ballast water </p>		

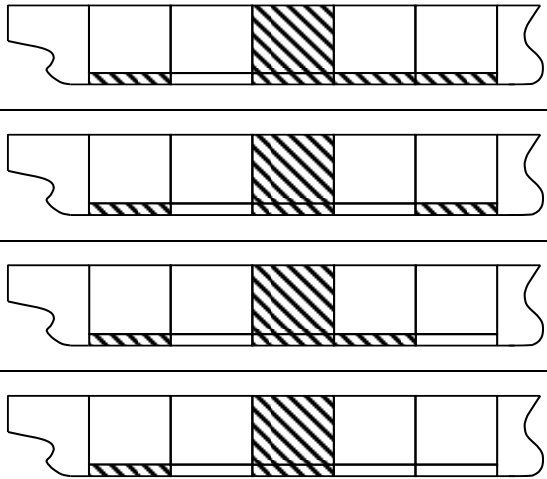
Fig. An3 Analytical Loading Conditions and Operational Loading Conditions
for No. 4 Cargo Hold Evaluations

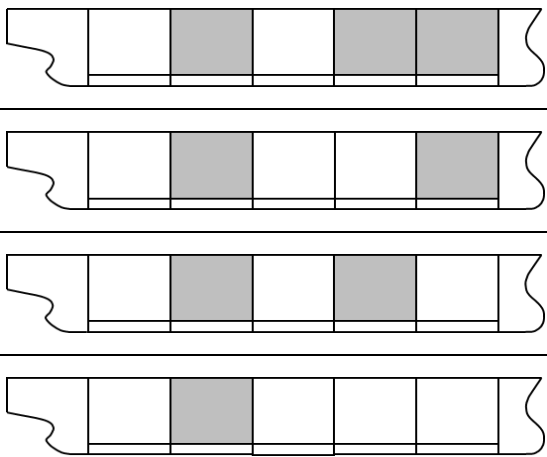
	Analytical loading condition	Operational loading condition that is the basis of the analytical loading condition
S1		
		
		
		
S2		
		
		
		
S3 S10		
		
		
		

<p>S4</p>		
<p>S5</p>		
<p>S6</p>		

<p>S7</p>		
<p>S8</p>		
<p>S9</p>		
<p>  Bulk dry cargo  High density cargo  Ballast water </p>		

An2.3.2 Double Bottom Tanks

1 The maximum or minimum vertical still water bending moment that occurs for all loading conditions (excluding the ballast condition) after considering all possible combinations such as the fully loaded or empty condition of consumable tanks, etc. In such cases, the loading condition to be used for a double bottom tank is the severest operational loading condition.

An2.3.3 Loading Conditions that Differ from Analytical Loading Conditions

1 In cases where it is difficult to say that it is appropriate to consider the analytical loading conditions required in [4.5.2](#) due to reasons such as the boundary position of the ballast tank being different, the fuel oil tank being located in the cargo hold analysis modelling range, the size of the cargo hold before and after the target hold being significantly different, etc., the loading conditions to be considered are determined on a case-by-case basis, and such loading conditions are to be the ones deemed to be severe for the hull structure of the ship in question.

2 The following **(1)** to **(4)** items are to be considered when applying **-1** above:

- (1) Difference between internal pressure and external pressure acting on the ship bottom structure or ship side structure
- (2) Internal pressure acting on the bulkhead structure
- (3) Relationship between draught and cargo
- (4) Vertical still water bending moment

Chapter 5 LONGITUDINAL STRENGTH

5.1 Torsional Strength

5.1.1 General

5.1.1.1 Application

1 Torsional strength assessment specified in 5.1.2 is to be conducted for the following ships (1) or (2):

- (1) In case where the widths of the hatchway amidship exceed $0.7B$
- (2) In cases where deemed necessary by the Society.

2 Notwithstanding the requirements of this Chapter, requests may be given to conduct torsional strength assessments in accordance with direct load analyses and finite element analysis when deemed appropriate by the Society.

5.1.2 Torsional Strength Assessment Based on Formulae

5.1.2.1 General

The procedure for torsional strength assessment is given in the following (1) and (2):

- (1) Vertical still water bending moments, vertical wave bending moments, horizontal wave bending moments and wave torsional moments are to be considered as applied loads.
- (2) The strength assessment is to be carried out based upon the evaluation stress determined by combining each stress obtained from the loads specified in (1) above.

5.1.2.2 Calculation of Stresses Due to Vertical Bending Moment, Horizontal Bending Moment and Torsional Moment

Stresses due to vertical bending moment, horizontal moment and torsional moment are to be in accordance with the following (1) to (4).

- (1) The stress due to vertical still water bending moment σ_{SV} (N/mm^2) are to be obtained from the following formula:

$$\sigma_{SV} = \frac{|M_{SV}|}{Z_{V-gr}} \times 10^3$$

M_{SV} : Vertical still water bending moment ($kN-m$) for the load cases “hogging” and “sagging” as specified in 4.3.2.2, Part 1

Z_{V-gr} : Section modulus (cm^3) for the hull girder vertical bending at the strength deck at the cross-section position under consideration (gross scantling)

- (2) The stress due to vertical wave bending moment σ_{WV} (N/mm^2) is to be obtained from the following formula:

$$\sigma_{WV} = \frac{M_{WV}}{Z_{V-gr}} \times 10^3$$

M_{WV} : Vertical wave bending moment ($kN-m$) for the load cases “hogging” and “sagging” as specified in 4.3.2.3, Part 1

Z_{V-gr} : Section modulus (cm^3) for the hull girder vertical bending at the strength deck at the cross-section position under consideration (gross scantling)

- (3) The stress due to horizontal wave bending moment σ_{WH} (N/mm^2) is to be obtained from the following formula:

$$\sigma_{WH} = \frac{M_{WH1}}{Z_{H-gr}} \times 10^3$$

M_{WH1} : Horizontal wave bending moment ($kN-m$) specified in 4.2.2.1-2.

Z_{H-gr} : Section modulus (cm^3) for the hull girder horizontal bending at the hatch side at the cross-section position under consideration (gross scantling)

- (4) The stress due to wave torsional moments σ_{WT} (N/mm^2) is to be obtained using the following formula:

For ships having ordinary structure, the stress is calculated using the scantlings at the midship section. Values for ships other than those above are to be at the discretion of the Society.

$$\sigma_{WT} = 0.000318 \frac{\omega \ell_c M_{WT1}}{I_\omega + 0.04 \ell_c^2 J}$$

M_{WT1} : Wave torsional moment ($kN-m$) as shown in 4.2.2.1-1

$$\omega = \frac{B_1}{2}(D_1 - e_1) + \frac{d_1}{2}(D_1 + e_1)$$

$$D_1 = D_S - \frac{d_0}{2}$$

$$B_1 = B - d_1$$

$$e_1 = \frac{(3D_1 - d_1)d_1 t_{d-gr} + (D_1 - d_1)^2 t_{s-gr}}{3d_1 t_{d-gr} + 2(D_1 - d_1)t_{s-gr} + B_1 t_{b-gr}/3}$$

d_0 : Height (m) of double bottom, as shown in Fig. 5.1.2-1.

d_1 : Breadth (m) of double hull side, as shown in Fig. 5.1.2-1.

t_{d-gr} , t_{s-gr} and t_{b-gr} : Mean thickness (m) of deck, ship sides, and bottom based on the gross scantling, as given in Fig. 5.1.2-1. When calculating mean thickness, the longitudinal members included in this range may be included.

ℓ_C : Distance (m) from the collision bulkhead to watertight bulkhead of the fore end of the machinery room

$$I_\omega = B_1^2 \{d_1 t_{d-gr} I_d + (D_1 - d_1) t_{s-gr} I_s + B_1 t_{b-gr} I_b\}$$

$$I_d = (D_1 - e_1) \left\{ \frac{3}{2} (D_1 - e_1) - d_1 \right\} + \frac{d_1^2}{3}$$

$$I_s = (D_1 - d_1) \left\{ \frac{1}{3} (D_1 - d_1) - e_1 \right\} + e_1^2$$

$$I_b = \frac{e_1^2}{6}$$

J: As given by the following formula:

$$J = \frac{2\{Bd_0 + 2(D_S - d_0)d_1\}^2}{\frac{3d_1}{t'_{d-gr}} + \frac{2(D_1 - d_1)}{t'_{s-gr}} + \frac{B_1}{t'_{b-gr}}}$$

t'_{d-gr} , t'_{s-gr} , t'_{b-gr} : Mean thickness (m) of deck, ship sides and bottom based on the gross scantling. When calculating mean thickness, only the strong deck, side shell plating, bottom shell plating, inner bottom plating, and longitudinal bulkheads is to be used, and other longitudinal members are not to be included.

Fig. 5.1.2-1 Mean Thickness of Deck, Ship Sides and Bottom

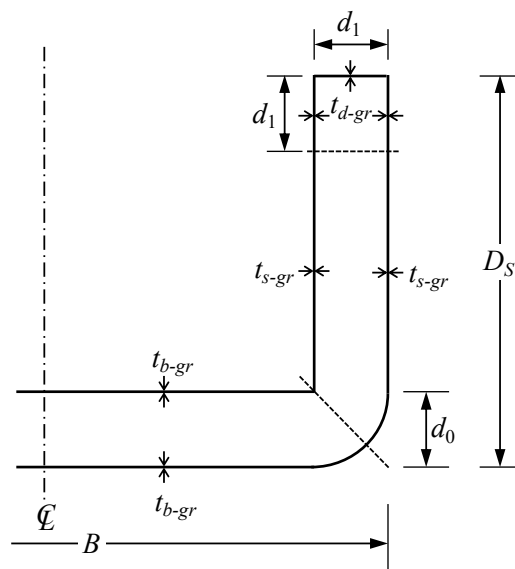

5.1.2.3 Evaluated Stress

Evaluated stress σ_T (N/mm^2) is to be determined in accordance with the following formula:

$$\sigma_T = \sqrt{(0.75\sigma_{WV})^2 + \sigma_{WH}^2 + \sigma_{WT}^2 + \sigma_{SV}}$$

σ_{SV} : Stress due to the vertical still water bending moment (N/mm^2) specified in 5.1.2.2 (1).

σ_{WV} : Stress due to vertical wave bending moment (N/mm^2), specified in 5.1.2.2 (2).

σ_{WH} : Stress due to horizontal wave bending moment (N/mm^2), specified in **5.1.2.2 (3)**.

σ_{WT} : Warping stress due to torsional wave moment (N/mm^2), specified in **5.1.2.2 (4)**.

5.1.2.4 Evaluation

The evaluated stress σ_T (N/mm^2) at any cross-sectional position from the collision bulkhead to watertight bulkhead of the fore end of the machinery room is to satisfy the following criteria.

$$\sigma_T \leq \frac{175}{K}$$

5.2 Hull Girder Ultimate Strength

5.2.1 Strength Criteria

5.2.1.1 Effect of Double Bottom Bending

In the assessment specified in **5.4.2.2, Part 1**, the coefficient γ_{DB} that takes into account the effect of double bottom bending is as follows.

Holds emptied when in a full load condition: $\gamma_{DB} = 1.25$

Other holds: $\gamma_{DB} = 1.15$

Chapter 6 LOCAL STRENGTH

6.1 Ships Loaded with Special Cargo

6.1.1 General

6.1.1.1

Where loads of cargoes are not to be regarded as distributed loads, [6.1](#) is to be followed.

6.1.2 Ships Loaded with Steel Coils

6.1.2.1 Plates and Stiffeners

Plates and stiffeners for ships loaded with steel coils are to be in accordance with [10.1, Part 2-5](#).

6.1.3 Ships Loaded with Vehicles (Including Cases Where Vehicles Are Used During Cargo Handling)

6.1.3.1 Plates and Stiffeners

1 The plates and stiffeners of the deck and inner bottom on which vehicles are loaded are to be in accordance with [10.1, Part 2-6](#).

2 Where plates and stiffeners are subjected to concentrated loads from wheels during cargo handling that vehicles such as forklifts are used, the plates and stiffeners are to be in accordance with [10.1, Part 2-6](#).

6.1.4 Ships Loaded with Other Special Cargo

6.1.4.1

Ships loaded with special cargo other than that described in [6.1.2](#) and [6.1.3](#) above are to be as deemed appropriate by the Society, taking into consideration the mode of action of the load by each cargo.

6.2 Transverse Bulkheads

6.2.1 Plane Bulkheads

6.2.1.1 Bulkhead Stiffeners

Bulkhead stiffeners directly below a deck girder are to be in accordance with [10.3, Part 2-5](#).

Chapter 7 STRENGTH OF PRIMARY SUPPORTING STRUCTURES

7.1 General

7.1.1 Application

7.1.1.1

1 The requirements of this Chapter apply to ships of less than 150 m in ship length L_C .

2 Notwithstanding -1 above, strength assessments for deck girders with respect to deck loads and green sea loads are to be carried out in accordance with this Chapter.

3 For the double bottom and double-side skin construction, the requirements of the double hull structure specified in **7.3, Part 1** are to be applied. For other girder members that can be regarded as simple girders, the requirement of the simple girder specified in **7.2, Part 1** are to be applied.

7.1.1.2 Application Example of Assessment Model

1 An application example of assessment model applying **7.2** and **7.3, Part 1** is shown in **Fig. 7.1.1-1**.

2 For girder members that have a structure not shown in **Fig. 7.1.1-1** and can be regarded as a simple girder, the boundary conditions and acting load are to be considered, and the assessment model from **Table 7.2.1-2, Part 1** is to be appropriately selected.

Fig. 7.1.1-1 Application Example for Box-shaped Bulk Carriers

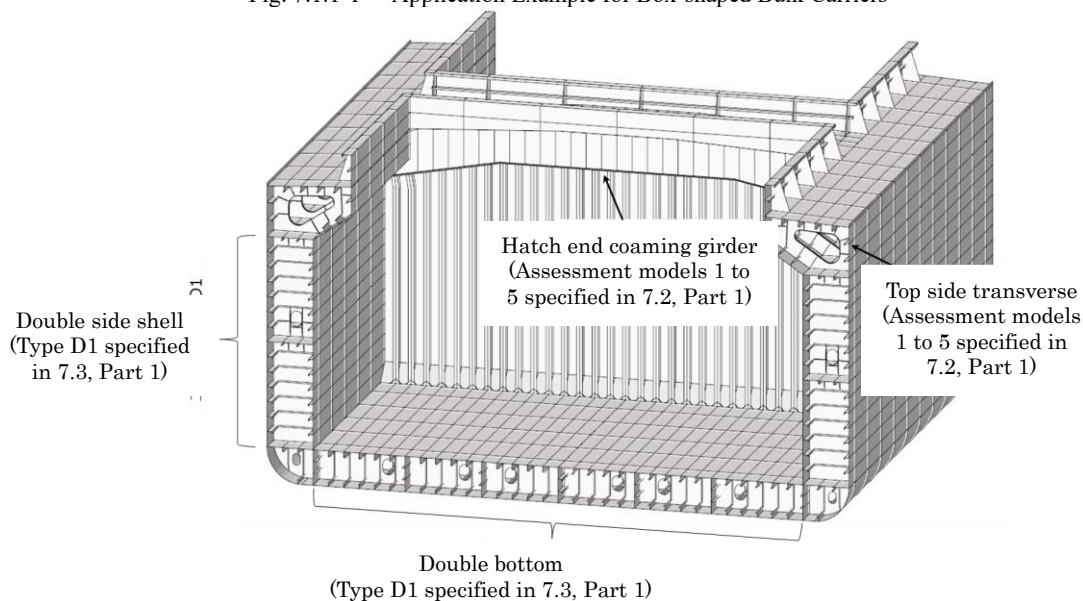

Chapter 8 STRENGTH ASSESSMENT BY CARGO HOLD ANALYSIS

8.1 General

8.1.1 Overview

8.1.1.1 Structure and Overview of this Chapter

- 1 This Chapter specifies methods for strength assessment by cargo hold analysis in box-shaped bulk carriers.
- 2 The structure and overview of this Chapter are shown in [Table 8.1.1-1](#).

Table 8.1.1-1 Overview of Chapter 8

Section	Title	Overview
8.1	General	Additional requirements related to the overview and application of this Chapter
8.2	Evaluation Area and Members to be Assessed	Additional requirements related to the evaluation area and the members to be assessed
8.3	Structural Models	Additional requirements related to the structural model
8.4	Boundary Conditions and Loads Conditions	Additional requirements related to the boundary conditions and loads conditions
8.5	Strength Assessment	Additional requirements for buckling strength assessment

8.1.2 Application

8.1.2.1 Applicable Ships

Ships that strength assessment by cargo hold analysis is required, which fall under [8.1.2.1-1\(2\), Part 1](#) are to be ships of which the length of L_C is 150 m or more.

8.2 Evaluation Area and Members to be Assessed

8.2.1 Evaluation Area

8.2.2.1 Members to be Assessed

In applying [8.2.2.1, Part 1](#), the structures and members to be assessed are to be as follows.

- (1) Double bottom structure (bottom shell, inner bottom plating, centre girder, side girder and floor)
- (2) Double side shell structure (side shell, longitudinal bulkhead, side stringer and side transverse)
- (3) Bulkhead structure
- (4) Deck structure (strength deck, cross deck, hatch coaming, etc.)
- (5) Other members deemed necessary by the Society

8.3 Structural Models

8.3.1 General

8.3.1.1 Extent of Model

In applying [8.3.1.1, Part 1](#), the model is, in principle, to represent three adjacent cargo holds with the target the middle and the full depth and the full width of the holds are to be modelled.

8.4 Boundary Conditions and Loads Conditions

8.4.1 Boundary Conditions

8.4.1.1

In applying 8.5.1, Part 1, the boundary conditions are to consist of the rigid links at model ends and point constraints (See Table 8.4.1-1).

Table 8.4.1-1 Boundary Conditions

Location and node		Translation direction			Rotation direction		
		<i>X</i> direction	<i>Y</i> direction	<i>Z</i> direction	Around the <i>X</i> axis	Around the <i>Y</i> axis	Around the <i>Z</i> axis
Aft end	Independent point	<i>NA</i>	Constraint	Constraint	Constraint	$-M_{V-end}$	$-M_{H-end}$
	Dependent point	Constraint by a rigid link					
Fore end	Independent point	Constraint	Constraint	Constraint	Constraint	$+M_{V-end}$	$+M_{V-end}$
	Dependent point	Constraint by a rigid link					
Notes:							
(1) <i>NA</i> means no constraint applied (free).							
(2) M_{V-end} , M_{H-end} : Adjustment vertical bending moment and adjustment horizontal bending moment to be taken as given in 8.4.2.2.							

Fig. 8.4.1-1 Independent Point

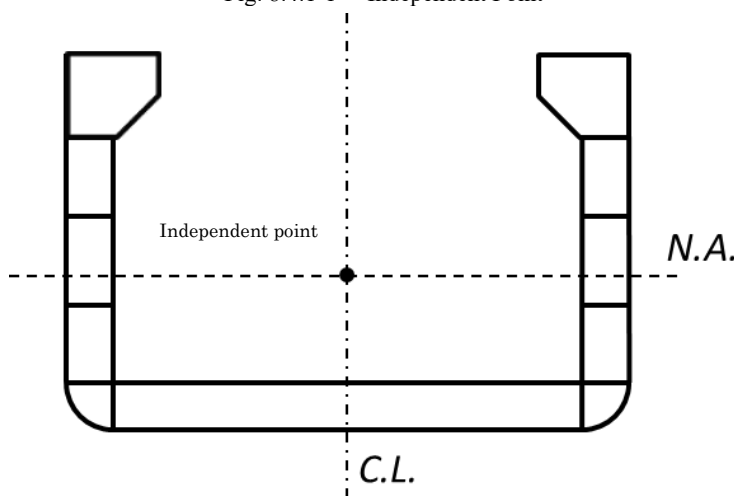

8.4.2 Load Conditions

8.4.2.1 Loads to Consider

In applying 8.5.2, Part 1, loads based also upon the additional requirements specified in 4.5 are to be considered.

8.4.2.2 Method of Applying Moments to the Structural Model

In applying 8.5.2, Part 1, the vertical bending moment and horizontal bending moment act on the target hold are to be adjusted in accordance with the following (1) to (3) based upon the boundary conditions specified in 8.4.1 and the value of the moment for each analysis case.

- (1) The maximum and minimum values of the vertical bending moment and horizontal bending moment act on the target hold due to local loads are to be calculated by the following formulae. External pressure, internal pressure, weight of the hull structure etc., are considered as the local loads.

$$M_{V-Max} = \max(M_{V-FEM}(x) | x_{th-a} \leq x \leq x_{th-f})$$

$$M_{V-Min} = \min(M_{V-FEM}(x) | x_{th-a} \leq x \leq x_{th-f})$$

$$M_{H-Max} = \max(M_{H-FEM}(x) | x_{th-a} \leq x \leq x_{th-f})$$

$$M_{H-Min} = \min(M_{H-FEM}(x) | x_{th-a} \leq x \leq x_{th-f})$$

Here,

x_{th-a} , x_{th-f} : X coordinate (m) of the aft and fore ends of the target hold

$M_{V-FEM}(x)$, $M_{H-FEM}(x)$: Vertical bending moment and horizontal bending moment ($kN-m$) due to local loads at any position x , to be taken as follows:

$$M_{V-FEM}(x) = -(x - x_{aft})R_{V-aft} - \sum_i^{x_i < x} (x - x_i)f_{vi}$$

$$M_{H-FEM}(x) = (x - x_{aft})R_{H-aft} + \sum_i (x - x_i)f_{hi}$$

x : X coordinate (m) of position x

x_{aft} , x_{fore} : X coordinate (m) of the aft and fore ends of the structural model

R_{V-fore} , R_{V-aft} , R_{H-fore} , R_{H-aft} : Vertical and horizontal reaction forces (kN) at the support points at the fore and aft ends of the model, to be taken as follows:

$$R_{V-fore} = -\frac{\sum_i (x_i - x_{aft})f_{vi}}{x_{fore} - x_{aft}}$$

$$R_{V-aft} = -\sum_i f_{vi} - R_{V-fore}$$

$$R_{H-fore} = -\frac{\sum_i (x_i - x_{aft})f_{hi}}{x_{fore} - x_{aft}}$$

$$R_{H-aft} = -\sum_i f_{hi} - R_{H-fore}$$

f_{vi} , f_{hi} : Vertical and horizontal components of the local load in the length direction of the ship x_i (kN)

x_i : X coordinate (m) of the considered longitudinal station x_i .

- (2) The adjustment vertical bending moment M_{V-end} , and adjustment horizontal bending moment M_{H-end} ($kN-m$) are obtained by the following formulae.

$$M_{V-end} = M_{V-targ} - M_{V-max}, \text{ for } M_{V-targ} \geq 0$$

$$M_{V-end} = M_{V-targ} - M_{V-min}, \text{ for } M_{V-targ} < 0$$

$$M_{H-end} = M_{H-targ} - M_{H-max}, \text{ for } M_{H-targ} \geq 0$$

$$M_{H-end} = M_{H-targ} - M_{H-min}, \text{ for } M_{H-targ} < 0$$

M_{V-targ} , M_{H-targ} : The maximum or minimum value in the target hold of the vertical bending moment and horizontal bending moment ($kN-m$) specified in [Table 8.4.2-1](#)

- (3) The adjustment moments M_{V-end} and M_{H-end} obtained from (2) above are to be applied to the independent points at the fore and aft ends of the model.

Table 8.4.2-1 M_{V-targ} and M_{H-targ}

	Maximum load condition	Harbour condition	Testing condition	Flooded condition
Vertical bending moment M_{V-targ}	M_{V-HG}	M_{PT_max} or M_{PT_min}	0	M_{FD_max} or M_{FD_min}
Horizontal bending moment M_{H-targ}	M_{H-HG}	0	0	0
Notes:				
M_{V-HG} , M_{H-HG} : Vertical bending moment and horizontal bending moment ($kN-m$) in maximum load condition.				
M_{PT_max} , M_{PT_min} : Vertical bending moment in harbour condition ($kN-m$)				
M_{FD_max} , M_{FD_min} : Still water bending moment in flooded condition ($kN-m$)				

Fig. 8.4.2-1 Example of Vertical Bending Moment Adjustment

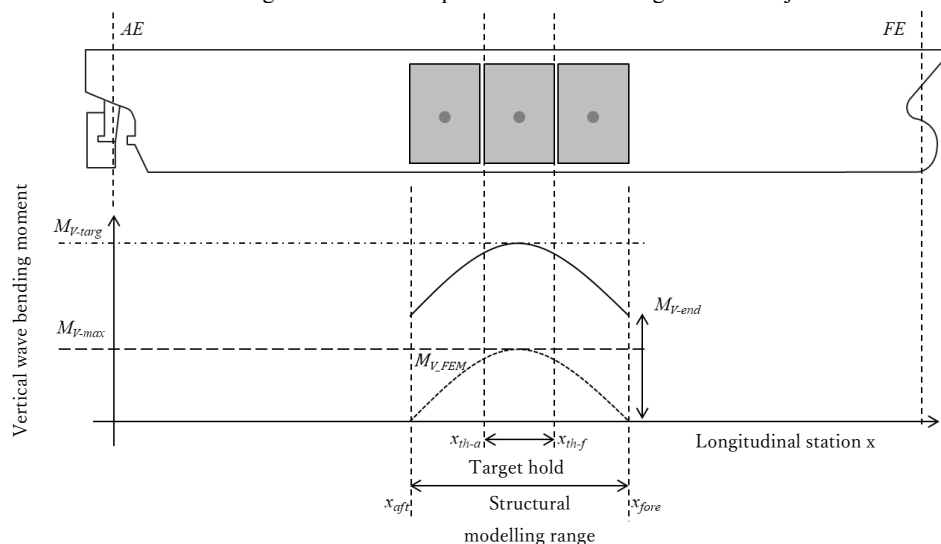

2 In cases where moments at the cross sections in the target hold exceed those to be considered as the result of applying -1 above, because of being long with the length in longitudinal direction of the target hold and/or significant gap between moments distribution to be considered and those due to local loads and the reasons other than them, the stress caused by the excess moments may be subtracted in accordance with the method as deemed appropriate by the Society. And for the same reasons and etc., where vertical shear force in the target hold exceeds the force specified in 4.3.2, Part 1, the effect due to the excess shear force may not be considered.

3 Where the foremost of aftmost cargo hold is selected as a target hold, the method of moment adjustment and boundary conditions may be applied in accordance with the relevant requirements of 8.4, Part 2-8. M_{V-end}

8.5 Strength Assessment

8.5.1 Yield Strength Assessment and Buckling Strength Assessment

8.5.1.1 Strength Assessment of Side Shell in Beam Sea

1 Where strength assessment is performed considering the load based on the equivalent design waves *BR* and *BP* in the maximum load condition, 8.6.2.1-2, Part 1 may be applied for stiffened panels of side shell instead of 8.6.2.1-1, Part 1 where the compressive stress in the shorter side direction of the panels, which is due to bending deformation of side transverse and side shell, is a dominant component (See Table 8.5.1-1).

2 In application of -1 above, yield strength assessment specified in 8.6.1, Part 1 of side shell need not be carried out.

3 In application of -1 above, where the yield strength assessment and buckling strength assessment specified in An2.7, Annex 8.6A, Part 1 “Strength Assessment Considering Effect of Surrounding Structures” are carried out, the yield strength and buckling strength assessments may not be required for the following (1) to (3).

- (1) Stiffened panels within the rigidity reduction range
- (2) Buckling panels which include elements sharing nodes included in the elements of (1) above
- (3) Elements which include (1) and (2) above

8.5.1.2 Buckling Strength Assessment of Cross Deck in Head Sea and Following Sea

Where strength assessment is performed considering the load based on the equivalent design waves *HM-1* and *FM-1* in the maximum load condition, assessment of 8.6.2.1-1, Part 1 may not be carried out for plate panel on cross deck stiffened in transverse direction when the following is satisfied (See Table 8.5.1-1).

- (1) The stress in longitudinal direction on cross deck due to vertical bending moment is act on the narrow area enough compared to the length of cross deck in transverse direction.
- (2) Thickness of cross deck adjacent to upper deck longitudinally stiffened is greater than 50 % of thickness of the upper deck.

8.5.1.3 Strength Assessments of Plane-type Transverse Bulkheads

1 Where strength assessments are performed in the maximum load condition, 8.6.2.1-2, Part 1 may be applied instead of the

assessment under compressive loads in shorter side direction specified in **8.6.2.1-1, Part 1**, for plate panels of plane-type transverse bulkheads of vertically stiffened system (See **Table 8.5.1-1**).

2 In the application of -1 above, the yield strength assessments specified in **8.6.1, Part 1** need not be carried out for the said plane-type transverse bulkheads.

3 In the application of -1 above, where the yield strength assessments and buckling strength assessments specified in **An2.7, Annex 8.6A, Part 1** “Strength Assessment Considering Effect of Surrounding Structures” are carried out, such yield strength and buckling strength assessments need not be required for the following (1) to (3).

- (1) Plate panels within the rigidity reduction range
- (2) Buckling panels which include elements sharing nodes included in the elements of (1) above
- (3) Elements which include (1) and (2) above

Table 8.5.1-1 Relationship between the Application of Part 1 and Part 2

Paragraph 2	Member to be assessed	Maximum load condition	
		Equivalent design waves <i>HM</i> and <i>FM</i>	Equivalent design waves <i>BR</i> and <i>BP</i>
8.5.1.1	Side shells within rigidity reduction ranges	<ul style="list-style-type: none"> • Yield strength assessment: As specified in 8.6.1, Part 1 • Buckling strength assessment: As specified in 8.6.2.1-1, Part 1 	<ul style="list-style-type: none"> • An2.2 to An2.6, Annex 8.6A, Part 1 apply • Permissible utilisation factor (buckling): 0.8 • Yield strength assessment: <i>NA</i>
	Other members ⁽¹⁾		<ul style="list-style-type: none"> • An2.7, Annex 8.6A, Part 1 applies • Yield strength assessment: As specified in 8.6.1, Part 1. • Buckling strength assessment: As specified in 8.6.2.1-1, Part 1
8.5.1.2	Cross decks	<ul style="list-style-type: none"> • Yield strength assessment: As specified in 8.6.1, Part 1 • Buckling strength assessment: As specified in 8.5.1.2 	<ul style="list-style-type: none"> • Yield strength assessment: As specified in 8.6.1, Part 1 • Buckling strength assessment: As specified in 8.6.2.1-1, Part 1
8.5.1.3	Plane-type transverse bulkheads within rigidity reduction ranges	<ul style="list-style-type: none"> • An2.2 to An2.6, Annex 8.6A, Part 1 apply • Permissible utilisation factor (buckling): 0.8 • Yield strength assessment: <i>NA</i> 	
	Other members ⁽¹⁾	<ul style="list-style-type: none"> • An2.7, Annex 8.6A, Part 1 applies • Yield strength assessment: As specified in 8.6.1, Part 1 • Buckling strength assessment: As specified in 8.6.2.1-1, Part 1 	
<p>(1) Where 8.5.1.1 and 8.5.1.3 are applied simultaneously for the equivalent design waves <i>BR</i> and <i>BP</i>, members within rigidity reduction ranges are excluded.</p>			

Chapter 9 FATIGUE

9.1 General

9.1.1 Application of Fatigue Requirements

9.1.1.1 Application

Ships with a length L_C of 150 m or more are to be assessed for fatigue strength based on the hot spot stresses obtained by simplified stress analysis according to **9.3, Part 1** and finite element analysis according to **9.4, Part 1**.

9.2 Structural Details to be Assessed

9.2.1 Structural Details to be Assessed by Finite Element Analysis

9.2.1.1

1 Critical structural details to be assessed for fatigue strength by finite element analysis according to **9.4, Part 1**, are shown in **Table 9.2.1-1**.

2 Notwithstanding the requirements specified in -1, where documents demonstrating sufficient fatigue strength are submitted and deemed appropriate by the Society, the fatigue strength assessment of the structure may be omitted.

Table 9.2.1-1 Structural Details of Primary Members to be Assessed in the Hull Structure

No.	Critical structural details of hull structure
1	Intersections between inner longitudinal bulkhead and inner bottom plating
2	Intersections between lower stool and inner bottom plating in way of bottom girder
3	Hatch corner
4	Intersections between inner bottom plating, bilge hopper plating, lower stool, and corrugated bulkhead
5	Other areas with large stress concentration

9.3 Loading Conditions and Fraction of Time to be Considered

9.3.1 General

9.3.1.1

1 Standard loading conditions and fraction of time are to be in accordance with **Table 9.3.1-1**.

2 Notwithstanding the requirements specified in -1, when considering loading conditions and fraction of time other than those in **Table 9.3.1-1**, it is necessary to consider appropriate combinations.

Table 9.3.1-1 Standard Loading Conditions and Fraction of Time

Loading conditions	Fraction of time $\alpha_{(j)}$
Full load condition (homogeneous loading)	25%
Full load condition (alternate loading)	25%
Ballast condition	50%

9.4 Boundary Conditions and Load Conditions

9.4.1 Boundary Conditions

9.4.1.1

In applying 9.4.4.1, Part 1, the boundary conditions are to be in accordance with 8.4.1.1.

9.4.2 Load Conditions

9.4.2.1 Method of Applying Moments to the Structural Model

In applying 9.4.4.2, Part 1, the method of applying moments to the structural model is to be in accordance with 8.4.2.2. However, the vertical bending moment and horizontal bending moment ($kN-m$) specified in Table 9.4.2-1 are to be used as M_{V-targ} and M_{H-targ} instead of those specified in Table 8.4.2-1.

Table 9.4.2-1 M_{V-targ} and M_{H-targ}

	Cyclic load condition
Vertical bending moment M_{V-targ}	M_{V-HG}
Horizontal bending moment M_{H-targ}	M_{H-HG}
Notes: M_{V-HG} , M_{H-HG} : Vertical bending moment and horizontal bending moment ($kN-m$) under cyclic load condition, to be in accordance with 4.7.2.10, Part 1.	

9.5 Detailed Design Standards

9.5.1 Connections between bilge hopper plating and inner longitudinal bulkhead

9.5.1.1

1 The stiffener provided along the weld joints between bilge hopper plating and inner longitudinal bulkhead in the aftermost cargo hold is to be in accordance with (1) or (2).

- (1) The stiffener provided at the position specified in -1 is not to penetrate to the transverse girders.
- (2) If the stiffener provided at the position specified in -1 penetrates to the transverse girders, the slots are to be eliminated or covered by collar plates.

2 Instead of -1, fatigue strength assessments by finite element analysis for hot spot stress may be performed.

Chapter 10 ADDITIONAL STRUCTURAL REQUIREMENTS

10.1 Bottom Structure

10.1.1 Double Bottoms

10.1.1.1 Struts

In case where struts are provided, the struts are to be rolled sections other than flat or burb plates and are to sufficiently overlap the webs of the bottom and inner bottom longitudinals.

10.1.1.2 Double Bottom Structure Under the Lower Stool at Transverse Bulkhead

The inner bottom plating, centre girders, side girders and inner bottom longitudinals under lower stools at transverse bulkheads are to be connected to the extensions of those of holds just before and behind the bulkheads. The floors are to be equivalent to those of holds.

10.1.2 Scuppers

10.1.2.1 General

- 1 One bilge suction pipe is to be provided, in general, on each side of the ship at the after end of each hold.
- 2 Bilge wells are to be provided at suitable positions so as to protect the cover plates from direct impact from bulk cargoes, and to be provided with mud boxes or other suitable means so that the suction openings are not choked by dust.
- 3 Where bilge pipes pass through double bottoms or bilge hopper tanks, non-return valves or stop valves capable of being closed down from a readily accessible position are to be provided at their open ends.

10.2 Side Structure

10.2.1 Bilge Hopper Tanks

10.2.1.1 Continuity of Strength

Sufficient care is to be taken for the continuity of strength at fore and after ends of bilge hopper tank structure.

10.2.1.2 Transverse webs

Where effective struts are provided at an intermediate position on transverse webs, the depth of transverse webs in the bilge hopper tanks is not to be less than 1/6 of the overall length of the transverse webs. Otherwise, the depth is not to be less than 1/5 of the overall length of the transverse webs and 2.5 times the depth of slots for penetrating the longitudinals, whichever is greater.

10.2.2 Topside Tanks

10.2.2.1 Continuity of Strength

Sufficient care is to be taken for the continuity of strength at the fore and after ends of topside tank structure.

10.2.2.2 Transverse webs

1 Where effective struts are provided at an intermediate position on transverse webs, the depth of transverse webs in the topside tanks is not to be less than 1/6 of the overall length of the transverse webs. Otherwise, the depth is not to be less than 1/5 of the overall length of the transverse webs and 2.5 times the depth of slots for penetrating the longitudinals, whichever is greater.

2 Where heavy cargoes are loaded on the deck, web plates are to be suitably reinforced.

10.2.2.3 Large Topside Tanks

1 Where topside tanks are large, special consideration is to be given to the structure such as providing longitudinal diaphragms around the mid-point of the breadth of topside tanks.

2 When longitudinal stiffeners are provided on longitudinal diaphragms, the depth of the stiffeners is not to be less than $0.06l$, where, l is the distance between the girders provided on the longitudinal diaphragms. However, where the longitudinal stiffeners are connected with the tripping brackets at the ends, the depth of the stiffener may be properly reduced.

3 When transverse stiffeners provided on longitudinal diaphragms, the thickness of the longitudinal diaphragms is to be sufficient against buckling. The depth of the stiffeners are to be equivalent to those specified in -2 above.

10.2.2.4 Scuppers

Overboard discharges from topside tanks are to be in accordance with the requirements of **13.4.1-6** and **-7, Part D**.

10.3 Bulkhead Structure**10.3.1 Transverse Bulkheads****10.3.1.1 General**

1 For transverse bulkheads without lower stools, the thickness of the lowest strake of bulkhead plating is to be appropriately increased according to the thickness of the inner bottom plating.

2 Plating of transverse bulkheads to which the sloping plates of topside tanks are connected, is to be properly strengthened by increasing its thickness or by other means.

10.3.2 Lower and Upper Stools at Transverse Bulkheads**10.3.2.1 General**

1 In lower stools at transverse bulkheads, stiffening girders are to be provided at the centre girder and side girders of the double bottoms.

2 Where the cargo holds are so designed as to be loaded with ballast water or heavy cargo, the stiffening girders in the lower stools of the transverse bulkheads are to be sufficient against shearing by taking measures such as adopting diaphragms.

3 For ships designed for loading and/or unloading in multiple ports, upper stools deemed as appropriate by the Society are to be provided on vertical corrugated type transverse bulkheads.

10.4 Deck Structure**10.4.1 Hatch End Coaming****10.4.1.1**

Hatch end coamings are to be provided in coincidence with the positions of girders in topside tanks or double side structures. If not coincident, sufficient care is to be taken for the continuity of strength at the connections of hatch end coamings with topside tanks.

10.5 Requirements for GRAB Notation**10.5.1 General****10.5.1.1 Application**

Ships affixed with the notation “*Grab*” in the classification characters are to be in accordance with **10.5**.

10.5.2 Scantlings of Inner Bottoms**10.5.2.1 Inner Bottoms**

The thickness of the inner bottom is to be not less than the value obtained from the following formula. However, this excludes bilge wells, and other points unaffected by grabbing.

$$t = C \sqrt{\frac{b}{\sigma_Y}} \text{ (mm)}$$

C : Coefficient to be taken as $0.55\sqrt{L_C}$. However, where the value of C is less than 6.8, C is to be taken as 6.8.

L_C : Length of ship (m)

σ_Y : Specified yield stress (N/mm^2)

b : Length of the shorter side of the plate panel (mm)

10.5.2.2 Bilge Hopper Plating and Longitudinal Bulkhead Plating

The thickness of bilge hopper plating and longitudinal bulkhead plating within a height of 1.5 m from the lowermost point of the inner bottom is to be not less than the value obtained from the following formula.

$$t = 0.75C \sqrt{\frac{b}{\sigma_Y}} \text{ (mm)}$$

C : As prescribed in **10.5.2.1**.

σ_Y : Specified yield stress (N/mm^2)

b : Length of the shorter side of the plate panel (mm)

10.6 Other

10.6.1 Special Requirements for Ship Transporting Coal

10.6.1.1

For ships intended for the transport of coal, care is to be taken regarding the following (1) to (3).

- (1) The structure between holds and other compartments is to be airtight.
- (2) Trimming hatches are recommended to be provided on the outside of superstructures and deckhouses.
- (3) Ventilation of holds is to be made by a ventilation system provided on the weather part.

10.6.2 Supplementary Requirements for Ballast Holds

10.6.2.1

In cases where the cargo hold is used as a ballast tank, in general, they are to be kept empty or full throughout the duration of the voyage in order to avoid impact due to the dynamic load of the ballast water.

10.6.3 Special Requirements for Ship Intended for the Carriage of Cargoes Having Moisture Contents Which Exceed Transportable Moisture Limit

10.6.3.1

The hull structural members of ships intended for the carriage of cargoes having moisture contents which exceed transportable moisture limit are to be in accordance with the requirements provided in **10.5.1, Part 2-3**.

10.6.4 Ships Loaded with Containers

10.6.4.1 Container Loading Reinforcement

Decks below container corner fittings are to be constructed (e.g. provided with girder plates) to effectively support the loads of containers.

Annex 1.1 ADDITIONAL REQUIREMENTS FOR BULK CARRIERS IN CHAPTER XII OF THE SOLAS CONVENTION

An1. General

An1.1 Application

An1.1.1

- 1 This Annex applies to bulk carriers defined in [An1.2.1\(1\)](#).
- 2 Except where required otherwise in this Annex, the requirements of [Parts 2-2, 2-3, 2-4, 2-5](#) and the general requirements for construction and equipment of steel ships, as applicable, are to be applied.
- 3 For the application of the requirements of [An2.](#), [An3.](#), [An4.](#) and [An5.](#) for bulk carriers of double-side skin construction which have a longitudinal bulkhead located within $B/5$ or 11.5 m , whichever is less, inboard from the ship's side at right angled to the centreline at the assigned summer load line, cargo holds where the longitudinal bulkhead is closer to the ship's side than the required distance are to be considered flooded.

An1.2 Definitions

An1.2.1

Terms used in this Annex are defined as follows:

- (1) *“Bulk carrier”* means a ship which is intended primarily to carry dry cargo in bulk, including such types as ore carriers and combination carriers (i.e. ships which have loading conditions for carrying dry cargoes in bulk included in their loading manual).
- (2) *“Bulk carrier of single-side skin construction”* means a bulk carrier as defined in (1), other than bulk carriers of double-side skin construction as defined in (3).
- (3) *“Bulk carrier of double-side skin construction”* means a bulk carrier as defined in (1), in which all cargo holds are bounded by a double-side skin as defined in (4).
- (4) *“Double-side skin”* means a configuration where each ship side is constructed by the side shell and a longitudinal bulkhead connecting the double bottom and the deck. Hopper side tanks and top-side tanks may, where fitted, be integral parts of the double-side skin configuration.
- (5) *“Solid bulk cargo”* means any material, other than liquid or gas, consisting of a combination of particles, granules or any larger pieces of material, generally uniform in composition, which is loaded directly into the cargo spaces of a ship without any intermediate form of containment.
- (6) *“Bulk cargo density”* or *“Bulk density”* (t/m^3) means the ratio of the loaded cargo mass to the volume which is assumed to be occupied by the loaded cargo including empty spaces within the bulk cargo, notwithstanding the specific gravity of the cargoes defined in [4.4.2.5, Part 1](#).
- (7) *“Permeability”* of a space means the ratio of the volume within the space which is assumed to be occupied by water to the total volume of the space under consideration. In this Annex, the value given in [Table An1](#) may be used as standard according to the kind of cargo. For cargoes other than those given in [Table An1](#), the values of permeability are to be at the Society's discretion.
- (8) *“Angle of repose”* means the maximum slope angle between a horizontal plane and a cone slope of free-flowing bulk cargo. In this Annex, the value given in [Table An2](#) may be used as standard according to the kind of cargo. For cargoes other than those given in [Table An2](#), the values of permeability are to be at the Society's discretion.

Table An1 Permeability

Cargo and etc.	Permeability
Iron ore	0.3
Cement	0.3
Coal	0.3
Empty space	0.95

Table An2 Angle of Repose

Cargo and etc.	Angle of repose
Iron ore	35°
Cement	25°
Coal	35°

An2. Damage Stability**An2.1 Survivability****An2.1.1**

1 Bulk carriers, coming under the following (1) or (2), of not less than 150 m in length L_f , designed to carry solid bulk cargoes having a density of not less than 1.0 ton/m³ are to, when loaded to the summer load line, be able to withstand flooding of any one cargo hold in all loading conditions and remain afloat in a satisfactory condition of equilibrium, as specified in the following -2. However where deemed necessary by the Society, plural cargo holds are to be assumed to be flooded.

- (1) Bulk carriers of single-side skin construction
- (2) Bulk carriers of double-side skin construction in which any part of a longitudinal bulkhead is located within $B/5$ or 11.5 m, whichever is less, inboard from the ship's side at right angles to the centreline at the assigned summer load line

2 The condition of equilibrium after flooding is to be in accordance with the following:

- (1) The final water line after flooding, taking into account sinking, heel, and trim, is to be below the lower edge of any opening through which progressive flooding may take place. Such openings are to include air pipes, ventilators and openings which are closed by means of weathertight doors or hatch covers. The openings closed by means of manhole hatch covers and flush scuttles, watertight hatch covers, remotely operated sliding watertight doors, hinged watertight access doors with open/closed indication locally and at the navigation bridge of the quick-acting or single-action type that are normally closed at sea, hinged watertight doors that are permanently closed at sea, and side scuttles of the non-opening type, may be excluded.
- (2) Where pipes, ducts or tunnels are situated within the assumed extent of damage penetration, arrangements are to be made so that progressive flooding does not extend to compartments other than those assumed to be flooded.
- (3) The metacentric height in the flooded condition is to be positive.
- (4) The righting lever curve is to have a minimum range of 20 degrees beyond the position of equilibrium and a maximum righting lever of at least 0.1 m within this range. The area under the righting lever curve within this range is to be not less than 0.0175 m-rad. Unprotected openings are not to be immersed within this range except where the corresponding compartments are assumed to be flooded. "Unprotected openings" include ventilators provided with weathertight closing appliances in accordance with the requirements of 14.12.3.1-3 that for operational reasons have to remain open to supply air to the engine room or emergency generator room (if the same is considered buoyant in the stability calculation or protecting openings leading below) for the effective operation of the ship.

3 With respect to the requirements of -1 above, if the following load conditions satisfy the requirements regarding the final water line specified in -2 above, there is no need to confirm the survivability of each load condition separately.

- (1) The ship is to be loaded to its summer load water line on an even keel.
- (2) Where the vertical centre of gravity is calculated, the following conditions are to be satisfied.
 - (a) Homogeneous cargo loading condition
 - (b) All cargo compartments including those to be partly loaded are considered fully loaded.
 - (c) If the ship is intended to operate at its summer load line with empty compartments, such compartments are to be considered empty only when the height of the centre of gravity so calculated is not less than as calculated in (b) above.
 - (d) 50 % of the individual total capacity of all tanks and spaces fitted to contain consumable liquids and stores is allowed for. It is assumed that for each type of liquid, at least one transverse pair or single centre line tank has maximum free surface, and that the effect of the free surface on the tank or combination of tanks to be taken into account is the greatest. The remaining tanks are assumed either completely empty or completely filled, and the distribution of consumable liquids between these tanks is to be effected so as to obtain the greatest possible height above the keel for the centre of gravity.

(e) The specific gravity of the liquid weight is to be obtained from **Table An3**.

4 The ships whose assigned freeboards are of “B-60” or “B-100” type specified in **Part V** are to be treated as complying with -1 and -3 above.

Table An3 Specific Gravity

Liquid	Specific gravity
Sea water	1.025
Fresh water	1.000
Heavy oil C	0.950
Heavy oil A	0.900
Lubricating oil	0.900

An2.2 Permeability

An2.2.1

The permeability of the compartment assumed to be damaged is to be obtained from **Table An4**. However, the permeability may be different where deemed appropriate by the Society.

Table An4 Permeability

Compartment	Permeability
Loaded hold	0.9
Empty hold	0.95

An3. Transverse Watertight Bulkheads in Cargo Holds

An3.1 General

An3.1.1

1 The requirements in **An3** apply to vertically corrugated watertight bulkheads in cargo holds of bulk carriers, coming under the following (1) or (2), of not less than 150 m in length L_f , designed to carry solid bulk cargoes having a density of not less than 1.0 t/m³.

- (1) Bulk carriers of single-side skin construction
- (2) Bulk carriers of double-side skin construction in which any part of a longitudinal bulkhead is located within $B/5$ or 11.5 m, whichever is less, inboard from the ship’s side at right angles to the centreline at the assigned summer load line

2 In **An3**., “homogeneous loading condition” means a loading condition in which the ratio between the highest and lowest filling ratio, evaluated for each hold, does not exceed 1.20, to be corrected for different cargo densities.

3 The most severe combinations of cargo induced loads and flooding loads are to be used for examining the scantlings of the bulkheads, depending on the following loading conditions included in the loading manual: In any case, the pressure due to the flood water alone needs to be considered when making calculations. Non-homogeneous loading conditions associated with multipoint loading and unloading operations that occur before a homogeneous loading condition is reached does not need to be considered.

- (1) Homogeneous loading conditions
- (2) Non-homogeneous loading conditions

4 In applying the requirements of **An3**., holds carrying bound cargoes such as steel mill products are to be considered as empty holds for examining the scantlings of the bulkhead.

5 The thickness of bulkheads excluding the corrosion margin (hereinafter referred to as “net thickness”), t_{net} , is to be used for examining the scantlings of the bulkhead. The actual scantlings of the bulkhead are to be at least t_{net} plus the corrosion margin which is not less than 3.5 mm.

6 Unless the ship is intended to carry, in non-homogeneous conditions, only iron ore or cargo having a bulk density not less than 1.78 t/m³, the maximum mass of cargo which may be carried in the hold is to be considered as cargo that fills the hold up to the upper deck level at the centre line.

7 For ships of not less than 190 m in length L_C , bulkheads are to be fitted with a lower stool and generally with an upper stool.

For ships other than the above, corrugations may extend from the inner bottom to the deck.

An3.2 Load Conditions

An3.2.1

The flooding head z_F (m) is to be the vertical distance from the baseline in the absence of trim, according to [Table An5](#).

Table An5 Flooding Head z_F (m) of Vertically Corrugated Watertight Bulkhead

Type of bulk carrier	Loading condition	Position of the vertically corrugated watertight bulkhead	
		The aft bulkhead in the foremost cargo hold	Other bulkheads
General	Where the ship is to carry cargoes having a bulk density of less than 1.78 t/m^3 in non-homogeneous conditions	$z_F = 0.95D$	$z_F = 0.85D$
	Elsewhere	$z_F = D$	$z_F = 0.9D$
For ships less than 50,000 tonnes deadweight with a type B freeboard	Where the ship is to carry cargoes having a bulk density of less than 1.78 t/m^3 in non-homogeneous conditions	$z_F = 0.9D$	$z_F = 0.8D$
	Elsewhere	$z_F = 0.95D$	$z_F = 0.85D$

2 In a non-flooded hold loaded with cargo, the pressure P_{bs} (kN/m^2) and force F_{bs} (kN) acting on the corrugated bulkhead are to be obtained from [Table An6](#).

Table An6 Pressure P_{bs} and Force F_{bs} Acting on Corrugated Bulkheads Due to Bulk Cargo

The pressure P_{bs} (kN/m^2) at each point of the bulkhead	$P_{bs} = \rho_c g K_{c-f} (z_C - z)$
The force F_{bs} (kN) acting on the corrugated bulkhead	$F_{bs} = \rho_c g S_1 \frac{(z_C - h_{DB} - h_{LS})^2}{2} K_{c-f}$
Notes: ρ_c : Bulk cargo density (t/m^3) K_{c-f} : Coefficient, as given by the following formula: $K_{c-f} = \tan^2 \left(45^\circ - \frac{\psi}{2} \right)$ ψ : As specified in Table An2 . z_C : Distance (m) from the baseline to the horizontal plane corresponding to the top of the cargo when levelled out (See Fig. An1) h_{DB} : Height (m) of the double bottom S_1 : Spacing (m) of corrugation h_{LS} : Height (m) of the lower stool from the inner bottom plating	

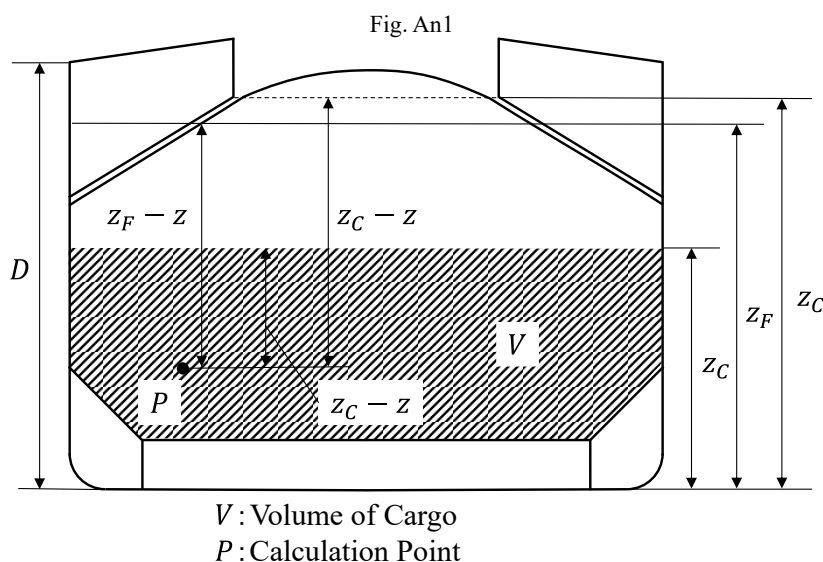

3 The pressure and force acting on the corrugated bulkhead in a cargo hold containing bulk cargo under flooded conditions are to take the following two differing flooding patterns (1) and (2) into account based on the relation between the flooding head z_F of the cargo hold and the height of the cargo z_C in each cargo hold. The static load acting on a vertically corrugated watertight bulkhead under flooded conditions P_{bf-s} (kN/m^2) and the force acting on the corrugated structure of a transverse bulkhead F_{bf-s} (kN) are to be in accordance with Tables An7 and An8, respectively.

- (1) State where the flooding head is below that of the upper surface of the cargo ($z_C > z_F$)
- (2) State where the flooding head is above that of the upper surface of the cargo ($z_C \leq z_F$)

Table An7 Static Load P_{bf-s} Acting on Vertically Corrugated Watertight Bulkhead in Cargo Hold under Flooded Conditions

Flooding pattern	Position of load point	static pressure $P_{bf-s}(kN/m^2)$
$z_F < z_C$	$z > z_C$	$P_{bf-s} = 0$
	$z_C \geq z \geq z_F$	$P_{bf-s} = \rho_c g(z_C - z)K_{c-f}$
	$z_F > z \geq h_{DB}$	$P_{bf-s} = \rho g(z_F - z) + [\rho_c(z_C - z) - \rho(1 - perm)(z_F - z)]gK_{c-f}$
$z_F \geq z_C$	$z > z_F$	$P_{bf-s} = 0$
	$z_F \geq z \geq z_C$	$P_{bf-s} = \rho g(z_F - z)$
	$z_C > z \geq h_{DB}$	$P_{bf-s} = \rho g(z_F - z) + [\rho_c - \rho(1 - perm)]g(z_C - z)K_{c-f}$

Notes:

z_F : As specified in Table An5.

$z_C, h_{DB}, \rho_c, K_{c-f}$: As specified in Table An6.

$perm$: As specified in An1.2.1 (7).

Table An8 Force F_{bf-s} Acting on Vertically Corrugated Watertight Bulkhead in Cargo Hold under Flooded Conditions

Flooding case	Force F_{bf-s} (kN)
$z_F < z_C$	$F_{bf-s} = S_1 \left[\rho_C g \frac{(z_C - z_F)^2}{2} K_{c-f} + \frac{\rho_C g (z_C - z_F) K_{c-f} + P_{bf-s-LE}}{2} (z_F - h_{DB} - h_{LS}) \right]$
$z_F \geq z_C$	$F_{bf-s} = S_1 \left[\rho g \frac{(z_F - z_C)^2}{2} + \frac{\rho g (z_F - z_C) + P_{bf-s-LE}}{2} (z_C - h_{DB} - h_{LS}) \right]$
Notes:	
z_F : As specified in Table An5 .	
$z_C, h_{DB}, \rho_C, K_{c-f}, h_{LS}, S_1$: As specified in Table An6 .	
$P_{bf-s-LE}$: In case of $z = h_{LS} + h_{DB}$, the static load (kN/m ²) calculated according to Table An7	

4 The pressure P_f (kN/m²) and force F_f (kN) acting on a corrugated bulkhead of an empty cargo hold are to be obtained from [Table An9](#).

 Table An9 Pressure P_f and Force F_f Acting on Empty Corrugated Bulkhead When Flooded

The pressure P_f (kN/m ²) at each point of the bulkhead	$P_f = \rho g (z_F - z)$
The force F_f (kN) acting on the corrugated bulkhead	$F_f = S_1 \rho g \frac{(z_F - h_{DB} - h_{LS})^2}{2}$
Notes:	
z_F : As specified in Table An5 .	
z_C, h_{DB}, h_{LS}, S_1 : As specified in Table An6 .	

5 The total pressure P_R (kN/m²) acting on each point of the bulkhead and the resultant force F_R (kN) acting on the corrugated structure as specified in [Table An10](#) are to be used as the total pressure and resultant force acting on the vertically corrugated watertight bulkhead under flooded conditions.

 Table An10 Total Pressure P_R and Resultant Force F_R Acting on Vertically Corrugated Watertight Bulkhead under Flooded Conditions

Loading condition	Total pressure P_R (kN/m ²)	Resultant force F_R (kN)
Homogeneous loading condition	$P_R = P_{bf-s} - 0.8P_{bs}$	$F_R = F_{bf-s} - 0.8F_{bs}$
Non-homogeneous loading condition	$P_R = P_{bf-s}$	$F_R = F_{bf-s}$
Notes:		
P_{bf-s} : As specified in Table An7 .		
P_{bs} : As specified in Table An6 .		
F_{bf-s} : As specified in Table An8 .		
F_{bs} : As specified in Table An6 .		

An3.3 Bending Moment and Shear Force in Bulkhead Corrugations

An3.3.1

1 The design bending moment M for bulkhead corrugations is given by the following:

$$M = \frac{F_R \ell}{8} \quad (\text{kN-m})$$

F_R : As specified in [An3.2.1-5](#)

ℓ : Span (m) of the corrugation as shown in [Figs. An2\(a\)](#) and [An2\(b\)](#)

2 The shear force Q at the lower end of the bulkhead corrugations is given by the following:

$$Q = 0.8F_R \text{ (kN)}$$

F_R : As specified in [An3.2.1-5](#)

An3.4 Strength Criteria

An3.4.1

1 The section modulus at the lower end of the corrugation is to be calculated with the following considerations.

- (1) The width of the compressive corrugation flange to be used for the calculation of the section modulus is not to exceed the effective width B_{ef} (m) obtained by the following.

$$B_{ef} = C_e a \text{ (m)}$$

$$C_e : \frac{2.25}{\beta} - \frac{1.25}{\beta^2} \quad (\beta > 1.25)$$

$$1.0 \quad (\beta \leq 1.25)$$

$$\beta : \frac{a}{t_f} \sqrt{\frac{\sigma_F}{E}} \times 10^3$$

t_f : Net flange thickness (mm)

a : Width (m) of corrugation flange (See [Fig. An2 \(a\)](#))

σ_F : Yield stress (N/mm²) of the material

- (2) Where the webs of corrugation are not supported by local brackets below the stool top (or below the inner bottom) in the lower part, the section modulus of the corrugations is to be calculated considering the corrugation webs to be 30% effective.
- (3) Provided that effective shedder plates as defined in [An3.5.1-5](#) are fitted (See Figs. [Fig. An3\(a\)](#) and [An3\(b\)](#)), the area of flange plates may be increased by the following formula when calculating the section modulus of corrugations (See cross-section (1) in Figs. [An3\(a\)](#) and [An3\(b\)](#)), but it is not to be greater than $2.5at_f$.

$$2.5a\sqrt{t_f t_{sh}} \text{ (cm}^2\text{)}$$

a : Width (m) of corrugation flange (See [Fig. An2 \(a\)](#))

t_{sh} : Net shedder plate thickness (mm)

t_f : Net corrugation flange thickness (mm)

- (4) Provided that effective gusset plates as defined in [An3.5.1-6](#) are fitted (See Figs. [An4\(a\)](#) and [An4\(b\)](#)), the area of flange plates may be increased by the following formula when calculating the section modulus of corrugations (See cross-section (1) in Figs. [An4\(a\)](#) and [An4\(b\)](#)).

$$7h_g t_f \text{ (cm}^2\text{)}$$

h_g : Height of gusset plate (m), but not to be greater than $10S_{gu}/7$ (See Figs. [An4\(a\)](#) and [An4\(b\)](#))

S_{gu} : Width of gusset plate (m)

t_f : Net flange thickness (mm)

- (5) If the corrugation webs are welded to sloping stool top plates which have an angle of not less than 45° with the horizontal plane (See [Fig. An4\(b\)](#)), the section modulus of the corrugations may be calculated taking the corrugation webs as fully effective. For angles less than 45°, the effectiveness of the web may be obtained by linear interpolation between 30% (for 0°) and 100% (for 45°). Where effective gusset plates are fitted, the area of flange plates may be increased as specified in (4) above when calculating the section modulus of corrugations. This is not applicable if only shedder plates are fitted.

- 2 Provided that effective gusset plates or shedder plates as defined in [An3.5.1-5](#), and [An3.5.1-6](#) are fitted, the section modulus of corrugations at the lower end Z'_{le} is to be not greater than Z'_{le} obtained from the following formula:

$$Z'_{le} = Z_g + \frac{Qh_g - 0.5h_g^2 S_1 P_g}{\sigma_a} \times 10^3 \text{ (cm}^3\text{)}$$

Z_g : Section modulus (cm³) of corrugation according to -3 in way of the upper end of shedder plates or gusset plates

Q : Shear force (kN) as specified in [An3.3.1-2](#).

h_g : Height (m) of shedder plates or gusset plates (See Figs. [An3\(a\)](#), [An3\(b\)](#), [An4\(a\)](#) and [An4\(b\)](#))

S_1 : As given in [An3.2.1-2](#)

P_g : Resultant pressure (kN/m²) as specified in [An3.2.1-5](#), calculated in way of the middle of the shedder plates or gusset plates

σ_a : Yield stress (N/mm²) of the material to be used for the lower end of corrugations

- 3 The section modulus of corrugations at a cross-section other than the lower end Z_m calculated in 1 and 2 is to be calculated with the corrugation webs considered effective and the compressive flange having an effective flange width b_{ef} not greater than as

given in -1 above.

- 4 The bending capacity of corrugation is to be in accordance with the following:

$$\frac{M}{0.5Z_{le}\sigma_{a,le} + Z_m\sigma_{a,m}} \times 10^3 \leq 0.95$$

M : Bending moment ($kN\cdot m$) as specified in **An3.3.1-1**

Z_{le} : Section modulus (cm^3) of corrugation at the lower end as specified in -1 above

Z_m : Section modulus (cm^3) of corrugation at the mid-span of corrugation as specified in -3 above. Z_m is not to be greater than $1.15 \cdot Z_{le}$.

$\sigma_{a,le}$: Yield stress (N/mm^2) of the material to be used for the lower end of corrugations

$\sigma_{a,m}$: Yield stress (N/mm^2) of the material to be used for the mid-span of corrugations

- 5 Shearing stress of corrugation is to be in accordance with the following: (See **Fig. An2(a)**)

$$\tau_a \geq \frac{Q \times 10^3}{A_w \sin \phi} \quad (N/mm^2)$$

$$\tau_a: 0.5\sigma_F \quad (N/mm^2)$$

σ_F : Yield stress of material (N/mm^2)

Q : Shear force (kN) as specified in **An3.3.1-2**

A_w : Sectional area (mm^2) of corrugation web at the lower end

ϕ : Angle ($^\circ$) between the web and the flange

- 6 The buckling strength of the corrugation is to fulfil the following formula so that the shearing stress τ_c for the web plates at the ends do not exceed the critical value.

$$\tau_E \leq \frac{\tau_F}{2}: \quad \tau_c = \tau_E \quad (N/mm^2)$$

$$\tau_E > \frac{\tau_F}{2}: \quad \tau_c = \tau_E \left(1 - \frac{\tau_F}{4\tau_E}\right) \quad (N/mm^2)$$

$$\tau_F: \frac{\sigma_F}{\sqrt{3}}$$

σ_F : Yield stress of material (N/mm^2)

$$\tau_E: 0.9k_t E \left(\frac{t}{1000c}\right)^2 \quad (N/mm^2)$$

k_t : Coefficient as 6.34

t : Net thickness (mm) of corrugation web

c : Width (m) of corrugation web (See **Fig. An2(a)**)

- 7 The corrugation local net plate thickness t is to comply with the following:

$$t = 14.9S_w \sqrt{\frac{1.05P}{\sigma_F}} \quad (mm)$$

S_w : Plate width (m) to be taken equal to the width of the corrugation flange or web, whichever is the greater (See **An2(a)**)

P : Resultant pressure (kN/m^2) at the bottom of each strake of bulkhead plating calculated in **An3 2.1-5**; in all cases, the net thickness of the lowest strake is to be determined using the resultant pressure at the top of the lower stool, or at the inner bottom if no lower stool is fitted, or at the top of shedders if shedder or gusset/shedder plates are fitted.

σ_F : Yield stress of material (N/mm^2)

For built-up corrugation bulkheads, of which the thickness of the flange and web are different, the thickness of the narrower plating is to be not less than t_n given by the following:

$$t_n = 14.9S_n \sqrt{\frac{1.05P}{\sigma_F}} \quad (mm)$$

S_n : Width (m) of the narrower plating

The net thickness of the wider plating t_w is to be taken not less than t_{w1} and t_{w2} obtained from following formula:

$$t_{w1} = 14.9S_w \sqrt{\frac{1.05P}{\sigma_F}} \quad (mm)$$

$$t_{w2} = \sqrt{\frac{440S_w^2 \times 1.05P}{\sigma_F} - t_{np}^2} \quad (mm)$$

t_{np} : The value (mm) not greater than the net thickness of the narrower plating and t_{w1}

An3.5 Structural Details**An3.5.1**

1 The corrugation angle ϕ shown in **Fig. An2(a)** is not to be less than 55°

2 The thickness of the lower part of the corrugations calculated in **An3.4.1-1, -2, -4 and -5** are to be maintained for a distance of not less than $0.15l$ from the inner bottom (if no lower stool is fitted) or the top of the lower stool.

3 The thickness of the middle part of the corrugations calculated in **An3.4.1-3, -4 and -5** are to be maintained for a distance of not less than $0.3l$ from the deck (if no upper stool is fitted) or the bottom of the upper stool.

4 The section modulus of the corrugation in the upper part of the bulkhead other than those specified in **-2 and -3** above is not to be less than 75% of that required for the middle part in **-3** above, and to be corrected for the yield stresses of different materials.

5 Where shedder plates are fitted, they are to comply with the following so as to maintain their effectiveness.

- (1) Not be knuckled
- (2) Be welded to the corrugation and the top plate of the lower stool by one-side penetration welds or equivalent
- (3) Have a min. slope of 45° and their lower edge is to be in line with the stool side plating
- (4) Have a thickness of not less than 75% of that of the corrugation flange, and have material properties at least equivalent to those used for the corrugation flanges

6 Where gusset plates are fitted, they are to comply with the following so as to maintain their effectiveness

- (1) Be in combination with the shedder plates of **-5** above.
- (2) Have a height of not less than half of the corrugation flange width
- (3) Be fitted in line with the stool side plating
- (4) Have a thickness and material properties at least equivalent to those used for the corrugation flanges
- (5) Be welded to the top of the lower stool by either full penetration or deep penetration welds (*See Fig. An6*) and to the corrugations and shedder plates by one side penetration welds or equivalent.

7 Where lower stools are fitted with the bulkheads, the structure and arrangements are to be in accordance with the following. For ships less than 190 m in length L_C , the following **(1)** and **(6)** are standard.

- (1) The height of the lower stool is generally to be not less than three times the depth of the corrugations.
- (2) The thickness and material of the lower stool top plate is not to be less than those required for the bulkhead plating at the lower end of the corrugation in **An3.4.1**. In addition, the type of steel in use is to be at least equivalent to that used for the bulkhead plating at the lower end of the corrugation.
- (3) The thickness and material of the upper part of the slant stool side plating with a depth equal to the corrugation flange width from the stool top is not to be less than those required for the bulkhead plating at the lower end of the corrugation stipulated in **An3.4.1**. In addition, the type of steel in use is to be at least equivalent to that used for the bulkhead plating at the lower end of the corrugation.
- (4) The ends of stool side vertical stiffeners are to be attached to brackets at the upper and lower ends of the stool.
- (5) The distance from the edge of the stool top plate to the surface of the corrugation flange is to be not less than the thickness of the flange (*See Fig. An5*).
- (6) The stool bottom is to be installed in line with double bottom floors and is to have a width of not less than 2.5 times the mean depth of the corrugation.
- (7) The stool is to be fitted with diaphragms in line with the longitudinal double bottom girders for effective support of the corrugated bulkhead.
- (8) Scallops in the brackets and diaphragms in way of the connections to the stool top plate are to be avoided.
- (9) Flanges and webs of corrugated bulkhead plating are to be connected to the stool top plate by full penetration welds. The stool side plating is to be connected to the stool top plate and the inner bottom plating by either full penetration or deep penetration welds (*See Fig. An6*).

8 Where upper stools are fitted with the bulkheads, the structure and arrangements are to be in accordance with the following. For ships less than 190 m in length L_C , the following **(1)** and **(4)** are standard.

- (1) The upper stool, where fitted, is to have a height generally between two to three times the depth of corrugations. When measured at the hatch side girder, the height of rectangular stools from the deck is to be generally equal to two times the depth of corrugations.

- (2) The upper stool is to be properly supported by girders or deep brackets between the adjacent hatch-end beams.
- (3) The width of the stool bottom plate is generally to be the same as that of the lower stool top plate.
- (4) The stool top of non-rectangular stools is to have a width of not less than two times the depth of corrugations.
- (5) The thickness and material of the stool bottom plate are to be the same as those of the bulkhead plating below.
- (6) The thickness of the lower portion of stool side plating is not to be less than 80% of that required for the upper part of the bulkhead plating where the same material is used.
- (7) The ends of stool side vertical stiffeners are to be attached to brackets at the upper and lower ends of the stool.
- (8) Diaphragms are to be fitted inside the stool in line with and effectively attached to longitudinal deck girders extending to the hatch end coaming girders for effective support of the corrugated bulkhead.
- (9) Scallops in the brackets and diaphragms in way of the connection to the stool bottom plate are to be avoided.

9 Where upper stools are fitted with the bulkheads, the structure and arrangements are to be in accordance with the following.

- (1) Where no upper stools are fitted, two transverse reinforced beams are to be fitted in line with the corrugation flanges at the deck. The thickness and material of the beams are not to be less than those required for the bulkhead plating at the upper end of the corrugation, and the height of the beams are to be generally not less than half the depth of the corrugations.
- (2) Where no lower stools are fitted, the corrugation flanges are to be in line with the supporting floors. Flanges and webs of corrugated bulkhead plating are to be connected to the inner bottom plating by full penetration welds. The plating of supporting floors is to be connected to the inner bottom by either full penetration or deep penetration welds (*See Fig. An6*). The thickness and material properties of the supporting floors are to be at least equal to those of the corrugation flanges.
- (3) The scallops for connections of the inner bottom longitudinals to the double bottom floors in (2) above are to be closed by collar plates. The supporting floors are to be connected to each other by suitably designed shear plates, as deemed appropriate by the Society.

10 The design of local details is to be for the purpose of transferring the force and moment acting on the corrugation to boundary structures, in particular to the double bottom and cross-deck structures.

Fig. An2

(a)

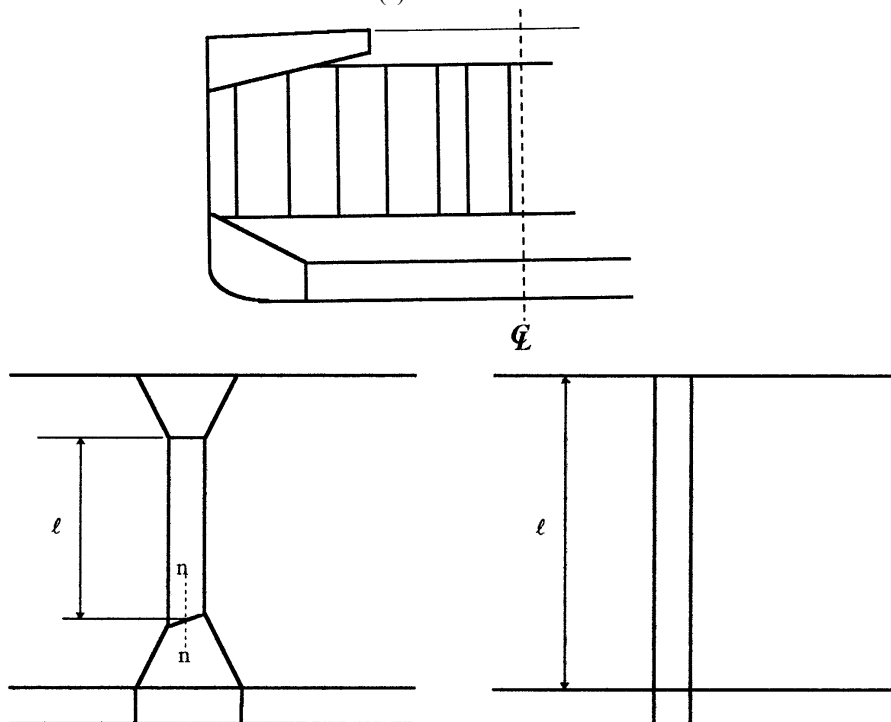

n = Neutral Axis of the corrugations

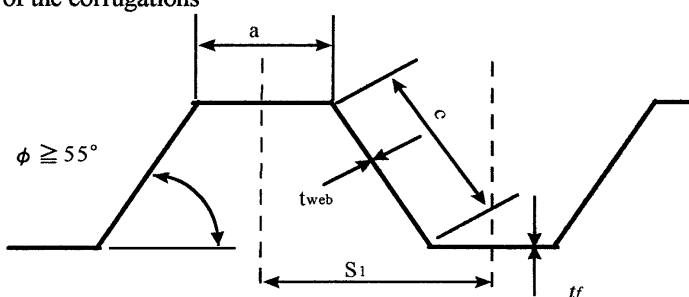

(b)

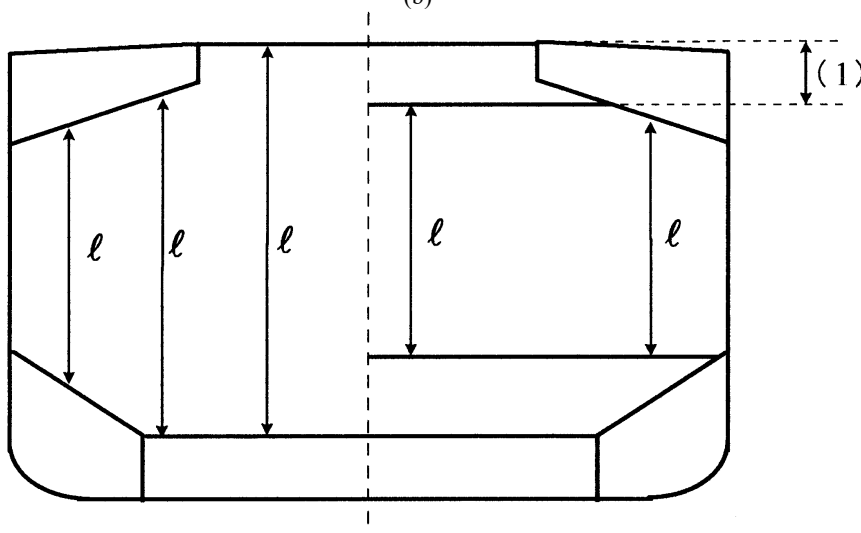

ℓ : Span of the corrugation

Where the upper stool is provided, the upper end of " ℓ " may be the bottom of the upper stool. However, the distance between the upper end of " ℓ " and the upper deck at the centre line (1) is not to be greater than the following values;

- (a) 3 times the depth of corrugations, in general
- (b) 2 times the depth of corrugations, for rectangular stool

Fig. An3

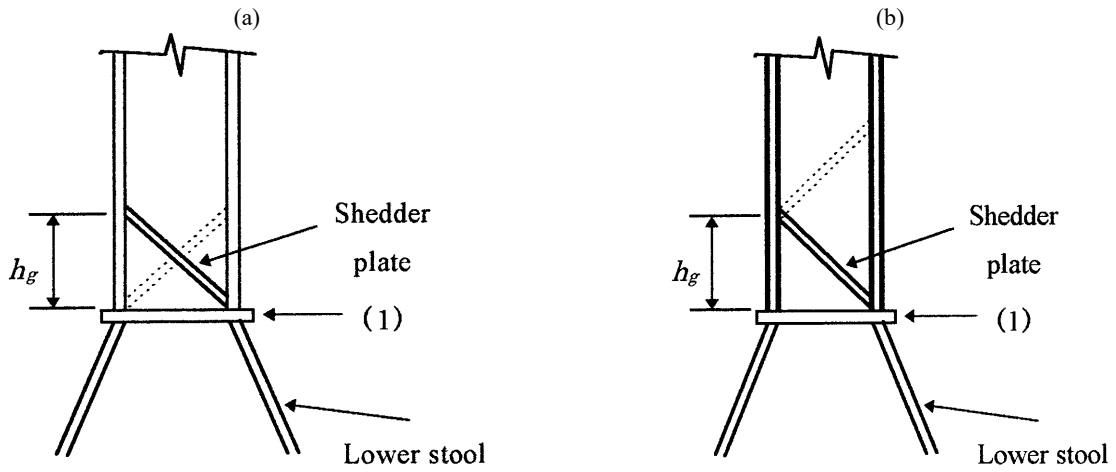
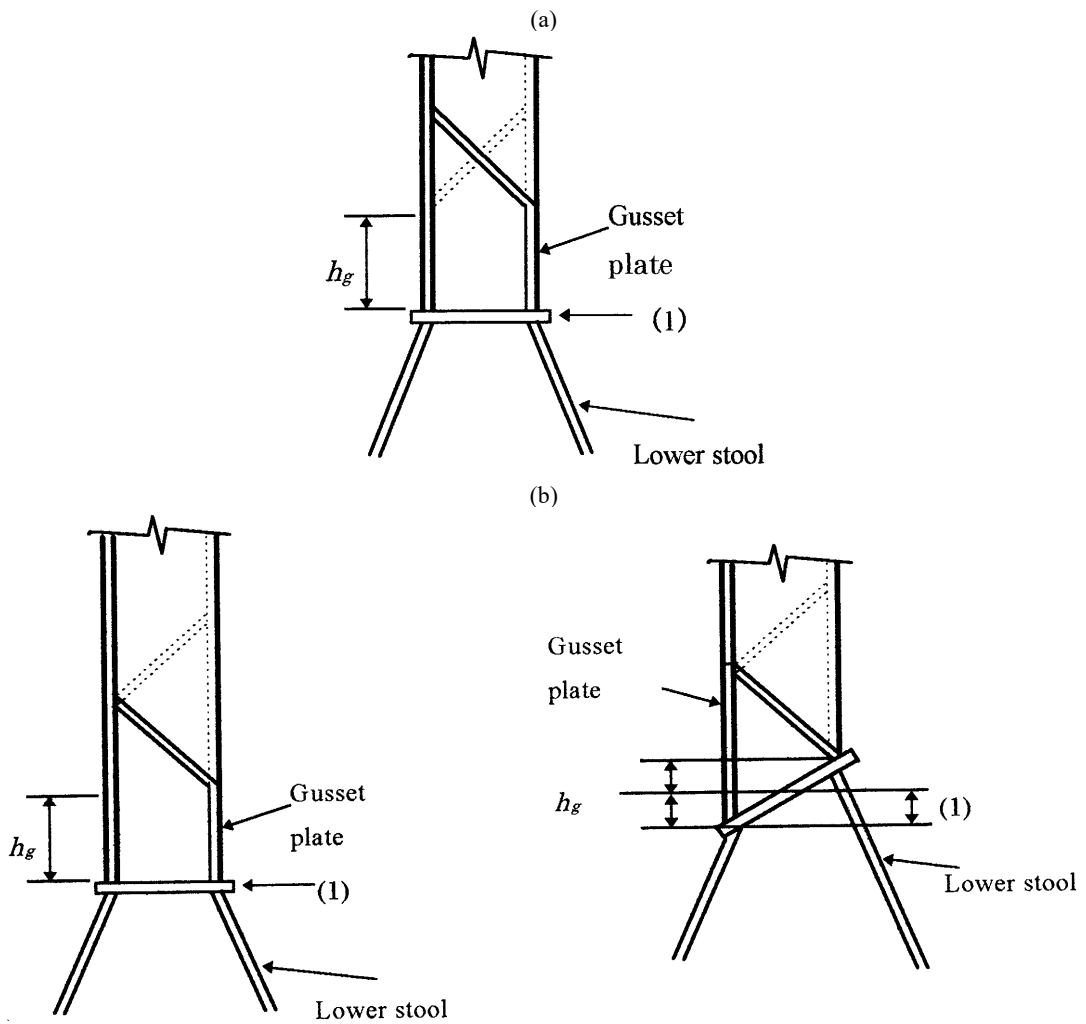
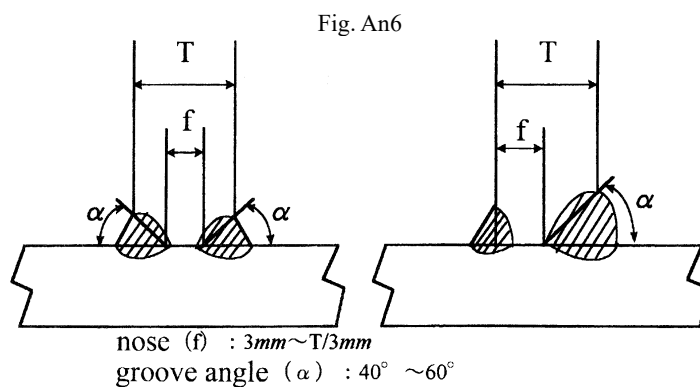
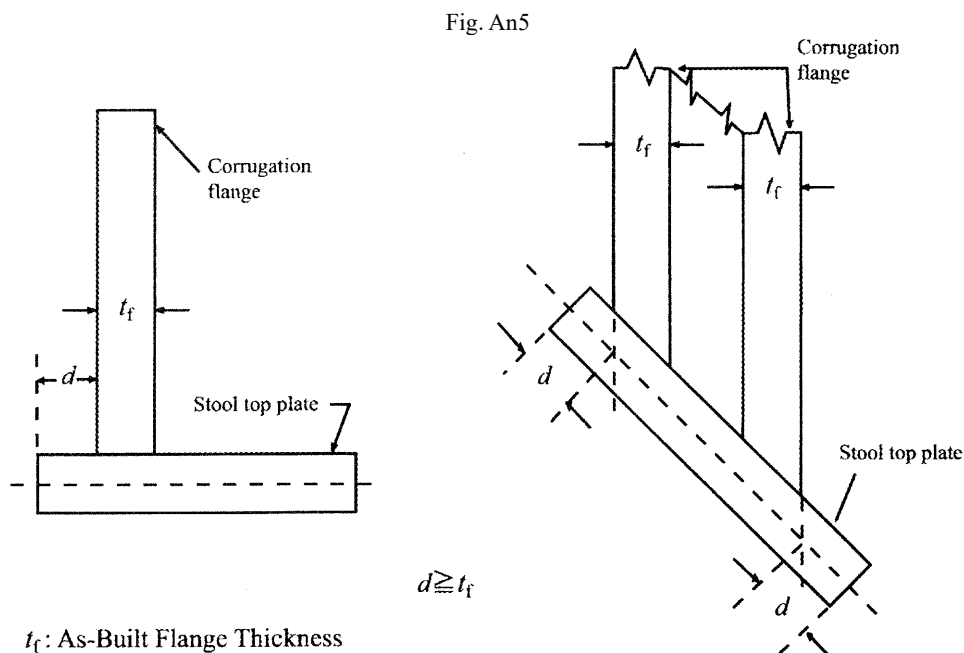

Fig. An4





An3.6 Renewal Thickness for Ship in Operation

An3.6.1

Structural drawings of corrugated bulkheads complying with the requirements of [An3.4.1](#) are to indicate the renewal thickness ($t_{as-built}$) for each structural element, given by the following formula in addition to the as built thickness ($t_{renewal}$). If the thickness for voluntary addition is included in the as built thicknesses, the value may be at the discretion of the Society.

$$t_{renewal} = t_{as-built} - 3.0 \text{ (mm)}$$

An4. Allowable Hold Loading on Double Bottom

An4.1 General

An4.1.1

1 Bulk carriers, coming under the following (1) or (2), of not less than 150 m in length L_f , designed to carry solid bulk cargoes having a density of not less than 1.0 ton/m³ are to have sufficient double bottom strength to withstand flooding of any one cargo hold in all designed loading and ballast conditions. Evaluation of the double bottom strength is to be in accordance with [An4.3](#).

- (1) Bulk carriers of single-side skin construction
- (2) Bulk carriers of double-side skin construction in which any part of a longitudinal bulkhead is located within $B/5$ or 11.5 m, whichever is less, inboard from the ship's side at right angles to the centreline at the assigned summer load line

2 Applicability for ships without bilge hopper tanks are to be in accordance with the following.

- (1) For ships having double side construction from the tank top to the upper deck, e.g. box shape ships, the parts of double side construction are to be treated as bilge hoppers.

- (2) For ships having single side construction from the tank top to the upper deck or top side tanks, ends of the lower brackets of the web frames are to be treated as the lower ends of hoppers.

An4.2 Notes for Evaluation of Strength

An4.2.1

1 The maximum bulk cargo density is of importance when considering the cargo load acting on the double bottom of a cargo hold that is flooded.

- 2 In calculating the shear strength, the net thickness t_{net} of floors and girders is to be used, as given by the following:

$$t_{net} = t - 2.5 \text{ (mm)}$$

t : As built thickness of floors and girders (mm)

- 3 The shear capacity of the double bottom is defined as a sum of the shear strengths at each end of the following members:

(1) All floors adjacent to both hoppers, less one half of the strength of the two floors adjacent to each stool, or transverse bulkheads if no stool is fitted. (See Fig. An7)

(2) All double bottom girders adjacent to stools or transverse bulkheads if no stool is fitted.

4 The strength of girders or floors of end holds which do not directly attach to boundary stools or hopper girders are to be evaluated at one end only.

5 The floors and girders to be considered are those inside the hold boundaries formed by the hoppers and stools (or transverse bulkheads if no stool is fitted). The hopper side girders and the floors directly below the connection of the bulkhead stools (or transverse bulkheads if no stool is fitted) to the inner bottom are not to be included.

6 When the shape and/or structural arrangement of the double bottom are deemed inadequate by the Society as stipulated above, the shear capacity of the double bottom is to be calculated at the discretion of the Society.

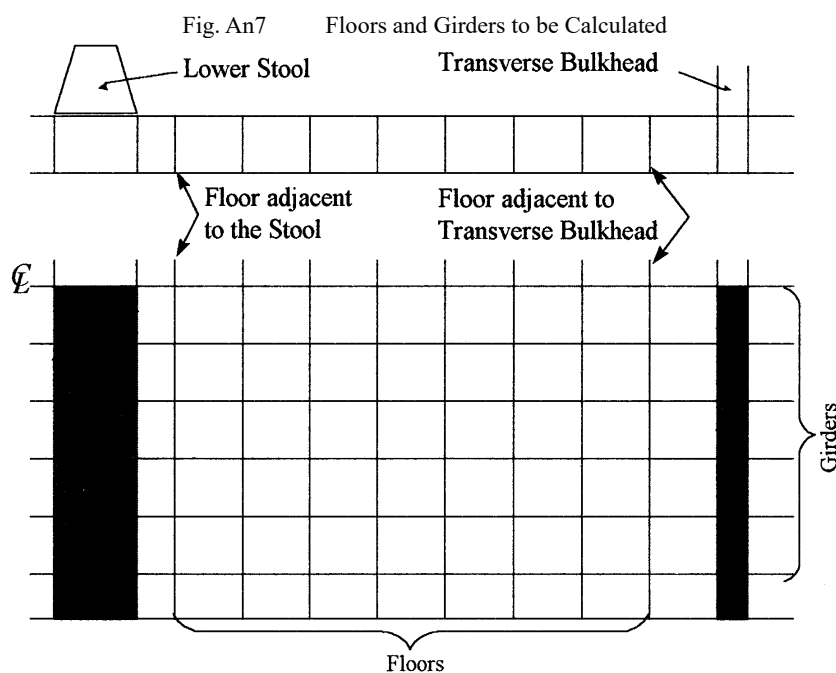

An4.3 Strength Criteria

An4.3.1

- 1 Shear capacity of double bottom C_h and C_e are to comply with the following formulae:

$$C_h = P_{FD-db} \cdot A_{DB,h} \text{ (kN)}$$

$$C_e = P_{FD-db} \cdot A_{DB,e} \text{ (kN)}$$

The variables in the above formulae are to be in accordance with the following 2 to 4.

- 2 Shear capacities of the double bottom C_h and C_e are to be obtained from the following formulae:

$$C_h = \sum \min(S_{f1}, S_{f2}) + \sum \min(S_{g1}, S_{g2}) \text{ (kN)}$$

$$C_e = \sum S_{f1} + \sum \min(S_{g1}, S_{g2}) \text{ (kN)}$$

S_{f1} , S_{f2} : The floor shear strength in way of the floor panel adjacent to hoppers, and the shear strength in way of the openings in the outmost bay (i.e. the bay closest to hoppers) are given by the following:

$$S_{f1} = 10^{-3} A_f \frac{\tau_a}{\eta_{f1}} \text{ (kN)}$$

$$S_{f2} = 10^{-3} A_{f,h} \frac{\tau_a}{\eta_{f2}} \text{ (kN)}$$

A_f : Sectional area (mm^2) of the floor panel adjacent to hoppers

$A_{f,h}$: Net sectional area (mm^2) of the openings in the outmost bay (i.e. the bay closest to hoppers)

τ_a : Allowable shear stress to be taken equal to the lesser of the following formula (however, τ_a may be taken as $\sigma_F/\sqrt{3}$ for floors adjacent to stools or transverse bulkheads):

$$\tau_a = \frac{162 \cdot \sigma_F^{0.6}}{\left(\frac{s}{t_{net}}\right)^{0.8}} \quad \text{and} \quad \frac{\sigma_F}{\sqrt{3}} \text{ (N/mm}^2\text{)}$$

σ_F : Yield stress of the material (N/mm^2)

s : Spacing (mm) of stiffening members of panel under consideration

η_{f1} : 1.10

η_{f2} : 1.20; may be reduced to 1.10, where appropriate reinforcements are fitted to the Society's satisfaction.

S_{g1} , S_{g2} : The girder shear strength in way of the girder panel adjacent to stools (or transverse bulkheads, if no stool fitted) and the girder shear strength in way of the largest openings in the outmost bay (i.e. the bay closest to stools, or transverse bulkheads, if no stool fitted) are given by the following:

$$S_{g1} = 10^{-3} A_g \frac{\tau_a}{\eta_{g1}} \text{ (kN)}$$

$$S_{g2} = 10^{-3} A_{g,h} \frac{\tau_a}{\eta_{g2}} \text{ (kN)}$$

A_g : Sectional area (mm^2) of the girder panel adjacent to stools (or transverse bulkheads, if no stool fitted)

$A_{g,h}$: Net sectional area (mm^2) of the largest openings in the outmost bay (i.e. the bay closest to stools, or transverse bulkheads, if no stool fitted)

η_{g1} : 1.10

η_{g2} : 1.15; may be reduced to 1.10 where appropriate reinforcements are fitted to the Society's satisfaction, such as in the case of **(1)** and **(2)** below.

(1) Two horizontal stiffeners are fitted on the floor and/or girder above and below the opening.

(2) A doubling plate is fitted in the circumference of the opening.

3 The load P_{FD-db} (kN/m^2) acting on the double bottom in the flooded hold condition is to be obtained from **Table An11**. In such cases, the flooding head z_F (m) under consideration is to be the vertical distance from the baseline in the absence of trim or heel, according to **Table An12**.

Table An11 Load P_{FD-db} Acting on Double Bottoms When Flooding Occurs

Flooding case	Load P_{FD-db} (kN/m^2)
$z_F > z_C$	$P_{FD-db} = \rho g[(z_C - h_{DB})(perm - 1) - E + (z_F - h_{DB})] + \rho_c g(z_C - h_{DB})$
$z_F \leq z_C$	$P_{FD-db} = \rho_c g(z_C - h_{DB}) - \rho g[E - (z_F - h_{DB})perm]$

Notes:

z_F : As specified in [Table An12](#).

z_C, h_{DB} : As specified in [Table An6](#).

ρ_c : Bulk cargo density (t/m^3). The density for steel is to be used for steel mill products⁽¹⁾.

$perm$: As specified in [An1.2.1\(7\)](#). 0 for steel mill products.

V_C : Cargo volume (m^3) for each cargo hold as given by the following formula:

$$V_C = \frac{FW}{\rho_c}$$

F : Coefficient to be taken as 1.1. However, it is to be taken as 1.05 for steel mill products.

W : Cargo mass (t) loaded in each hold

E : Ship immersion (m) for flooded hold condition as given by the following formula:

$$E = z_F - 0.1D$$

(1) The load in the cargo hold is determined by the sum of the weight of the steel products, and the weight of the flooded load, which is obtained by determining the volume of steel products in the cargo hold using the actual density of the steel mill products being loaded, and it is to be assumed that seawater enters the void spaces remaining in the cargo hold at a flooding rate of 0.95 in cases where the flooding rate for the volume of steel products being considered is assumed to be 0.

 Table An12 Flooding Head z_F (m) of Double Bottoms in the Cargo Hold Area of Bulk Carrier

Type of bulk carrier	Location of the cargo hold	
	Foremost cargo hold	Others
General ship	$z_F = D$	$z_F = 0.9D$
Bulk carriers with less than 50,000 tonnes deadweight with a type B freeboard	$z_F = 0.95D$	$z_F = 0.85D$

- 4 The areas $A_{DB,h}$ and $A_{DB,e}$ of the double bottom on which the loads are acting is to be calculated by the following:

$$A_{DB,h} = \sum_{i=1}^n S_i B_{DB,i} \quad (m^2)$$

$$A_{DB,e} = \sum_{i=1}^n S_i (B_{DB} - S_i) \quad (m^2)$$

n : Numbers of floors between stools (or transverse bulkheads, if no stool fitted)

S_i : Space (m) of i th floor

$B_{DB,i}$: $B_{DB} - S_i$ (m), for floors whose shear strength is calculated by S_{f1} .

$B_{DB,i}$: $B_{DB,h}$ (m), for floors whose shear strength is calculated by S_{f2} .

B_{DB} : Breadth (m) of double bottom between hoppers (See [Fig. An8](#))

$B_{DB,h}$: Distance (m) between the two considered openings (See [Fig. An8](#))

S_i : Spacing (m) of double bottom longitudinals adjacent to hoppers

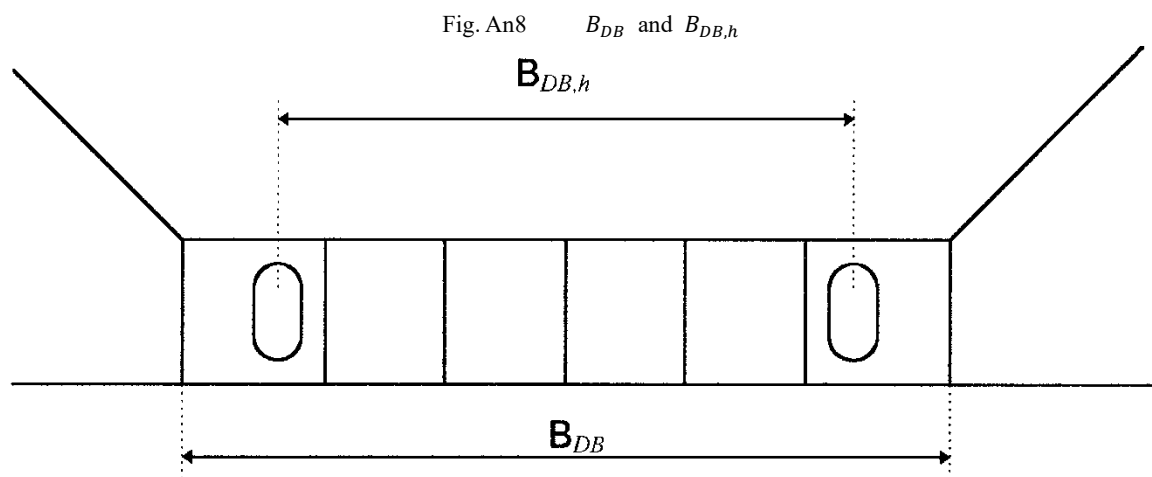

An5. Longitudinal Strength in Flooded Condition

An5.1 General

An5.1.1

1 The requirements in [An5](#) apply to bulk carriers, coming under the following (1) or (2), of not less than 150 m in length L_f designed to carry solid bulk cargoes having a density of not less than 1.0 ton/m^3 .

- (1) Bulk carriers of single-side skin construction
- (2) Bulk carriers of double-side skin construction in which any part of a longitudinal bulkhead is located within $B/5$ or 11.5 m, whichever is less, inboard from the ship's side at right angles to the centreline at the assigned summer load line

2 Ships are to have sufficient longitudinal strength to withstand flooding of any one cargo hold in the following maximum load conditions. The loads in flooded holds are to be in accordance with [An5.2](#) and the evaluation of longitudinal strength is to be in accordance with [An5.3](#).

- (1) Ballast condition (at departure and arrival)
- (2) Homogeneous loading condition (at departure and arrival)
- (3) All specific non-homogeneous loading conditions (at departure and arrival)
- (4) Other loading conditions deemed necessary by the Society

3 With respect to the requirements of -2 above, these requirements do not need to apply to harbour conditions, conditions for entering drydock, loading and unloading transitory conditions in port, and loading conditions encountered during ballast water exchange.

4 The loading condition prescribed in -2(2) to (4) above refers to cases where the ship carries bulk cargoes having a density of not less than 1.0 (ton/m^3).

5 For bulk carriers as defined in [1.3.1 \(13\), Part B](#), the ballast conditions specified in -2(1) above are to include the following conditions. Where the requirements of [An1.3.1-2](#) and [-3, Annex 3.8, Part 1](#) apply to such ships, intermediate conditions specified in [An1.3.1-2](#) and [-3, Annex 3.8, Part 1](#) are to be included with the conditions at departure and arrival. Where ballast conditions and/or cargo loaded conditions involve partially filled ballast tanks at departure, arrival or during intermediate conditions, these ballast tanks are to be added as either full or empty according to the requirements of [4.3.2.2-4](#) and [-5, Part 1](#).

- (1) In the case of empty ballast tanks in the ballast conditions prescribed in -2(1) above, the tanks are to be full (with the exception of ballast holds in a normal ballast condition).

6 Where ships are assumed to have sufficient longitudinal strength in flooded conditions, the longitudinal strength evaluation may be omitted at the Society's discretion. In this case, the reason of the omission is to be clarified.

An5.2 Loads in Flooded Holds

An5.2.1

1 The load to be considered for evaluation of longitudinal strength is the sum of cargo induced loads and flooding loads in the condition where each cargo hold is individually flooded up to the equilibrium waterline.

2 For the calculation of flooded water weight, the following are to be assumed.

- (1) The permeability of empty cargo holds and volume left in loaded cargo spaces is to be taken as 0.95.
- (2) The permeability for bulk cargoes is to be in accordance with **An1.2.1(7)**. However, for steel mill products such as steel coil, permeability is to be taken as 0 in accordance with Note (1) in **Table An11**.

3 The weight of the water in a flooded hold is to be calculated in accordance with -2, at the water level of the equilibrium water line with the assumption that each cargo hold is individually flooded. In this case, the loaded cargo may be taken to be level. The equilibrium water line is the water level that is below the lower edge of any opening through which progressive flooding may take place, after taking into account sinkage, heel, and trim.

An5.3 Strength Criteria

An5.3.1

1 The section modulus Z_f of the transverse section of the hull girder under consideration at the midship part is not to be less than the following W_z so that it has sufficient strength after flooding in all specific loading and ballast conditions:

$$W_z = 5.72 |M_{FS_max} + 0.8M_{WV-h}| \text{ (cm}^3\text{)}$$

$$W_z = 5.72 |M_{FS_min} + 0.8M_{WV-s}| \text{ (cm}^3\text{)}$$

M_{FS_max} , M_{FS_min} : The maximum and minimum vertical still water bending moment ($kN-m$) under flooded conditions as determined by the designer, to be calculated as specified in **4.3.2.2, Part 1**.

M_{WV-h} , M_{WV-s} : The vertical wave bending moment ($kN-m$) in the hogging condition and the vertical wave bending moment ($kN-m$) in the sagging condition as specified in **4.3.2.3, Part 1**.

Z_f : Actual section modulus (cm^3). Calculated in accordance with **5.2.1.4, Part 1**.

2 At sections other than the midship part, the section moduli may be required to fulfil requirements deemed necessary by the Society.

3 The thickness of side shell plating for bulk carriers of single-side skin construction under consideration is to be not less than the value obtained from the following formulae in order to have sufficient strength after flooding in all specific loading and ballast conditions:

$$t = 0.455 |Q_{FS_max} + 0.8Q_{WV-p}| \frac{m}{I} \text{ (mm)}$$

$$t = 0.455 |Q_{FS_min} + 0.8Q_{WV-n}| \frac{m}{I} \text{ (mm)}$$

Q_{FS_max} , Q_{FS_min} : The maximum and minimum vertical still water shear force (kN) under flooded conditions, to be calculated as specified in **4.3.2.2, Part 1**.

Q_{WV-p} , Q_{WV-n} : The positive vertical wave shear force (kN) and negative vertical wave shear force (kN) as specified in **4.3.2.4, Part 1**

I : Moment of inertia (cm^4) of the transverse section under consideration about its horizontal neutral axis, where the requirements in **5.2.1.4, Part 1** are to be applied to the calculation method.

m : Moment of area about the horizontal neutral axis (cm^3) on the transverse section for longitudinal members above the considered position of side shell plating when the considered position is above the horizontal neutral axis, and below the considered position when the considered position is under the horizontal neutral axis. The requirements in **5.2.1.4, Part 1** are to be applied to the calculation method.

4 The thicknesses of side shell plating and longitudinal bulkhead plating for bulk carriers of double-side skin construction under consideration is to be in accordance with **5.2.2, Part 1** in order to have sufficient strength after flooding in all specific loading and ballast conditions. In this case, the still water shear force F_s (kN), and the wave induced shear forces $F_w(+)$ and $F_w(-)$ (kN) specified in **5.2.2, Part 1** are to be in accordance with the following (1) and (2).

(1) The still water shear force F_s (kN) in the flooded condition given in -3 above is to be substituted for the still water shear force F_{sf} (kN).

(2) The wave induced shear forces $F_w(+)$ and $F_w(-)$ (kN) given in **5.2.2, Part 1** multiplied by 0.8 are to be substituted for the wave shear forces $F_w(+)$ and $F_w(-)$ (kN).

5 When calculating bending and shearing strength after flooding, the damaged structure is assumed to remain fully effective in resisting the applied load.

6 Axial stress buckling stress is to be assessed in accordance with **5.3.1, Part 1**.

7 Where the cargo in two adjacent holds divided by a transverse bulkhead becomes similar to an alternate loading condition as a

result of flooding, the shear force F_{sf} in still water after flooding may be corrected according to the requirements of 5.2.2.4, Part 1.

An6. Double-side Skin Construction and Cargo Hold Construction

An6.1 Double-side Skin Construction

An6.1.1

1 Bulk carriers of not less than 150 m in length L_f are to comply with the following requirements (1) to (6) in all areas with double-side skin construction.

- (1) Primary stiffening structures of the double-side skin are not to be placed inside the cargo hold space.
- (2) The distance between the side shell and the double side longitudinal bulkheads is not to be less than 1,000 mm measured perpendicular to the side shell as shown in Fig. An9. The double-side skin construction is to be such as to allow access for inspection as provided in 14.16, Part 1.
- (3) The minimum width of the clear passage through the double-side skin space in way of obstructions such as piping or vertical ladders is not to be less than 600 mm.
- (4) Where the inner and/or outer skins are transversely framed, the minimum clearance between the inner surfaces of the frames is not to be less than 600 mm.
- (5) Where the inner and outer skins are longitudinally framed, the minimum clearance between the inner surfaces of the frames is not to be less than mm. Outside the parallel part of the cargo hold, this clearance may be reduced where necessitated by the structural configuration, but is not to be less than 600 mm.
- (6) The minimum clearances referred to in (3) to (5) above are to be the shortest distance measured between assumed lines connecting the inner surfaces of the frames on the inner and outer skins (See Fig. An10). Such clearances need not be maintained in way of cross ties, upper and lower end brackets of transverse framing or end brackets of longitudinal framing.

2 Double-side skin spaces and dedicated seawater ballast tanks arranged in bulk carriers of not less than 150 m in length L_f are to comply with corrosion prevention systems deemed appropriate by the Society.

3 The double-side skin spaces, with the exception of top-side wing tanks are not to be used for the carriage of cargo.

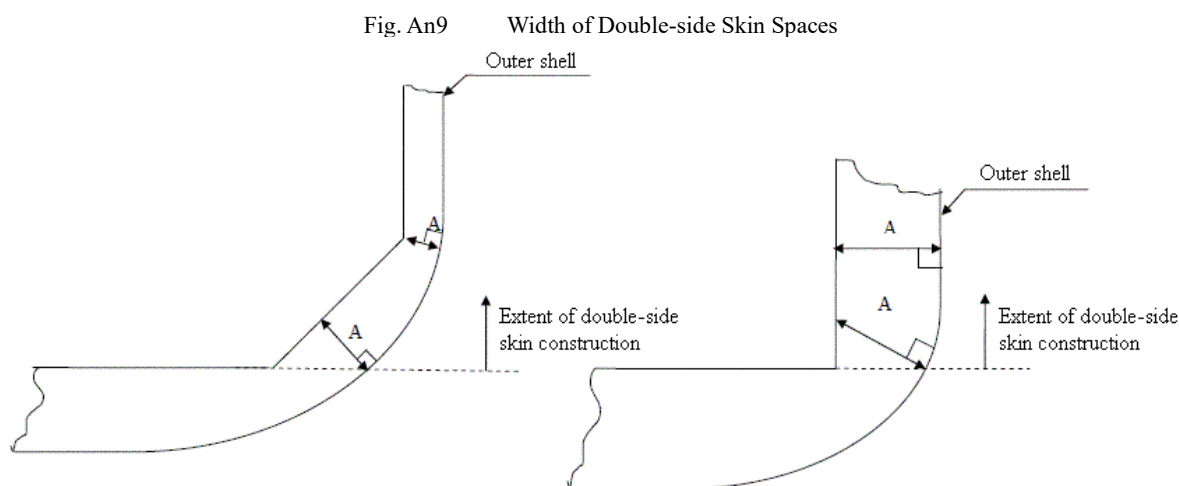

An6.2 Cargo Hold Construction

An6.2.1

1 In bulk carriers of not less than 150 m in length L_f , carrying solid bulk cargoes having a density of not less than 1.0 ton/m³, the construction of the cargo hold is to comply with the following (1) to (3).

- (1) The structure of cargo holds is to be such that all contemplated cargoes can be loaded and discharged by standard loading/discharge equipment and procedures without damage which may compromise the safety of the structure.
- (2) Effective continuity between the side shell structure and the rest of the hull structure is to be assured.
- (3) The structure of cargo areas is to be such that localized mechanical damage of one stiffening structural member will not lead to

immediate consequential failure of other structural items potentially leading to the collapse of entire stiffened panels.

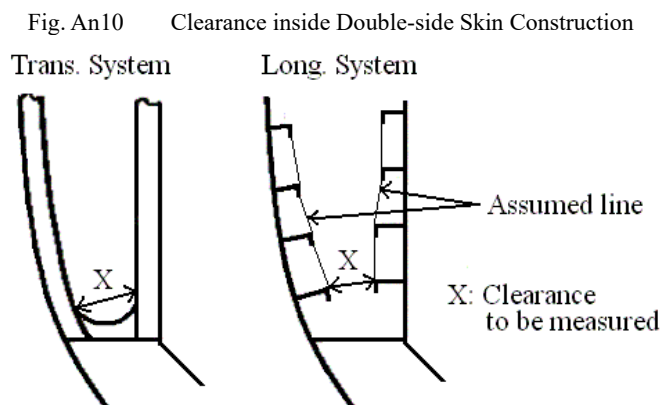

2 The structure of the cargo hold is to be in accordance with (1) and (2) below.

(1) Inner bottom and bilge hopper plating is to be increased to cater for grab operations in accordance with the provisions of 10.5. In this case, the notation “GRAB” is affixed to the Classification Characters.

(2) Appropriate means for the protection of hatchways and coamings from grab wire damage are to be taken.

3 In applying the provisions of -1(2) above, appropriate attention is to be paid for the continuity of the girders when using a double-side skin construction. For ships with single-side skin construction, the upper and lower ends of side frames are to be connected by end brackets.

4 Steel materials in the following structural members in bulk carriers of single-side skin construction are not to be less than grade *KD*, *KD32* or *KD36* as specified in Part K.

(1) Side shell strakes included totally or partially between the two points located 0.125ℓ above and below the intersection of the side shell and bilge hopper sloping plate or inner bottom plate, where ℓ is the span of the ordinary frame.

(2) Web of lower brackets of the side frame. Here, the lower brackets are specified as the area within 0.125ℓ from the lower end of the side frame.

5 The stiffeners used in cargo hold areas are to be in accordance with the buckling strength criteria as specified in the following (1) to (5), considering the pressure and axial compressive stress acting on the stiffener. The buckling strength can be examined by the provisions of 2.3.4, Section 5, Chapter 8, Part 1. Part CSR-B&T, in lieu of that specified in this section. When calculating the buckling strength, typical loading conditions are to be considered.

(1) Structural members to be considered

“Stiffeners installed in structural members that face the cargo hold” refers to the following. Stiffeners outside of $0.4L_C$ of the midship part are deemed to satisfy the requirements here if they comply with all the requirements which apply to stiffeners, unless deemed otherwise by the Society.

(a) Longitudinal stiffeners provided on inner bottom plates

(b) Longitudinal stiffeners provided on hopper plates and sloping plates of topside tanks

(c) Longitudinal stiffeners provided on longitudinal bulkheads (excluding corrugated bulkheads)

(d) Horizontal stiffeners provided on hatch side coamings over $0.15L$ in length

(e) Vertical stiffeners provided on transverse bulkheads (excluding corrugated bulkheads)

(f) Vertical stiffeners provided on sloping plates and vertical plates of lower stool and upper stool of transverse bulkheads

(g) Side frames (single-side skin construction only)

(h) Stiffeners other than (a) to (g) above that have high pressure and high axial compressive stress acting on them simultaneously

(2) Pressure acting on stiffeners

The pressure p (kN/m^2) acting on stiffeners is given by the following (a) to (c) depending on the stiffener considered. When pressure is applied from the stiffener side, p is to be taken as a negative value and when pressure is applied from the side opposite to the stiffener, p is to be taken as a positive value.

(a) Pressure p (kN/m^2) due to dry bulk cargo is given by the following formula:

$$p = \gamma(1 + C_1)gK_C h_1$$

γ : Specific gravity of cargo given by the following formula:

$$\gamma = \frac{M}{V} \text{ (t/m}^3\text{)}$$

M : Maximum cargo mass (t) given for each cargo hold

V : Volume (m^3) of the hold excluding its hatchway

C_1 : Coefficient obtained from [Table An13](#) depending on L_C . For intermediate values of L_C , C_1 is to be obtained by linear interpolation.

K_C : Coefficient given by the following:

For stiffeners provided on hatch side coamings, sloping plates of topside tanks, sloping plates of upper stools (excluding vertical plates, See [Fig. An11](#)) and side frames: $K_C = 0$

For stiffeners other than above: $K_C = \cos^2 \alpha + (1 - \sin \psi) \sin^2 \alpha$

α : Angle of inclination (*degrees*) of the panel considered on the side not facing the cargo hold with respect to the horizontal plane

ψ : Angle of repose (*degrees*) of cargo. The value given in [Table An14](#) may be used as the standard value corresponding to the type of cargo.

h_1 : Vertical distance (m) from the mid-point of the stiffener under consideration to the upper deck at centre line

(b) Pressure p (kN/m^2) due to ballast water is given by the following formulae.

For ballast tanks excluding ballast hold: $p = 1.025(1 + C_2)gh_2$

For ballast hold: $p = 1.025(1 + C_2)gh_3$

C_2 : Coefficient obtained from [Table An15](#) depending on L_C (m). For intermediate values of L_C , C_2 is to be obtained by linear interpolation.

h_2 : Vertical distance (m) from the mid-point of the stiffener under consideration to the middle point of the distance from the tank top to the upper end of overflow pipe

h_3 : Vertical distance (m) from the mid-point of the stiffener under consideration to the top of the hatch coaming

(c) Total external sea pressure p (kN/m^2) is given by the following formula.

$$p = 1.025gh_4$$

h_4 : Vertical distance (m) from the mid-point of the side frame or horizontal stiffener of hatch side coaming under consideration to the point $d + 0.05L_{C230}$ above the top of keel Where the position of the hatch side coaming is higher than $d + 0.05L_{C230}$ above the top of keel, h_4 is to be taken equal to zero.

(3) Reference Stress

Reference stress σ_{ref} (N/mm^2) of the stiffener is given by the following (a) to (e) depending on the type of stiffeners under consideration.

(a) In case of longitudinal stiffeners, reference stress is to be obtained from the following i) or ii), whichever is greater.

i) Compressive stress due to longitudinal hull girder bending moment, obtained from the following formula, but not less than $30/K$. For members located above the horizontal neutral axis, sagging condition is to be considered and for members located below the horizontal neutral axis, hogging condition is to be considered.

$$\sigma_V = \frac{M_S + M_W}{I} z \times 10^5 \text{ (N/mm}^2\text{)}$$

M_S : Allowable still water bending moment ($kN-m$) However, in ballast condition, M_S may be taken as the greater of the values specified in the following 1) or 2). M_S is to be calculated for hogging and sagging conditions respectively.

1) 120% of the actual hull girder bending moment in the ballast condition specified in the loading manual but not in excess of the allowable still water bending moment

Where the ballast condition includes intermediate conditions specified in [An1.3.1-2](#) and -3 in [Annex 3.8, Part 1](#), the partially filled ballast tanks do not need to be considered as being full or empty

2) Half of the allowable still water bending moment

M_W : Wave longitudinal bending moments ($kN-m$) as specified in [4.3.2.3, Part 1](#).

z : Vertical distance (m) from the horizontal neutral axis to the location of the member considered in the

athwartship section under consideration

I : Gross moment of inertia (cm^4) at the athwartship section considered

ii) Compressive stress due to horizontal hull girder bending moment, given by the following formula:

$$\sigma_H = C_3 \frac{2y}{B} \text{ (N/mm}^2\text{)}$$

C_3 : Coefficient given by the following formulae For the intermediate values of L_C (m), C_3 is to be obtained by linear interpolation.

$$\text{For } L_C \leq 230 \text{ m : } C_3 = \frac{6}{a} g$$

$$\text{For } L_C \geq 400 \text{ m : } C_3 = \frac{10.5}{a} g$$

a : \sqrt{K} when high tensile steels are used for not less than 80% of side shell plating at the athwartship section amidships, and 1.0 for other parts.

K : Coefficient corresponding to the kinds of steels of side shell plating as specified in **3.2.1.2, Part 1**.

y : Athwartship distance (m) from centreline of the hull to the point under consideration

(b) Reference stress for horizontal stiffeners of hatch side coamings is given by the following **i**) or **ii**).

i) When the stiffener is fitted on a continuous hatch side coaming, **(a)** above is to be applied treating the stiffener as a longitudinal stiffener.

ii) When the stiffener is fitted on a discontinuous hatch side coaming, **(a)** above is to be applied treating the stress as bending stress at deck.

(c) The reference stress of vertical stiffeners of slant and vertical plating of upper and lower stools of transverse bulkheads and transverse bulkheads (excluding corrugated bulkheads) is given by the following **i**) or **ii**), depending on the loading condition and loading pattern. When the axial compressive stress at the mid-point of the stiffener is calculated by direct strength analysis, the value may be used as the reference stress, but it is not to be less than $30/K$ (See **Fig. An12**).

i) When relatively high axial compressive stress is acting on the stiffener (e.g. vertical stiffeners of the stool facing an empty hold in alternately cargo-loaded condition or those facing a hold adjacent to a heavy ballast hold in heavy ballast condition), reference stress is given by the following formula:

$$\sigma_{ref} = 145/K \text{ (N/mm}^2\text{)}$$

ii) In other cases, given by the following formula:

$$\sigma_{ref} = 30/K \text{ (N/mm}^2\text{)}$$

K : Coefficient corresponding to the kinds of steels of stiffeners, as specified in **3.2.1.2, Part 1**.

(d) In case of side frames, reference stress is obtained from the following formula:

$$\sigma_{ref} = 30/K \text{ (N/mm}^2\text{)}$$

K : As specified in **(c)** above.

(e) The reference stress of members other than those specified in **(a)** to **(d)** above is to be determined as deemed appropriate by the Society.

(4) Buckling Stress

Buckling stress σ_{Uxp} (N/mm^2) of the stiffener considered is given by the following **(a)** or **(b)** corresponding to the pressure acting on the stiffener. In calculating the buckling stress, the value is to be reduced by the thickness of each part of the member concerned, as shown in **Table An16**, when using t_b , t_w and t_f in formulas for determining **(a)** and **(b)**.

(a) For $0 \leq p \leq p_{cr}$ or $-p_{cr} \leq p \leq 0$:

$$\sigma_{Uxp} = \min(\sigma_{Pl}, \sigma_{Sl})$$

$$\sigma_{Pl} = \frac{A_e}{2A} \left\{ P_C \left[\frac{1}{A_e} + \frac{y_p}{I_e} \left(w_s + \frac{5l^4 s |p|}{384 \times 10^3 E I_e} \right) \right] + \sigma_Y - \frac{pl^2 s}{8 \times 10^3 I_e} \frac{y_p}{I_e} \right. \\ \left. - \sqrt{\left\{ P_C \left[\frac{1}{A_e} + \frac{y_p}{I_e} \left(w_s + \frac{5l^4 s |p|}{384 \times 10^3 E I_e} \right) \right] + \sigma_Y - \frac{pl^2 s}{8 \times 10^3 I_e} \frac{y_p}{I_e} \right\}^2 - 4 \left(\sigma_Y - \frac{pl^2 s}{8 \times 10^3 I_e} \frac{y_p}{I_e} \right) \frac{P_C}{A_e}} \right\}$$

$$\sigma_{SI} = \frac{A_e}{2A} \left\{ P_C \left[\frac{1}{A_e} + \frac{y_s}{I_e} \left(w_s + \frac{l^4 s |p|}{384 \times 10^3 E I_e} \right) \right] + \sigma_Y + \frac{p l^2 s}{24 \times 10^3 I_e} \frac{y_s}{I_e} \right. \\ \left. - \sqrt{\left\{ P_C \left[\frac{1}{A_e} + \frac{y_s}{I_e} \left(w_s + \frac{l^4 s |p|}{384 \times 10^3 E I_e} \right) \right] + \sigma_Y + \frac{p l^2 s}{24 \times 10^3 I_e} \frac{y_s}{I_e} \right\}^2 - 4 \left(\sigma_Y + \frac{p l^2 s}{24 \times 10^3 I_e} \frac{y_s}{I_e} \right) \frac{P_C}{A_e}} \right\}$$

(b) For $p \geq p_{cr}$ or $p \leq -p_{cr}$:

$$\sigma_{Uxp} = \sigma_{HI}$$

$$\sigma_{HI} = -\frac{\sigma^*_{HI}}{p_{st} - p_{cr}} (|p| - p_{cr}) + \sigma^*_{HI}$$

$$\sigma^*_{HI} = \min(\sigma_{pI(p=p_{cr})}, \sigma_{SI(p=p_{cr})})$$

The following definitions apply to (a) and (b) above.

p : Pressure (kN/m^2) acting on the stiffener considered, as specified in (2) above

p_{cr} : Plastic collapse load of attached plating considered, which is obtained from the following formula:

$$p_{cr} = \frac{12}{l^2 s} \frac{I}{y_{s0}} \sigma_Y \times 10^3 \text{ (kN/m}^2\text{)}$$

p_{st} : Plastic collapse load of stiffener considered, which is obtained from the following formula:

$$p_{st} = \frac{16}{l^2 s} Z_p \sigma_Y \times 10^3 \text{ (kN/m}^2\text{)}$$

P_C : Euler's buckling load, as obtained from following formula:

$$P_C = \frac{\pi^2 E I_e}{l^2} \text{ (N)}$$

I : Moment of inertia (mm^4) of stiffener including attached plating with full width

I_e : Moment of inertia (mm^4) of stiffener including attached plating with effective width

Z_p : Plastic section modulus (mm^3) of stiffener including attached plating

y_p : Vertical distance (mm) from neutral axis of stiffener including attached plating to the mid point of thickness of attached plating

y_s : Vertical distance (mm) from neutral axis of stiffener including attached plating with effective width to the outer surface of the face plate

y_{s0} : Vertical distance (mm) from neutral axis of stiffener including attached plating with full width to the outer surface of the face plate

σ_Y : Yield stress (N/mm^2) of stiffener including attached plating, obtained from following formula:

$$\sigma_Y = \left\{ s t_p \sigma_{Yp} + \left((h_w - t_f) t_w + b_f t_f \right) \sigma_{YS} \right\} / A$$

σ_{Yp} : Yield stress (N/mm^2) of material of attached plating under consideration

σ_{YS} : Yield stress (N/mm^2) of material of stiffener under consideration

l : Span of stiffener (mm) However, where suitable end brackets are fitted, the span of the stiffener which is used in the formulae except α_p , m_1 and P_C may be corrected as specified in the following i) or ii) depending on the type of end bracket (See Fig. An13).

i) The span is taken between points where the depth of the bracket is equal to half the depth of the stiffener web

ii) Where the face plate of the stiffener is continuous along the face of the bracket, the span is taken between points where the depth of the bracket is equal to one quarter the depth of the web

A : Cross sectional area (mm^2) of stiffeners including attached plating with full width, which is given by the following formula:

$$A = s t_p + (h_w - t_f) t_w + b_f t_f$$

A_e : Cross sectional area (mm^2) of stiffeners including attached plating with effective width, which is given by the following formulae:

$$A_e = s_e t_p + (h_w - t_f) t_w + b_f t_f \text{ for angles and T-sections}$$

$$A_e = s_e t_p + (h_w - t_f) t_e \text{ for flat bars}$$

s : Spacing of stiffeners (mm)

t_p : Plate thickness (mm) of attached plating

h_w : Web height (mm)

t_w : Web thickness (mm)

b_f : Width of face plate (mm)

t_f : Thickness (mm) of face plate. For bulb sections, the mean thickness of the bulb is to be used.

t_e : Effective thickness (mm) of attached plating, obtained from the following formula.

$$t_e = t_w \left[1 - \frac{2\pi^2}{3} \left(\frac{h_w}{s} \right)^2 \left(1 - \frac{s_e}{s} \right) \right]$$

s_e : Effective width (mm) of attached plating, obtained from the following formula.

$$s_e = \left(\frac{\sigma_{crx}}{\sigma_{Yp}} (1 - \alpha_p) + \alpha_p \right) s$$

$$\frac{\sigma_{crx}}{\sigma_{Yp}} = \frac{1}{2} \left(\frac{\sigma_{crex}}{\sigma_{Yp}} + 1 - \sqrt{\left(\frac{\sigma_{crex}}{\sigma_{Yp}} - 1 \right)^2 + 0.01} \right)$$

$$\sigma_{crex} = \kappa_x \sigma_{crex(p)}$$

$$\sigma_{crex(p)} = \frac{E\pi^2}{3(1-\nu^2)} \left(\frac{t_p}{s} \right)^2$$

$$\kappa_x = c_x \left(\frac{t_w}{t_p} \right)^3 + 1$$

c_x : Coefficient according to the type of stiffeners, which is given by the following:

$$c_x = 0.07 \text{ for angles and } T\text{-sections}$$

$$c_x = 0.02 \text{ for flat bars}$$

$$\alpha_p = \frac{1 + (l/m_1 s)^4}{3 + (l/m_1 s)^4}$$

m_1 : Integer which satisfies the following formula:

$$\sqrt{(m_1 - 1)m_1} \leq l/s \leq \sqrt{m_1(m_1 + 1)}$$

w_s : Assumed imperfection of stiffeners (mm) The value of $l/1000$ may be used as standard.

E : Modulus of elasticity for material: 2.06×10^5 for steel (N/mm^2)

(5) Buckling Strength Criteria

The buckling strength of stiffeners specified in (1) above is to comply with the following formula:

$$\frac{\sigma_{Uxp}}{\sigma_{ref}} \geq 1.15$$

σ_{ref} : Reference stress (N/mm^2) of the stiffener considered, as specified in (3) above

σ_{Uxp} : Buckling stress (N/mm^2) of the stiffener considered, as specified in (4) above

Table An13 Coefficient C_1

L_C (m)	150	200	250	300 or more
C_1	0.525	0.4	0.35	0.3

Table An14 Angle of Repose

Cargo and etc.	Angle of repose ψ
General	30°
Iron ore, coal	35°
Cement	25°

Fig. An11

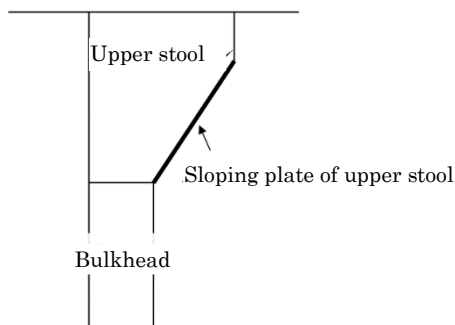
 Table An15 Coefficient C_2

L_C (m)	150	200	250	300 or more
C_2	0.4	0.3	0.25	0.2

Fig. An12 Example of Reference Stress

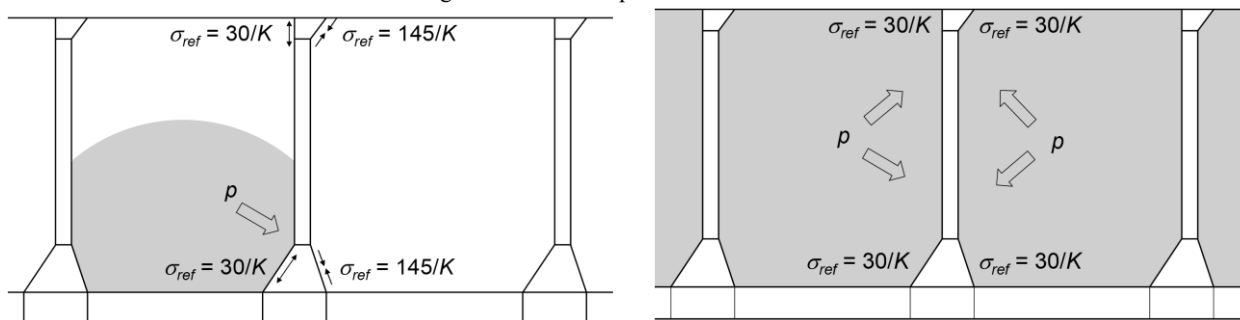

Table An16 Standard Deduction

Structure	Standard deduction (mm)	Limit value (mm)	
		Minimum	Maximum
1. Compartments carrying dry bulk cargoes and void spaces 2. One side exposure to ballast and/or liquid cargo Vertical surfaces and surfaces sloped at an angle greater than 25° to the horizontal line 3. Hatch side coaming	0.05t	0.5	1.0
1. One side exposure to ballast and/or liquid cargo Horizontal surfaces and surfaces sloped at an angle less than 25° to the horizontal line 2. Two side exposure to ballast and/or liquid cargo Vertical surfaces and surfaces sloped at an angle greater than 25° to the horizontal line	0.10t	2.0	3.0
1. Two side exposure to ballast and/or liquid cargo Horizontal surfaces and surfaces sloped at an angle less than 25° to the horizontal line	0.15t	2.0	4.0

Note:

 t : Thickness (mm) of structural members under consideration

Fig. An13 Span of Stiffeners

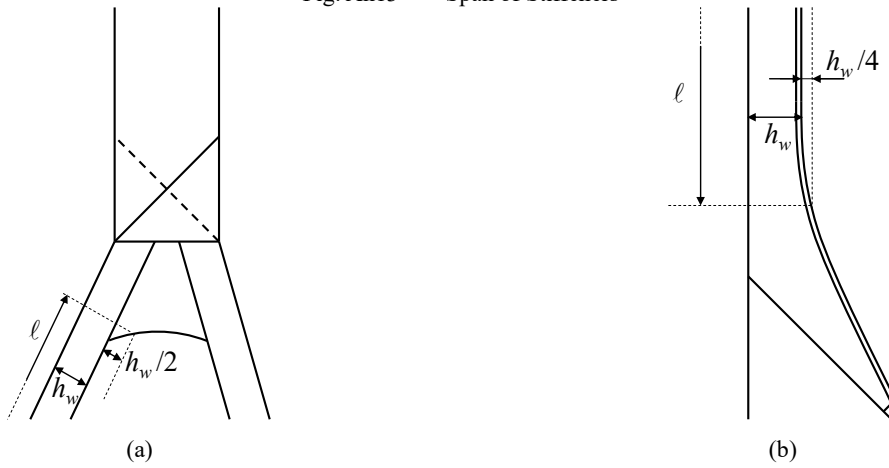
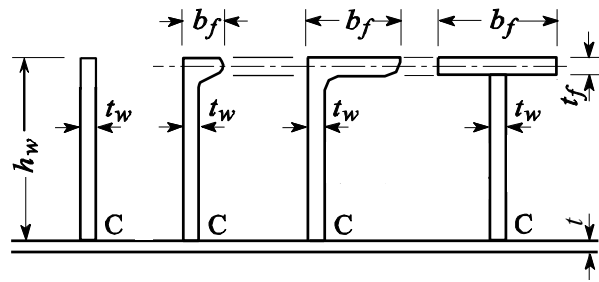

Fig. A14 Dimensions of Stiffeners



Part 2-3 ORE CARRIERS

Chapter 1 GENERAL

1.1 General

1.1.1 Application

1.1.1.1 Application of this Part

1 The hull construction and equipment of ships intended to be registered as ore carriers, affixed with the notation “*Ore Carrier*” (abbreviated as *OC*), are to be in accordance with the requirements in **Part 2-3** in addition to **Part 1**.

2 The requirements in **Part 2-3** are for ships intended for the carriage of ore cargoes or similar cargoes having equivalent high densities, generally having a single deck as well as two longitudinal watertight bulkheads and double bottoms throughout the cargo spaces, and decks and bottoms framed longitudinally. (See **Fig. 1.1.1-1**)

3 Ore carriers with a different construction from that specified in -2 above, to which the requirements in this Part are considered to be not applicable, are to be at the discretion of the Society.

Fig. 1.1.1-1 Typical Structural Arrangement of Ore Carriers

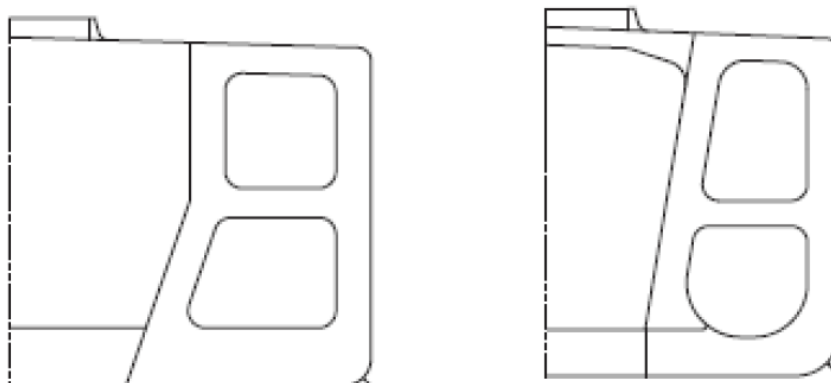

1.1.1.2 Application of Chapter XII of the SOLAS Convention

Ore carriers to which **Part 2-3** applies are to comply with the **Annex 1.1 in Chapter 1 of Part 2-2 “Additional Requirements for Bulk Carriers in Chapter XII of the SOLAS Convention”**.

1.2 Definitions

1.2.1 Naming Convention

1.2.1.1 Structural Nomenclature

Fig. 1.2.1-1 show the common structural nomenclature used in **Part 2-3**.

Fig. 1.2.1-1 Ore Carriers

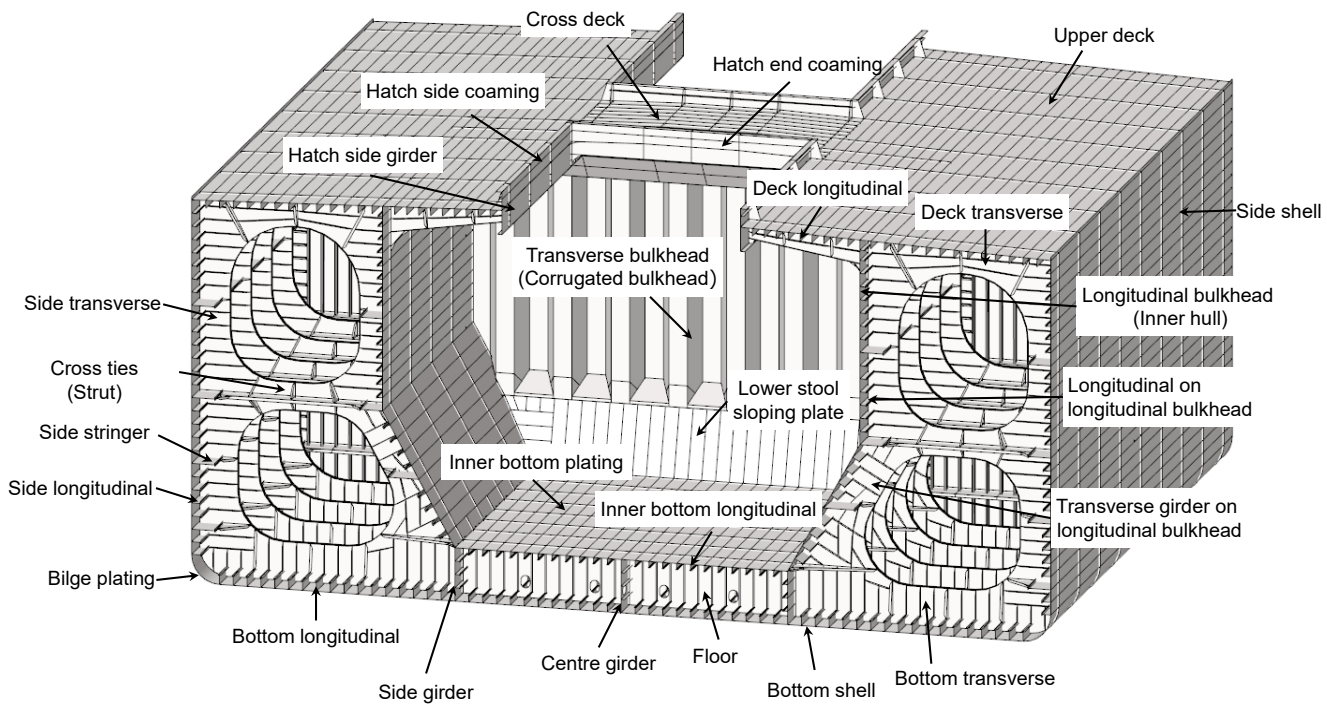

Chapter 2 GENERAL ARRANGEMENT DESIGN

2.1 Structural Arrangements

2.1.1 Double Bottoms

2.1.1.1 General

1 The height of double bottoms is to be determined so that the centre of gravity of the ship is not excessively low in full load condition. However, the height is not to be less than h (m) as specified in [2.4.1.1-1 in Part 1](#).

2 Floors or bottom transverses are to be arranged at the positions of bulkheads or transverses in wing tanks or void spaces.

Chapter 3 STRUCTURAL DESIGN PRINCIPLES

3.1 (Deleted)

3.2 Loading Manual and Loading Instruments

3.2.1 Loading Manual

3.2.1.1 Additional Requirements for the Loading Manual

1 In applying the requirements of **3.8.2.1-3, Part 1**, the loading manual is to include the following items. Further, for ships where L_f is less than 150 m, descriptions regarding (3) may be limited to the maximum allowable cargo mass for each cargo hold. In addition, the issue regarding (4) may not be described.

- (1) For ships for which **Annex 1.1, Chapter 1, Part 2-2 “Additional Requirements for Bulk Carriers in Chapter XII of the SOLAS Convention”** applies, envelope results and permissible limits of still bending moments and shear forces in the hold flooded condition according to the requirements given in the Annex. However, results deemed by the Society as too small to affect the strength of the ship may be omitted.
- (2) The cargo holds or combination of cargo holds that might be empty at full draught. Where no cargo hold is allowed to be empty at full draught, this is to be clearly stated in the loading manual.
- (3) Maximum allowable and minimum required mass of cargo and double bottom contents of each hold as a function of the draught at mid-hold position.
- (4) Maximum and minimum required mass of cargo and double bottom contents of any two adjacent holds as a function of the mean draught. This means draught may be calculated by averaging the draught of the two mid-hold positions.
- (5) Maximum allowable tank top loading together with specification of the nature of the cargo for cargoes other than bulk cargoes. Where the ship is not approved to carry cargoes other than bulk cargoes, this is to be clearly stated in the loading manual.
- (6) Maximum allowable load on deck and hatch covers. Where the ship is not approved to carry loads on deck and hatch covers, this is to be clearly stated in the loading manual.
- (7) Maximum rate of ballast change together with the advice that a load plan is to be agreed with the terminal on the basis of the achievable rates of change of ballast.
- (8) For ships to which **Annex 1.1, Chapter 1, Part 2-2** applies, include the bulk cargo density for strength requirements in accordance with the annex. It is to be clearly stated in the loading manual as follows, “Where cargoes of a bulk cargo density greater than that specified are to be loaded, the interaction of the load with the strength of the hull is to be reviewed before loading.”
- (9) When setting the maximum and minimum filling levels of the side ballast tanks other than full or empty tanks, said maximum and minimum filling levels are to be indicated in the loading manual.

2 In applying the requirements of **3.8.2.1-3, Part 1**, the loading conditions specified in the following (1) to (8), subdivided into departure and arrival conditions, are to be included in the loading manual for both departure and arrival. Where the design of the ship is based on conditions (3), (4), (5), (7) and (8), these are to be included in the loading manual. Further, for ships L_f is less than 150 m, item (8) may not be included, and items (6) and (7) may be also modified so that loading manuals are to include general restrictions and/or instructions for loading, unloading, ballasting and de-ballasting with regard to the strength of the ship’s structures.

- (1) Homogeneous light and heavy cargo loading conditions at maximum draught
- (2) Ballast conditions. Ships having ballast holds adjacent to topside wing, hopper, and double bottom tanks are to have sufficient structural strength to allow the ballast holds to be filled when these topside wing, hopper, and double bottom tanks are empty.
- (3) Alternate light and heavy cargo loading conditions at maximum draught
- (4) Multiple port loading/unloading conditions
- (5) Deck cargo conditions
- (6) Typical loading/unloading sequences. This is to detail the loading sequence from the commencement of cargo loading to when

the ship reaches full deadweight capacity and the unloading sequence from full deadweight capacity to empty conditions. These sequences are to be developed paying attention to the loading rate, ship strength, and de-ballasting capability using [Table 3.2.1-1](#).

- (7) Typical sequences for a change of ballast at sea
- (8) Short voyage conditions where the ship is to be loaded to maximum draught but with a limited amount of bunkers

3 For ships using multiple cargo holds as ballast holds, the loading manual is to include a provision stating that multiple ballast holds cannot be filled with ballast water at the same time unless the ship is designed to allow the filling of multiple ballast holds at the same time.

4 When loading cargo that is not included in the loading manual which may impact the local strength of double bottom construction, such as steel coil, heavy goods and others the loading manual is to note that the maximum allowable cargo mass and the minimum required mass of cargo are to be considered separately.

5 In applying **-2(6)** above, the loading manual is to at least include the loading/unloading sequences for cargo in the following loading conditions. However, with the exclusion of the following **(1)**, only loading conditions that the ship is designed to accommodate is to be included in the loading manual.

- (1) Homogenous loading condition specified in **-2(1)** above
- (2) Alternate loading condition specified in **-2(3)** above
- (3) Multiple port loading/unloading condition specified in **-2(4)** above
- (4) Deck cargo condition specified in **-2(5)** above
- (5) Short voyage condition specified in **-2(8)** above
- (6) Block loading (partial loading condition; loaded cargo in over two adjacent holds)

6 The steps of a sequence required in **-5** above are to be specified as follows. A step is defined as each time the loading equipment changes its position to a new hold. The vertical bending moment and vertical shear force are to be confirmed to be within their allowable limits using a loading computer for each step of each loading condition.

- (1) For loading cargo: Each step between commencement of cargo loading in the ballasted condition and the planned loading condition
- (2) For unloading cargo: Each step between commencement of unloading cargo in the planned loading condition and the ballast condition at departure

7 For each step of each loading condition specified in **-5** above is to be within their allowable limits of vertical bending moments and vertical shear forces.

8 The loading manual is to contain the loading/unloading sequence summary forms as specified in [Table 3.2.1-1](#) with the following note:

“When loading/unloading not in the planned way or as specified in the loading manual, new loading/unloading sequences are to be developed with the specified forms, paying attention to loading rate, ballasting/deballasting capability, longitudinal strength, and maximum allowable and minimum required mass of cargo and double bottom contents.”

Table 3.2.1-1 Standard Loading/Unloading Sequences (Form 1)

LOADING/UNLOADING SEQUENCE SUMMARY FORM

Vessel name	Voyage No.	Condition	Yard ID Number C/xxxx/M/xxxx
-------------	------------	-----------	---------------------------------

Hold No.	7	4	3	2	1
Volume of Hold V(m ³)					
Height of Hold H(m)					

Part (specific or typical):

Total mass of cargo to be loaded/discharged:

Deck water density (t/m³):

Number of Loads/discharges:

Conditions at commencement of loading/discharges:

Conditions at end of loading/discharges:

Maximum Loading/discharging rate:

Maximum Ballasting/Deballasting rate:

Average Loading/discharging rate:

Average Ballasting/Deballasting rate:

[Note: During each port it has to be controlled that allowable limits for hull girder shear force, bending moments and mass in holds are not exceeded. Loading/discharging operations may have to be paused to allow for ballasting/deballasting in order to keep actual values within limits.]

Cargo mass/Grade	Hold content at commencement of loading/discharging						Ballasting content at commencement of loading/discharging						
	Wage of peak/Upper/Lower/Peaks	AFT	No. E.T.	No. E.T.	No. E.T.	No. E.T.	No. E.T.	No. E.T.	No. E.T.	No. E.T.	No. E.T.	FPT	
Four No./Grade	Hold 7	Hold 4	Hold 3	Hold 2	Hold 1	Upper/Lower/Peaks	No. E.T.	No. E.T.	No. E.T.	No. E.T.	No. E.T.	No. E.T.	FPT
1						Upper/Lower/Peaks							
2						Upper/Lower/Peaks							
3						Upper/Lower/Peaks							
4						Upper/Lower/Peaks							
5						Upper/Lower/Peaks							
6						Upper/Lower/Peaks							
7						Upper/Lower/Peaks							
8						Upper/Lower/Peaks							

Draft Survey n-1	Total cargo onboard (t):	Remaining cargo to be loaded (t):	Total amount of Pounds onboard (t):
Draft Survey n			

Cargo mass:	Hold content at end of loading/discharging	Ballasting contents at end of loading/discharging	Values at end of loading/discharging (sea)
	Wage of peak/Upper/Lower/Peaks	Ball no.5 Ball no.6 Ball no.3 Ball no.4 Ball no.2 Ball no.1 FPT	Taft Trim Twd Maximum
	Total mass Loaded/Discharging (t)		(m) (m) (m) % F (%) % E % M (%)

Maximum occurring values among all conditions above

Net load on Double Bottom	tonne/m		
Net load in two Adjacent holds	tonne		

Approved by: _____

Date: _____

3.2.1.2 Relationship Between the Maximum Allowable Cargo Mass, Minimum Allowable Cargo Mass, and the Draught in Single Cargo Holds

1 When including the relationship between the draught and the maximum allowable cargo mass in the loading manual in applying 3.2.1.1-1(3), the maximum allowable cargo mass for each standalone cargo hold W_{MAX} is to be given by the following (1) and (2) as a function of the draught of the cargo hold.

- (1) When the member scantling of the double bottoms structure is determined based on requirements of Chapter 6, Part 1 and Chapter 7, Part 1, the maximum allowable cargo mass $W_{MAX}(t)$ is to satisfy the requirements of the Table 3.2.1-2.

- (2) When performing a strength assessment of the double bottoms structure based on requirements of **Chapter 8** and **Chapter 8, Part 1**, the maximum allowable cargo mass W_{MAX} (t) is to satisfy the requirements of the **Table 3.2.1-3**.

Table 3.2.1-2 Maximum Allowable Cargo Mass (When the Member Scantling is Determined by the Formula in the Rules)

	Formula used to calculate the maximum allowable cargo mass
Maximum allowable cargo mass (t)	$W_{MAX} \leq \gamma f(h_x)$
The pressure which works on the ship's bottom due to the mass of cargo or ballast water P_{btm} (kN/m ²)	$P_{btm} \leq \max(a_1 n_{f1}, a_2 n_{f2}, \dots, a_n n_{fn}) + \rho g T_x - \alpha_{R1} P_{exw1} - \rho g h_{BST}$
Notes: P_{btm} : As given by the following formula: $P_{btm} = \gamma g h_x$ γ : The design cargo density in the cargo hold, the maximum cargo mass of the cargo hold divided by the volume of the cargo hold (excluding the hatchway) (t/m ³) $f(h_x)$: The function which shows the relationship between the stowage height h_x (m) of cargo at the centre line and the volume (m ³) of cargo loaded in the hold. In this case, the cargo may be assumed to be loaded uniformly with a level surface. h_x : Stowage height (m) to the cargo surface from the tank top at the centre line a_i : Difference in pressure (kN/m ²) in loading condition No. i taken from the total of n loading conditions, which works on the centre line of the ship's bottom due to the mass of cargo, ballast water and/or double bottom contents and by wave and still water corresponding to the draught, which is obtained from the following formula The difference in pressure cannot, however, exceed the design pressure given to the local structural member of the double bottom where the member is reinforced to enable the ship to carry heavy cargoes such as steel coils. $a_i = \max(p_i - (\rho g T_i + P_{exw1}) , p_i - (\rho g T_i - P_{exw1}))$ p_i : Pressure (kN/m ²) in loading condition No. i , which works on the centre line of the ship's bottom by the mass of cargo, ballast water and/or double bottom contents T_i : Draught (m) in loading condition No. i , at mid-hold position of cargo hold length α_{R1} : Coefficient to be taken as 1.0. However, on waters where there are small effects of ocean waves such as in a port area, that may be reduced to 0.5. P_{exw1} : Hydrodynamic pressure (kN/m ²), to be taken as the value of P_{HM} specified in 4.6.2.4-2(1), Part 1 . In this case, T_{LC} is taken as T_i and load calculation points are points for bottom shell as specified in 7.3.1.5, Part 1 n_{fi} : 0.9 in loading condition No. i , where the considered hold and either of the adjacent holds are loaded or empty simultaneously. In the other case, it is to be 1.0. T_x : Draught (m) at mid-hold position of cargo hold length h_{BST} : Water heads (m) of ballast water charged in the double bottom at the centre line. In any case, it cannot exceed height of the double bottom.	

Table 3.2.1-3 Maximum Allowable Cargo Mass (When Performing Strength Assessment by Cargo Hold Analysis)

	Formula used to calculate the maximum allowable cargo mass
Maximum allowable cargo mass (t)	$W_{MAX} \leq \gamma f(h_x)$
The pressure which works on the ship's bottom due to the mass of cargo or ballast water P_{btm} (kN/m^2)	$P_{btm} \leq \max(a_1, a_2, \dots, a_n) + \rho g T_x - \alpha_{R2} P_{exw1} - \rho g h_{BST}$
Notes: P_{btm} , γ , $f(h_x)$, h_x , T_i , T_x , h_{BST} , P_{exw1} : As specified in Table 3.2.1-2 . a_i : Difference in pressure (kN/m^2) in loading condition No. i taken from the total of n loading conditions, which works on the centre line of the ship's bottom due to the mass of cargo, ballast water and/or double bottom contents and by wave and still water corresponding to the draught, which is obtained from the following formula. The difference in pressure cannot, however, exceed the design pressure given to the local structural member of the double bottom where the member is reinforced to enable the ship to carry heavy cargoes such as steel coils. $a_i = \max(p_i - (\rho g T_i + P_{exw1}) , p_i - \rho g T_i - P_{exw1})$ p_i : Pressure (kN/m^2) in loading condition No. i , which works on the centre line of the ship's bottom by the mass of cargo, ballast water and/or double bottom contents. In calculating the pressure which arises from the mass of cargo, the density of the cargo and the shape of the cargo surface which were applied in strength assessment by cargo hold analysis may be taken into consideration. α_{R2} : Coefficient to be taken as 1.0. On waters where there are small effects of ocean waves such as in a port area, it may be reduced to one-third.	

2 When including the relationship between the draught and the maximum allowable cargo mass in the loading manual in applying [3.2.1.1-1 \(3\)](#), the minimum allowable cargo mass W_{MIN} for each standalone cargo hold is to be given by the following (1) and (2) as a function of the draught of the cargo hold.

- (1) When the member scantling of the double bottoms structure is determined based on requirements of [Chapter 6, Part 1](#) and [Chapter 7, Part 1](#), the minimum allowable cargo mass W_{MIN} (t) is to satisfy the requirements of the [Table 3.2.1-4](#).
- (2) When performing strength assessment of the double bottoms structure based on requirements of [Chapter 8](#) and [Chapter 8, Part 1](#), the minimum allowable cargo mass W_{MIN} (t) is to satisfy the requirements of the [Table 3.2.1-5](#).

Table 3.2.1-4 Minimum Allowable Cargo Mass (When the Member Scantling is Determined by the Formula in the Rules)

	Formula Used to Calculate the Minimum Allowable Cargo Mass
Minimum allowable cargo mass (t)	$W_{MIN} \geq \gamma f(h_x)$
The pressure which works on the ship's bottom due to the mass of cargo or ballast water P_{btm} (kN/m^2)	$P_{btm} \geq (-1) \cdot \max(a_1 n_{f1}, a_2 n_{f2}, \dots, a_n n_{fn}) + \rho g T_x + \alpha_{R1} P_{exw1} - \rho g h_{BST}$
Note: P_{btm} , γ , $f(h_x)$, h_x , a_i , n_{fi} , T_x , α_{R1} , P_{exw1} , h_{BST} : As specified in Table 3.2.1-2 .	

Table 3.2.1-5 Minimum Allowable Cargo Mass (When Performing a Strength Assessment by Cargo Hold Analysis)

	Formula Used to Calculate the Minimum Allowable Cargo Mass
Minimum allowable cargo mass (t)	$W_{MIN} \geq \gamma f(h_x)$
The pressure which works on the ship's bottom due to the mass of cargo or ballast water P_{btm} (kN/m^2)	$P_{btm} \geq \min(a_1, a_2, \dots, a_n) + \rho g T_x + \alpha_{R2} P_{exw1} - \rho g h_{BST}$
Notes: P_{btm} , γ , $f(h_x)$, h_x , α_{R2} , P_{exw1} , h_{BST} : As specified in Table 3.2.1-3 . a_i : Difference in pressure (kN/m^2) in loading condition No. i taken from the total of n loading conditions, which works on the centre line of the ship's bottom due to the mass of cargo, ballast water and/or double bottom contents and by wave and still water corresponding to the draught, which is obtained from the following formula with the downward load as a positive value. However, the a_i value must be calculated so the absolute value of a_i does not exceed the design pressure given to the local structural member of the double bottom where the member is reinforced to enable the ship to carry heavy cargoes such as steel coils. $a_i = \min(p_i - (\rho g T_i + P_{exw1}), p_i - (\rho g T_i - P_{exw1}))$ p_i , T_i : As specified Table 3.2.1-3 .	

3 Notwithstanding the requirements of -1 and -2 above, when performing investigations in detail such as investigations based on conditions the loading condition including the conditions specified in **Chapter 4** in strength assessments by cargo hold analysis specified in **Chapter 8** and **Chapter 8, Part 1**, the relationship between the allowable cargo mass and the draught may be determined based on the results of said investigations.

3.2.1.3 Relationship Between the Maximum Allowable Cargo Mass, Minimum Required Cargo Mass, and the Average Draught in Two Adjacent Cargo Holds

1 When including the relationship between the draught and the maximum allowable cargo mass in the loading manual in applying **3.2.1.1-1(4)**, the maximum allowable cargo mass W_{MAX} in two adjacent cargo holds is to be given by the following (1) and (2) as a function of the draught of each cargo hold.

- (1) When the member scantling of the double bottoms structure is determined based on requirements of **Chapter 6, Part 1** and **Chapter 7, Part 1**, the maximum allowable cargo mass W_{MAX} (t) is to satisfy the requirements of the **Table 3.2.1-6**.
- (2) When performing strength assessment of the double bottoms structure based on requirements of **Chapter 8** and **Chapter 8, Part 1**, the maximum allowable cargo mass W_{MAX} (t) is to satisfy the requirements of the **Table 3.2.1-7**.

Table 3.2.1-6 Maximum Allowable Cargo Mass (When the Member Scantling is Determined by the Formula in the Rules)

	Formula used to calculate the maximum allowable cargo mass
Maximum allowable cargo mass (t)	$W_{MAX} \leq \gamma f_1(h_x) + \gamma' f_2(h'_x)$
The pressure which works on the ship's bottom due to the mass of cargo or ballast water in the cargo hold P_{btm1} (kN/m^2)	$P_{btm1} \leq b + \rho g T_x - \alpha_{R1} P_{exw1} - \rho g h_{BST}$
The pressure P_{btm2} (kN/m^2) which works on the ship's bottom due to the mass of cargo or ballast water in adjacent cargo holds	$P_{btm2} \leq b' + \rho g T_x - \alpha_{R1} P_{exw1} - \rho g h'_{BST}$
Notes: P_{btm1}, P_{btm2} : As given by the following formulae: $P_{btm1} = \gamma g h_x$ $P_{btm2} = \gamma' g h'_x$ γ, γ' : The cargo hold with the largest design cargo density (t/m^3) in its loading condition between the cargo hold in question and the adjacent cargo hold when two adjacent cargo holds are loaded simultaneously $f(h_x), f_2(h'_x)$: The function which shows the relationship between the stowage height h_x (m) of cargo at the centre line and the volume (m^3) of cargo loaded in the hold for each cargo hold. In this case, the cargo may be assumed to be loaded uniformly with a level surface. h_x, h'_x : Stowage height (m) to the cargo surface from the top of the inner bottom at the centre line in each cargo hold, to be equal to or less than the height to the upper deck. b, b' : When the relationship between a_j and a'_j is satisfied based on the following formula, and b and b' use the absolute value of a_j and a'_j , respectively. The difference in pressure cannot, however, exceed the design pressure given to the local structural member of the double bottom where the member is reinforced to enable the ship to carry heavy cargoes such as steel coils. $a_j a'_j = \max(a_1 a'_1, a_2 a'_2, \dots, a_m a'_m)$ a_j, a'_j : Differences in pressure (kN/m^2) of the considered hold and the adjacent hold in loading condition No. j taken from the total of m loading conditions such that two adjacent holds are empty or loaded simultaneously, which work on the centre line of the ship's bottom due to the mass of cargo, ballast water and/or double bottom contents and by wave and still water corresponding to the draught. In this case, in loading condition No. j , when the hydrodynamic pressure is added to, or subtracted from, the hydrostatic pressure, the difference in pressure may only be taken into consideration when the pressure difference in the cargo hold in question and the adjacent hold have the same sign (i.e. plus or minus). However, if the pressure difference is of the same sign when hydrodynamic pressure is added to, or subtracted from, the hydrostatic pressure, the values of a_j and a'_j are to be a_{jk} and a'_{jk} to satisfy the following relationships, respectively. $a_{jk} a'_{jk} = \max(a_{j1} a'_{j1}, a_{j2} a'_{j2})$ a_{jk}, a'_{jk} : In loading condition No. j , the pressure difference between the cargo hold in question and the adjacent cargo hold when hydrodynamic pressure is added to the hydrostatic pressure is to be a_{j1} and a'_{j1} , and the pressure difference between the cargo hold in question and the adjacent cargo hold when hydrodynamic pressure is subtracted from the hydrostatic pressure is to be a_{j2} and a'_{j2} . Each is to be determined according to the following formula. $a_{j1} = p_j - (\rho g T_j + P_{exw1})$ $a'_{j1} = p'_j - (\rho g T'_j + P_{exw1})$ $a_{j2} = p_j - (\rho g T'_j - P_{exw1})$ $a'_{j2} = p'_j - (\rho g T'_j - P_{exw1})$ P_{exw1} : As specified in Table 3.2.1-2 . p_j, p'_j : The pressures (kN/m^2) in the considered hold and in the adjacent hold which arise at the centre line of the ship's bottom due to the mass of cargo, ballast water and/or double bottom contents in loading condition No. j T_j, T'_j : Draught (m) at mid-hold position of cargo hold length of the considered hold and the adjacent hold respectively in loading condition No. j	

T_x : The average value (m) of T_j and T'_j
 α_{R1} : As specified in **Table 3.2.1-2**.
 h_{BST} , h'_{BST} : Water heads (m) of ballast water charged in the double bottom at the centre line in each cargo hold. Note, however, that the value does not need to be equal to or greater than the height of the double bottom.

Table 3.2.1-7 Maximum Allowable Cargo Mass (When Performing a Strength Assessment by Cargo Hold Analysis)

	Formula used to calculate the maximum allowable cargo mass
Maximum allowable cargo mass (t)	$W_{MAX} \leq \gamma f_1(h_x) + \gamma' f_2(h'_x)$
The pressure which works on the ship's bottom due to the mass of cargo or ballast water in the cargo hold P_{btm1} (kN/m^2)	$P_{btm1} \leq b + \rho g T_x - \alpha_{R2} P_{exw1} - \rho g h_{BST}$
The pressure which works on the ship's bottom due to the mass of cargo or ballast water in adjacent cargo holds P_{btm2} (kN/m^2)	$P_{btm2} \leq b' + \rho g T_x - \alpha_{R2} P_{exw1} - \rho g h'_{BST}$
Notes: P_{btm1} , P_{btm2} , γ , γ' , $f_1(h_x)$, $f_2(h'_x)$, h_x , h'_x , h_{BST} , h'_{BST} , T_x : As specified in Table 3.2.1-6 . b , b' : As specified in Table 3.2.1-6 . When calculating a_{j1} , a'_{j1} , a_{j2} and a'_{j2} , use the following formula for each. $a_{j1} = p_j - (\rho g T_j + P_{exw2})$ $a'_{j1} = p'_j - (\rho g T_j + P_{exw2})$ $a_{j2} = p_j - (\rho g T_j - P_{exw2})$ $a'_{j2} = p'_j - (\rho g T_j - P_{exw2})$ p_j , p'_j : As specified in Table 3.2.1-6 . In calculating the pressure due to cargo, the density of the cargo and the shape of the cargo surface which were applied in strength assessment by cargo hold analysis may be considered. T_j , T'_j : As specified in Table 3.2.1-6 . P_{exw1} : As specified in Table 3.2.1-2 . α_{R2} : As specified in Table 3.2.1-3 .	

2 When including the relationship between the draught and the allowable cargo mass in the loading manual in applying **3.2.1.1-1(4)**, the minimum allowable cargo mass in two adjacent cargo holds W_{MIN} is to be given by the following **(1)** and **(2)** as a function of the draught of each cargo hold.

- (1) When the member scantling of the double bottoms structure is determined based on requirements of **Chapter 6, Part 1** and **Chapter 7, Part 1**, the minimum allowable cargo mass W_{MIN} (t) is to satisfy the requirements of the **Table 3.2.1-8**.
- (2) When performing a strength assessment of the double bottoms structure based on requirements of **Chapter 8 and Chapter 8, Part 1**, the maximum allowable cargo mass W_{MIN} (t) is to satisfy the requirements of the **Table 3.2.1-9**.

Table 3.2.1-8 Minimum Allowable Cargo Mass (When the Member Scantling is Determined by the Formula in the Rules)

	Formula used to calculate the minimum allowable cargo mass
Minimum allowable cargo mass (t)	$W_{MIN} \geq \gamma f_1(h_x) + \gamma' f_2(h'_x)$
The pressure which works on the ship's bottom due to the mass of cargo or ballast water in the cargo hold P_{btm1} (kN/m^2)	$P_{btm1} \geq -b + \rho g T_x + \alpha_{R1} P_{exw1} - \rho g h_{BST}$
The pressure which works on the ship's bottom due to the mass of cargo or ballast water in adjacent cargo holds P_{btm2} (kN/m^2)	$P_{btm2} \geq -b' + \rho g T_x + \alpha_{R1} P_{exw1} - \rho g h'_{BST}$
<p>Note:</p> <p>P_{btm1}, P_{btm2}, γ, γ', $f(h_x)$, $f_2(h'_x)$, h_x, h'_x, b, b', T_x, α_{R1}, P_{exw1}, h_{BST}, h'_{BST}: As specified in Table 3.2.1-6.</p>	

Table 3.2.1-9 Minimum Allowable Cargo Mass (When Performing a Strength Assessment by Cargo Hold Analysis)

	Formula used to calculate the minimum allowable cargo mass
Minimum allowable cargo mass (t)	$W_{MAX} \geq \gamma f_1(h_x) + \gamma' f_2(h'_x)$
The pressure which works on the ship's bottom due to the mass of cargo or ballast water in the cargo hold P_{btm1} (kN/m^2)	$P_{btm1} \geq b + \rho g T_x + \alpha_{R2} P_{exw1} - \rho g h_{BST}$
The pressure which works on the ship's bottom due to the mass of cargo or ballast water in adjacent cargo holds P_{btm2} (kN/m^2)	$P_{btm2} \geq b' + \rho g T_x + \alpha_{R2} P_{exw1} - \rho g h'_{BST}$
Notes: P_{btm1} , P_{btm2} , γ , γ' , $f(h_x)$, $f_2(h'_x)$, h_x , h'_x , h_{BST} , h'_{BST} , T_x , P_{exw1} , α_{R2} : As specified in Table 3.2.1-7 . b , b' : When the relationship between a_j and a'_j is satisfied, b and b' shall be a_j and a'_j , respectively. However, the b and b' value are to be calculated so the absolute values of b and b' do not exceed the design pressure given to the local structural member of the double bottom where the member is reinforced to enable the ship to carry heavy cargoes such as steel coils. $ a_j a'_j = \min(a_1 a'_1, a_2 a'_2, \dots, a_m a'_m)$ a_j , a'_j : Differences in pressure (kN/m^2) of the considered hold and the adjacent hold in loading condition No. j taken from the total of m loading conditions such that two adjacent holds are empty or loaded simultaneously, which work on the centre line of the ship's bottom due to the mass of cargo, ballast water and/or double bottom contents and by wave and still water corresponding to the draught. In this case, in loading condition No. j , when the wave fluctuation pressure is added to, or subtracted from, the hydrostatic pressure, the difference in pressure may only be taken into consideration when the pressure difference in the cargo hold in question and the adjacent hold have the same sign (i.e. plus or minus). However, if the pressure difference is of the same sign when wave fluctuation pressure is added to, or subtracted from, the hydrostatic pressure, the values of a_j and a'_j are to be a_{jk} and a'_{jk} to satisfy the following relationships, respectively. $ a_{jk} a'_{jk} = \min(a_{j1} a'_{j1}, a_{j2} a'_{j2})$ a_{jk} , a'_{jk} : In loading condition No. j , the pressure difference between the cargo hold in question and the adjacent cargo hold when hydrodynamic pressure is added to the hydrostatic pressure are to be a_{j1} and a'_{j1} , and the pressure difference between the cargo hold in question and the adjacent cargo hold when wave fluctuation pressure is subtracted from the hydrostatic pressure shall be a_{j2} and a'_{j2} , with each calculated by the following formula. $a_{j1} = p_j - (\rho g T_j + P_{exw1})$ $a'_{j1} = p'_j - (\rho g T_j + P_{exw1})$ $a_{j2} = p_j - (\rho g T_j - P_{exw1})$ $a'_{j2} = p'_j - (\rho g T_j - P_{exw1})$ p_j , p'_j : As specified in Table 3.2.1-7 . In calculating the pressure due to cargo, the density of the cargo and the shape of the cargo surface which were applied in strength assessment by cargo hold analysis may be taken into consideration. T_j , T'_j : As specified in Table 3.2.1-7 .	

3 Notwithstanding the requirements of -1 and -2 above, when performing investigations in detail such as investigations based on conditions the loading condition including the conditions specified in **Chapter 4** in strength assessments by cargo hold analysis specified in **Chapter 8** and **Chapter 8, Part 1**, the relationship between the allowable cargo mass and the draught may be determined based on the results of said investigations.

3.2.2 Loading Instruments

3.2.2.1 Additional Requirements for the Loading Instruments

1 In applying **3.8.3, Part 1**, the following items are to be confirmed to be within their allowable limits for ships with L_f of 150 m or more.

- (1) Relationship of the draught and the load capacity when the maximum allowable and minimum required mass of cargo and double bottom contents of each hold as a function of the draught at mid-hold position are given as design conditions.

- (2) Relationship of the draught and the load capacity when the maximum allowable and minimum required mass of cargo and double bottom contents of any two adjacent holds as a function of the mean draught of two adjacent cargo holds are given as design conditions.
 - (3) For ships for which **Annex 1.1, Chapter 1 of Part 2-2 “Additional Requirements for Bulk Carriers in Chapter XII of the SOLAS Convention”** applies, include the vertical still water bending moment and the vertical shear force in still water listed as listed in the requirement requirements of the annex.
- 2** The requirements of **3.8.3, Part 1** are to be applied concerning the vertical still water bending moment and the vertical shear force in still water during flooding as specified in **-1(3)** above.

Chapter 4 LOADS

4.1 General

4.1.1 Overview

4.1.1.1 Relationship to Chapter 4 in Part 1

Each section of this Chapter defines the additional requirements shown in **Table 4.1.1-1** as the loads used for each formula and each strength assessment to determine the structural dimensions specified in each Chapter of **Part 2-3** and **Part 1**.

Table 4.1.1-1 Overview of Chapter 4

Section	Title	Overview
4.1	General	Requirements for the general principles of Chapter 4
4.2	Loads to be Considered in Local Strength	Additional requirements for loads to be considered in the local strength requirements specified in Chapter 6, Part 1 .
4.3	Loads to be Considered in Strength Assessment by Cargo Hold Analysis	Additional requirements for loading condition, etc. to be considered in the requirements for strength assessment by cargo hold analysis specified in Chapter 8 and Chapter 8, Part 1 .
4.4	Loads to be Considered in Fatigue	Additional requirements for loads to be considered in the fatigue strength assessment requirements specified in Chapter 9 and Chapter 9, Part 1 .

4.2 Loads to be Considered in Local Strength

4.2.1 General

4.2.1.1 General

1 The loads to be considered in the local strength requirements specified in **Chapter 6, Part 1** are also to be in accordance with the requirements of **4.2**.

2 Additional requirements for loads in the maximum load condition are to be in accordance with the requirements of **4.2.2**.

4.2.2 Maximum Load Condition

4.2.2.1 General

1 In applying **4.4.2, Part 1**, the cargo mass and cargo density to be considered are to be in accordance with **Table 4.2.2-1** instead of the requirements of **Table 4.4.2-10, Part 1**. The parameters (GM , z_G , etc.) required to calculate the dynamic pressure due to cargo is to be the values in the appropriate loading condition of the full load condition. However, the values in **Table 4.2.2-2** may be used if the values are not applicable.

2 In applying **4.4.2, Part 1**, the parameters (GM , z_G etc.) required to calculate the dynamic pressure due to ballast water is to be the values in the ballast condition. The same parameters are to be applied where the dynamic pressure due to liquid other than ballast water, such as the pressure due to fuel oil tank, is calculated. However, the values in **Table 4.2.2-2** may be used if the values are not applicable.

Table 4.2.2-1 Mass and Density of Ore Cargo

	When cargo is loaded up to the top of the hatch coaming	Circumstances other than those described on the left (when loading high density ore cargo, etc.)
Mass of the ore cargo to be considered $M(t)$	M_D	M_D
Cargo density ρ_C (t/m^3)	$\frac{M_D^{(1)}}{V_{Full}}$	3.0
Notes:		
M_D : Maximum allowable cargo mass (t) in the cargo hold to be considered		
V_{Full} : Volume of cargo hold including hatch coaming section (m^3)		
(1) It is not to be less than 1.0.		

Table 4.2.2-2 Simple Formulae for Parameters

Loading condition	Draught T_{LC} (m) amidships	Z coordinate z_G (m) of the centre of gravity of the ship	Metacentric height $GM(m)$	Radius of gyration K_{xx} (m)
Full load condition	T_{SC}	$0.25 \frac{B}{C_B}$	$\frac{T_{SC}}{2} + \frac{B^2}{T_{SC} C_B} \frac{3C_W - 1}{24} - z_G$	$0.25B$
Ballast condition	T_{BAL}	$0.20 \frac{B}{C_{B,LC}}$	$\frac{T_{LC}}{2} + \frac{B^2}{T_{LC} C_{B,LC}} \frac{3C_{W,LC} - 1}{24} - z_G$	$0.40B$

4.3 Loads to be Considered in Strength Assessment by Cargo Hold Analysis

4.3.1 General

4.3.1.1 General

1 The loads to be considered in the requirements of strength assessments by the cargo hold analysis specified in **Chapter 8** and **Chapter 8, Part 1** are also to be in accordance with the requirements of **4.3**.

2 Additional requirements for loads in the maximum load condition are to be in accordance with the requirements of **4.3.2**.

3 Additional requirements for loads in the harbour condition are to be in accordance with the requirements of **4.3.3**.







4.3.2 Maximum Load Condition



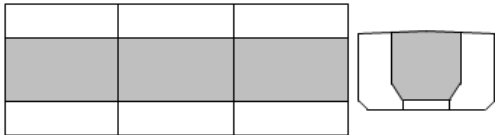
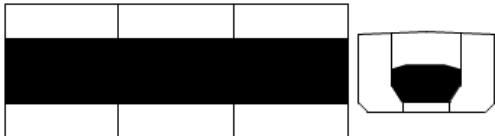

4.3.2.1 Loading Conditions

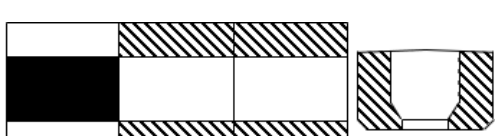
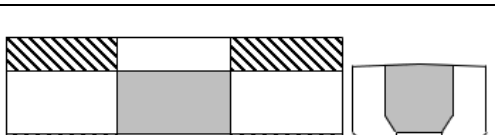
1 In applying **4.6.2.1, Part 1**, the loading conditions specified in **Table 4.3.2-1** are to be considered. However, the loading pattern corresponding to the loading condition that is not allowed in operation may not be considered.

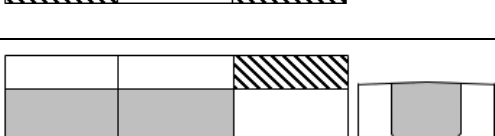
2 Notwithstanding the requirements in -1 above, additional requests may be given to consider the loading conditions specified in the loading manual.

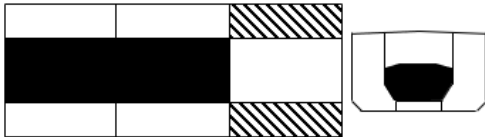
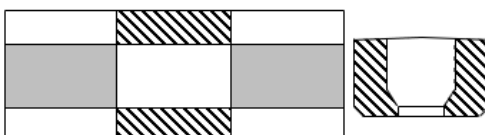
Table 4.3.2-1 Loading Conditions to be Considered in Maximum Load Condition

Loading condition	Loading pattern		Draught	Vertical still water bending moment	Equivalent design wave
Full load condition (homogeneous)	S1		T_{SC}	$0^{(2)}$	HM-2/FM-2
				M_{SV_min}	HM-1/FM-1 BR-1P/S BP-1P/S
	S2		T_{SC}	$0^{(2)}$	HM-2/FM-2
				M_{SV_min}	HM-1/FM-1 BR-1P/S BP-1P/S
Ballast condition	S3		T_{BAL}	M_{SV_max}	HM-2/FM-2
				M_{SV_min}	HM-1/FM-1 BR-1P/S BP-1P/S
	S4		T_{BAL2}	M_{SV_max}	HM-2/FM-2
				M_{SV_min}	HM-1/FM-1 BR-1P/S BP-1P/S
Condition loaded/unloaded in multiple ports ⁽¹⁾	S5		$T_{MP1-max}$	$0.5M_{SV_max}^{(2)}$	HM-2/FM-2
				M_{SV_min}	HM-1/FM-1
	S6		$T_{MP2-max}$	$0.5M_{SV_max}^{(2)}$	HM-2/FM-2
				M_{SV_min}	HM-1/FM-1 BR-1P/S BP-1P/S
	S7		$T_{MP3-min}$	$0.5M_{SV_max}^{(2)}$	HM-2/FM-2
				M_{SV_min}	HM-1/FM-1
	S8		$T_{MP4-min}$	$0.5M_{SV_max}^{(2)}$	HM-2/FM-2
				M_{SV_min}	HM-1/FM-1 BR-1P/S BP-1P/S
S9		$T_{MP5-min}$	$0.5M_{SV_max}^{(2)}$	HM-2/FM-2	
			M_{SV_min}	HM-1/FM-1	

Loading condition	Loading pattern		Draught	Vertical still water bending moment	Equivalent design wave
	S10		$T_{MP6-min}$	$0.5M_{SV,max}^{(2)}$	HM-2/FM-2
				$M_{SV,min}$	HM-1/FM-1 BR-1P/S BP-1P/S
	S11		$T_{MP7-max}$	$0.5M_{SV,max}^{(2)}$	HM-2/FM-2
				$M_{SV,min}$	HM-1/FM-1
	S12		$T_{MP8-max}$	$0.5M_{SV,max}^{(2)}$	HM-2/FM-2
				$M_{SV,min}$	HM-1/FM-1 BR-1P/S BP-1P/S
<p>  : Dry bulk cargo (mass of ore cargo: M_D)  : High density cargo (mass of ore cargo: M_D)  : Ballast water </p>					
<p>Notes:</p> <p>T_{BAL2}: Minimum draught (m) in ballast conditions S4. However, T_{BAL} is to be the lower limit.</p> <p>$T_{MPi-max}$: Maximum draught (m) in multi-port loading/unloading condition i. However, the lower limit is the largest draught in the loading condition including the loading pattern of the multi-port loading/unloading condition i described in the loading manual, and the upper limit is the scantling draught .</p> <p>$T_{MPi-min}$: Minimum draught (m) in multi-port loading/unloading condition i. However, the upper limit is the smallest draught in the loading condition including the loading pattern of the multi-port loading/unloading condition i described in the loading manual.</p>					
<p>(1) The radius of gyration (m) around the X-axis is taken to be $0.325B$. However, the value calculated based on the weight distribution according to the loading condition to be considered can be used.</p> <p>(2) If the vertical still water bending moment in the loading condition under consideration exceeds the value in the table, said moment are to be taken into consideration.</p>					

4.3.2.2 Lateral Loads

In applying **4.6.2.6, Part 1**, the cargo mass and cargo density under consideration are to be in accordance with **Table 4.3.2-2**.

Table 4.3.2-2 Mass and Density of Ore Cargo

	When cargo is loaded up to the top of the hatch coaming	Circumstances other than those described on the left (when loading high density ore cargo, etc.)
Mass of the ore cargo to be considered $M(t)$	M_D	M_D
Cargo density ρ_C (t/m^3)	$\frac{M_D^{(1)}}{V_{Full}}$	3.0
Notes:		
M_D : Maximum allowable cargo mass (t) in the cargo hold to be considered		
V_{Full} : Volume of cargo hold including hatch coaming section (m^3)		
(1) It is not to be less than 1.0.		

4.3.2.3 Hull Girder Loads



In applying **4.6.2.10, Part 1**, the value of M_{SV} is to be replaced with the value specified in **Table 4.3.2-1**.

4.3.3 Harbour Conditions

4.3.3.1 Loading Conditions

In applying **4.6.3.1, Part 1**, the loading conditions specified in **Table 4.3.3-1** are to be considered.

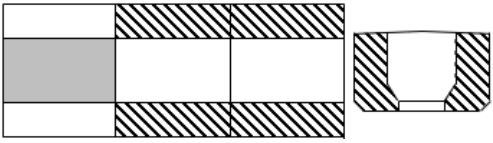
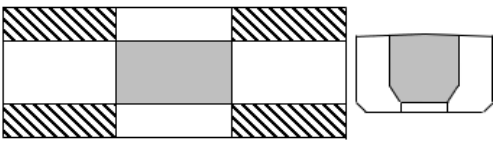
Table 4.3.3-1 Loading Conditions in Harbour Condition

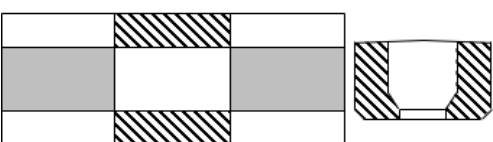
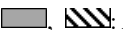
Loading condition	Loading pattern		Draught	Vertical bending moment in harbour
Harbour condition	P1		T_{PT-max}	$0.5M_{PT-max}$
				M_{PT-min}
	P2		T_{PT-min}	$0.5M_{PT-max}$
				M_{PT-min}
	P3		T_{PT-min}	$0.5M_{PT-max}$
				M_{PT-min}
	P4		T_{PT-max}	$0.5M_{PT-max}$
				M_{PT-min}
 As specified in Table 4.3.2-1 .				
Notes: T_{PT-max} : Maximum designed draught in the harbour condition (m). However, the lower limit is the maximum draught and the upper limit is the scantling draught T_{SC} of the loading conditions in harbour condition described in the loading manual. T_{PT-min} : Minimum designed draught in harbour (m) The upper limit is the smallest draught of the loading conditions in harbour condition described in the loading manual.				

4.3.3.2 Hull Girder Loads

In applying [4.6.3.5, Part 1](#), the vertical bending moment in harbour for the loading condition under consideration is to be in accordance with the requirements of [4.3.3.1](#).

4.4 Loads to be Considered in Fatigue

4.4.1 General

4.4.1.1 General

1 The loads to be considered in the fatigue strength assessment specified in [Chapter 9](#) and [Chapter 9, Part 1](#) are also to be in accordance with the requirements of [4.4](#).





2 Additional requirements for loads in the cyclic load condition are to be in accordance with the requirements of [4.4.2](#).

4.4.2 Cyclic Load Condition

4.4.2.1 Loading Conditions

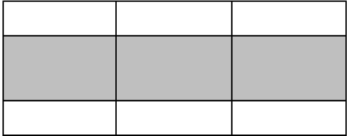
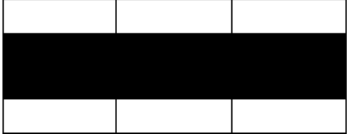
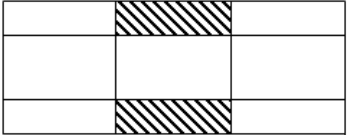
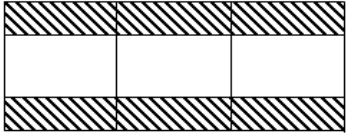
In applying [4.7.2.1, Part 1](#), the loading conditions specified in [Table 4.4.2-1](#) are to be considered. However, where actual condition is different with loading patterns specified in [Table 4.4.2-1](#) because of tank arrangement, etc. loading patterns based upon the loading conditions in the loading manual may be considered.

Table 4.4.2-1 Loading Conditions in Cyclic Load Condition

Loading condition	Loading pattern		Draught	Vertical still water bending moment	Equivalent design wave
Homogeneous full load condition	FA1		T_{SC}	Values in the loading conditions to be considered	HM FM BR BP
	FA2		T_{SC}		
Ballast condition	FA3		T_{BAL}		
	FA4		T_{BAL2}		
<p>, , : As specified in Table 4.3.2-1.</p>					
<p>Notes: T_{BAL2}: As specified in Table 4.3.2-1.</p>					

Chapter 8 STRENGTH ASSESSMENT BY CARGO HOLD ANALYSIS

8.1 General

8.1.1 Overview

8.1.1.1 Structure and Overview of this Chapter

- 1 This Chapter specifies methods for strength assessment by cargo hold analysis in ore carriers.
- 2 The structure and overview of this Chapter are shown in [Table 8.1.1-1](#).

Table 8.1.1-1 Overview of Chapter 8

Section	Title	Overview
8.1	General	Additional requirements related to the overview and application of this Chapter
8.2	Evaluation Area and Members to be Assessed	Additional requirements related to the evaluation areas and members to be assessed
8.3	Structural Models	Additional requirements related to extent of model, members to be modelled, meshing, etc.
8.4	Boundary Conditions and Loads Conditions	Additional requirements related to the boundary conditions and loads conditions
8.5	Strength Assessment	Additional requirements for buckling strength assessment

8.1.2 Application

8.1.2.1 Applicable Ships

Ships that strength assessment by cargo hold analysis is required, which fall under [8.1.2.1-1\(2\), Part 1](#) are to be ships of which the length of L_C is 150 m or more.

8.2 Evaluation Area and Members to be Assessed

8.2.1 Members to be Assessed

8.2.2.1 Members to be Assessed for Maximum Load Condition, Harbour Condition and Testing Condition

In applying [8.2.2.1, Part 1](#), the structures and members to be assessed are to be as follows.

- (1) Double bottom structure (bottom shell, inner bottom plating, centre girder, side girder and floor)
- (2) Wing tank structure (side shell, longitudinal bulkheads, transverse rings in wing tanks and girders)
- (3) Bulkhead structure (including stools and girders in the stools)
- (4) Deck structure (including cross decks)
- (5) Other members deemed necessary by the Society

8.3 Structural Models

8.3.1 General

8.3.1.1 Extent of Model

In applying [8.3.1.1, Part 1](#), the model is, in principle, to represent three adjacent cargo holds with the target hold in the middle and the full depth and the full width of the holds are to be modelled.

8.4 Boundary Conditions and Loads Conditions

8.4.1 Boundary Conditions

8.4.1.1

In applying [8.5.1, Part 1](#), the boundary conditions are to be in accordance with [8.4.1, Part 2-2](#).

8.4.2 Loads Condition

8.4.2.1 Loads to be Considered

In applying [8.5.2, Part 1](#), loads based also upon the additional requirements specified in [4.3](#) are to be considered.

8.4.2.2 Method of Applying Moments to the Structural Model

In applying [8.5.2, Part 1](#), the vertical bending moment and horizontal bending moment act on the target hold are to be adjusted in accordance with the method specified in [8.4.2, Part 2-2](#).

8.5 Strength Assessment

8.5.1 Yield Strength Assessment and Buckling Strength Assessment

8.5.1.1 Strength Assessment of Side Shell in Beam Sea

1 Where strength assessment is performed considering the load based on the equivalent design waves *BR* and *BP* in the maximum load condition, [8.6.2.1-2, Part 1](#) may be applied for stiffened panels of side shell instead of [8.6.2.1-1, Part 1](#) where the compressive stress in the shorter side direction of the panels, which is due to bending deformation of side transverse and side shell, is dominant component (See [Table 8.5.1-1](#)).

2 In application of -1 above, yield strength assessment specified in [8.6.1, Part 1](#) of side shell need not be carried out.

3 In application of -1 above, where the yield strength assessment and buckling strength assessment specified in [An2.7, Annex 8.6A, Part 1 “Strength Assessment Considering Effect of Surrounding Structures”](#) are carried out, the yield strength and buckling strength assessments may not be required for the following (1) to (4).

- (1) Stiffened panels within the rigidity reduction range
- (2) Buckling panels which include elements sharing nodes included in the elements of (1) above
- (3) Plate panels on lower stool plating
- (4) Elements which include (1), (2) and (3) above

8.5.1.2 Strength Assessment of Lower Stool Plating in Beam Sea

1 Where strength assessment is performed considering the load based on the equivalent design waves *BR* and *BP* in the maximum load condition, [8.6.2.1-2, Part 1](#) may be applied for plate panels of lower stool plating instead of [8.6.2.1-1, Part 1](#) (See [Table 8.5.1-1](#)).

2 In application of -1 above, yield strength assessment specified in [8.6.1, Part 1](#) of lower stool plating need not be carried out.

3 In application of -1 above, where the yield strength assessment and buckling strength assessment specified in [An2.7, Annex 8.6A, Part 1 “Strength Assessment Considering Effect of Surrounding Structures”](#) are carried out, the yield strength and buckling strength assessments may not be required for the following plate panels and elements including the panels.

- (1) Plate panels within the region of rigidity reduction

8.5.1.3 Buckling Strength Assessment of Cross Ties in Wing Tanks

In applying [8.6.2, Part 1](#), when assessing the column buckling of cross ties in ore carrier's wing tanks based upon the requirements specified in [An2.5, Annex 8.6, Part 1 “Buckling Strength Assessment based on Cargo Hold Analysis”](#), the cross tie span *l* is to be the distance from the flange of the side stringer attached to the longitudinal bulkhead where the horizontal girder for the cross tie is mounted, to the flange of the side stringer attached to the side shell (See [Table 8.5.1-1](#)). However, if this is difficult to determine based on this definition, the cross-tie span *l* may be determined upon prior consultation with the Society.

8.5.1.4 Buckling Strength Assessment of Cross Deck in Head Sea and Following Sea

Where strength assessment is performed considering the loads based on the equivalent design waves *HM-1* and *FM-1* in the maximum load condition, the assessment specified in [8.6.2.1-1, Part 1](#) may not be carried out for plate panels on cross deck stiffened in transverse direction where the following is satisfied (See [Table 8.5.1-1](#)).

- (1) The stress in longitudinal direction on cross deck due to vertical bending moment is act on the narrow area enough compared

to the length of cross deck in transverse direction.

(2) Thickness of cross deck adjacent to upper deck longitudinally stiffened is greater than 50 % of thickness of the upper deck.

Table 8.5.1-1 Relationship between the Application of Part 1 and Part 2

Member to be assessed	Maximum load condition	
	Equivalent design waves <i>HM</i> and <i>FM</i>	Equivalent design waves <i>BR</i> and <i>BP</i>
Side shell and lower stool plating (Annex 8.6A, Part 1 is applied for equivalent design waves <i>BR</i> and <i>BP</i>)	<ul style="list-style-type: none"> Yield strength assessment: As specified in 8.6.1, Part 1 Buckling strength assessment: As specified in 8.6.2.1-1, Part 1 	<ul style="list-style-type: none"> An2.2 to An2.6 of Annex 8.6A, Part 1 are applied. Permissible utilization factor (buckling): 0.8 Yield strength assessment: <i>NA</i>
Members other than side shell and lower stool plating (Annex 8.6A, Part 1 is applied for equivalent design waves <i>BR</i> and <i>BP</i>)		<ul style="list-style-type: none"> An2.7 of Annex 8.6A, Part 1 is applied. Yield strength assessment: As specified in 8.6.1, Part 1. Buckling strength assessment: As specified in 8.6.2.1-1, Part 1.
Cross deck	<ul style="list-style-type: none"> Yield strength assessment: As specified in 8.6.1, Part 1. Buckling strength assessment: As specified in 8.5.1.4. 	<ul style="list-style-type: none"> Yield strength assessment: As specified in 8.6.1, Part 1. Buckling strength assessment: As specified in 8.6.2.1-1, Part 1.
Cross ties in wing tanks ⁽¹⁾	<ul style="list-style-type: none"> Yield strength assessment: As specified in 8.6.1, Part 1. Buckling strength assessment: As specified in 8.6.2.1-1, Part 1. In addition, as specified in 8.5.1.3. 	
Notes:		
(1) The same requirements apply to harbour condition, testing condition and flooded condition.		

Chapter 9 FATIGUE

9.1 General

9.1.1 Rule Application for Fatigue Requirements

9.1.1.1 Application

Ships with a length L_C of 150 m or more are to be assessed for fatigue strength based on the hot spot stresses obtained by simplified stress analysis according to **9.3, Part 1** and finite element analysis according to **9.4, Part 1**.

9.2 Structural Details to be Assessed

9.2.1 Structural Details to be Assessed by Finite Element Analysis

9.2.1.1

1 Critical structural details to be assessed for fatigue strength by finite element analysis according to **9.4, Part 1**, are shown in **Table 9.2.1-1**.

2 Notwithstanding the requirements specified in -1 above, where documents demonstrating sufficient fatigue strength are submitted and deemed appropriate to the Society, the fatigue strength assessment of the structure may be omitted.

Table 9.2.1-1 Structural Details of Primary Members to be Assessed in the Hull Structure

No.	Critical structural details of hull structure
1	Intersections between bilge hopper plating and inner bottom plating
2	Intersections between bilge hopper plating and inner longitudinal bulkhead
3	Intersections between lower stool and inner bottom plating in way of bottom girder
4	Hatch corner
5	Intersections of lower stool and corrugated bulkheads
6	Intersections between transverse bulkhead horizontal stringer, and side stringer in wing tank
7	Other areas with large stress concentration

9.3 Loading Conditions and Fraction of Time to be Considered

9.3.1 General

9.3.1.1

1 Standard loading conditions and fraction of time are to be in accordance with **Table 9.3.1-1**.

2 Notwithstanding the requirements specified in -1 above, when considering loading conditions and fraction of time other than those in **Table 9.3.1-1**, it is necessary to consider appropriate combinations.

Table 9.3.1-1 Standard Loading Conditions and Fraction of Time

Loading conditions	Fraction of Time $\alpha_{(j)}$
Full load condition (homogeneous loading)	50 %
Ballast condition	50 %

9.4 Boundary Conditions and Load Conditions

9.4.1 Boundary Conditions

9.4.1.1

In applying **9.4.4.1, Part 1**, the boundary conditions are to be in accordance with **8.4.1.1, Part 2-2**.

9.4.2 Load Conditions

9.4.2.1 Method of Applying Moments to the Structural Model

In applying **9.4.4.2, Part 1**, the method of applying moments to the structural model is to be in accordance with **8.4.2.2, Part 2-2**. However, the vertical bending moment and horizontal bending moment ($kN\cdot m$) specified in **Table 9.4.2-1** are to be used as M_{V-targ} and M_{H-targ} instead of those specified in **Table 8.4.2-1, Part 2-2**.

Table 9.4.2-1 M_{V-targ} and M_{H-targ}

	Cyclic load condition
Vertical bending moment M_{V-targ}	M_{V-HG}
Horizontal bending moment M_{H-targ}	M_{H-HG}
Note: M_{V-HG} , M_{H-HG} : Vertical bending moment and horizontal bending moment ($kN\cdot m$) under cyclic load condition, to be in accordance with 4.7.2.10, Part 1 .	

Chapter 10 ADDITIONAL STRUCTURAL REQUIREMENTS

10.1 Bottom Structure

10.1.1 General

10.1.1.1 Drainage of Cargo Holds

1 In general, one bilge suction opening is to be arranged on each side of the ship at the after end of the cargo hold. Where the length of the cargo hold in ships having only one hold exceeds 66 *m*, an additional bilge suction opening is to be arranged in a suitable position in the forward half-length of the hold.

2 Bilge wells are to be arranged at suitable positions so as to protect cover plates from direct contact with the ore. They are to be provided with strum boxes or other suitable means so that the suction openings are not choked by ore dust or other particles.

3 Where bilge pipes are led through double bottoms, side tanks or void spaces, non-return valves or stop valves capable of being closed from a readily accessible position are to be provided at their open ends.

4 Bilge suction branch pipes may be of an inside diameter obtained from the formula in [13.5.3-1, Part D](#), substituting the mean breadth of the ore hold for *B*.

10.2 Side Structure

10.2.1 Primary Structural Members

10.2.1.1 General

Structural details of girders and cross ties are to be in accordance with the following (1) and (2).

- (1) Girders provided within the same plane are to be arranged to avoid sharp changes in strength and rigidity. Brackets of a suitable size are to be provided at the ends of girders, and bracket toes are to be sufficiently rounded.
- (2) Lower brackets of side transverses and transverses on longitudinal bulkheads and web plates in the vicinity of the edge of the brackets are to be effectively stiffened.

10.2.1.2 Bottom Transverses and Deck Transverses

The rigidity of bottom transverses and deck transverses is to be well balanced with that of side transverses

10.2.1.3 Cross Ties

Where side transverses and transverses on longitudinal bulkheads in wing tanks are effectively connected, the structure of the cross ties are to be in accordance with the following (1) and (2).

- (1) Brackets are to be provided at the ends of cross ties to connect cross ties with transverses.
- (2) Where the breadth of face plates forming cross ties exceeds 150 *mm* on one side of the web, stiffeners are to be provided at proper intervals to support the face plates as well.

10.2.1.4 Structural Details

Structural details of transverses and cross ties are to be in accordance with the following (1) to (3).

- (1) Additional stiffeners are to be fitted at end bracket parts, connections with cross ties of transverses, and parts where shearing stress and/or compressive stress are expected to be high. These parts are not to have lightening holes. However, parts that are provided with adequate reinforcements (for example, horizontal girders are to be fitted at cross ties) in order to release stress do not need to be in accordance with these requirements. If considered necessary, slots for penetration of longitudinals in these parts are to be reinforced with collars. Sufficient consideration is to be taken for the continuity of strength at the connection between cross ties and longitudinals (for example, soft brackets are to be provided on the both sides of a transverse).
- (2) When angle bars are used instead of flat bars as stiffeners to be installed on transverses, their moments of inertia with effective plate are to be approximately equivalent to the required ones.
- (3) For structures such as that detailed in [Fig. 10.2.1-1](#), brackets with an asterisk (*) mark are to be installed.

Fig. 10.2.1-1 Connection of Cross Ties

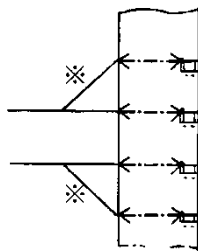

10.3 Deck Structure

10.3.1 Cross Decks

10.3.1.1

Special consideration is to be given to the buckling strength of cross decks.

10.4 Bulkhead Structure

10.4.1 Stools at Transverse Bulkheads in Cargo Holds

10.4.1.1 General

Partial girders, etc. are partially to be arranged beneath the girders in the lower stool of the transverse bulkhead.

10.5 Tank Structures for Sloshing

10.5.1 General

10.5.1.1 Application

1 For the members of ballast tank structures which satisfy the following (1) to (3), the scantlings specified in this 10.5 are considered to be satisfied when obtained using the sloshing loads specified in 4.8.2.4, Part 1.

- (1) Ballast tanks with volumes of not less than 100 m^3
- (2) Ballast tanks designed for possible to loading at filling ratios of not less than 20 % and not more than 90 %
- (3) Where the period of longitudinal oscillation of ballast tanks is within the range of $\pm 20 \%$ of pitch period and within $\pm 1.5 \text{ seconds}$ from the same period, and where the period of transverse oscillation of ballast tanks is within the range of $\pm 20 \%$ of roll period and within $\pm 1.5 \text{ seconds}$ from the same period.

2 In applying -1(3) above, where only one of the conditions is applicable, only the sloshing load due to the relevant ship motion need be considered.

3 In applying -1(3) above, the tank natural periods are to be calculated for each 10 % of the filling ratio, and only the sloshing load due to the filling ratio corresponding to the conditions of -1(3) above need be considered.

10.5.1.2 Scantling Approach

The required scantlings specified in this 10.5 are to be net scantlings.

10.5.2 Plates

10.5.2.1

1 The plate thickness on which sloshing loads act is to be not less than the value obtained from 10.9.2, Part 1.

2 Equivalent pressure for members to be assessed is to be in accordance with Table 10.5.2-1. The density of seawater (1.025 t/m^3), however, is to be considered instead of maximum design cargo density when calculating such pressure.

Table 10.5.2-1 Equivalent Pressure for Plate Panels

Member	P_{slh}
- Transverse bulkheads - Transverse wash bulkheads - Tank top plates near transverse bulkheads ⁽¹⁾	P_{slh-p} (4.8.2.4-4(1), Part 1)
- Longitudinal bulkheads - Side shells - Tank top plates near longitudinal bulkheads / side shells ⁽¹⁾ - Sloping plates below longitudinal bulkheads ⁽²⁾	P_{slh-r} (4.8.2.4-4(2), Part 1)
Notes:	
Numbers in parentheses indicate section number.	
(1) P_{slh-p} is to be applied to the plate panels within the range of $0.3\ell_{tk}$ from transverse bulkheads. In addition, P_{slh-r} is to be applied to the plate panels within the range of $0.3b_{tk}$ from longitudinal bulkheads. The definitions of ℓ_{tk} and b_{tk} are as specified in Table 4.8.2-13 and Table 4.8.2-14, Part 1 .	
(2) For sloping plates below longitudinal bulkheads, sloshing loads are to be calculated using the same parameters as those used for longitudinal bulkheads.	

10.5.3 Stiffeners

10.5.3.1

1 The section modulus of stiffeners attached to plates on which sloshing loads act is to be not less than the value obtained from the formula specified in **10.9.3, Part 1**.

2 Equivalent bending moments for members to be assessed are to be in accordance with **Table 10.5.3-1**. The density of seawater (1.025 t/m^3) is to be considered instead of maximum design cargo density when calculating such moments.

Table 10.5.3-1 Equivalent Bending Moment for Each Member to be Assessed

Member to be assessed	Stiffened system	M_{slh}
- Stiffeners attached to tank top plates ⁽¹⁾	Longitudinal	M_{slh-p} (4.8.2.4-5(1), Part 1) M_{slh-r} (4.8.2.4-5(2), Part 1)
	Transverse	M_{slh-p} (4.8.2.4-5(2), Part 1) M_{slh-r} (4.8.2.4-5(1), Part 1)
- Stiffeners attached to transverse bulkheads - Stiffeners attached to transverse wash bulkheads - Stiffeners attached to vertical girders which are attached to longitudinal bulkheads - Stiffeners attached to horizontal girders which are attached to transverse bulkheads - Stiffeners attached to cross-tie of transverse direction	System A ⁽²⁾	M_{slh-p} (4.8.2.4-5(1), Part 1)
	System B ⁽³⁾	M_{slh-p} (4.8.2.4-5(2), Part 1)
- Stiffeners attached to longitudinal bulkheads - Stiffeners attached to side shells - Stiffeners attached to sloping plates below longitudinal bulkheads - Stiffeners attached to vertical girders which are attached to transverse bulkheads - Stiffeners attached to horizontal girders which are attached to longitudinal bulkheads	System A ⁽²⁾	M_{slh-r} (4.8.2.4-5(1), Part 1)
	System B ⁽³⁾	M_{slh-r} (4.8.2.4-5(2), Part 1)
Notes:		
Numbers in parentheses indicate section number.		

- (1) M_{slh-p} is to be applied to the stiffeners attached to the plate panels within the range of $0.3\ell_{tk}$ from transverse bulkheads. And M_{slh-r} is to be applied to the stiffeners attached to the plate panels within the range of $0.3b_{tk}$ from longitudinal bulkheads / side shells.
- (2) See [Fig. 10.9.3-1, Part 1](#)
- (3) See [Fig. 10.9.3-2, Part 1](#)

10.5.4 Webs of Girders

10.5.4.1

- 1 The web thickness t_w of girders on which sloshing loads act is to be not less than the value obtained from the formula specified in [10.9.4, Part 1](#).
- 2 Equivalent pressure for members to be assessed is to be in accordance with [Table 10.5.4-1](#).

Table 10.5.4-1 Equivalent Pressure for Each Member to be Assessed

Member to be assessed	P_{slh}
<ul style="list-style-type: none"> - Horizontal girders attached to transverse bulkheads / transverse wash bulkheads - Vertical girders attached to longitudinal bulkheads - Vertical girders attached to side shells - Cross-ties in transverse direction 	P_{slh-p} (4.8.2.4-4(1), Part 1)
<ul style="list-style-type: none"> - Horizontal girders attached to longitudinal bulkheads - Vertical girders attached to transverse bulkheads / transverse wash bulkheads - Horizontal girders attached to side shells 	P_{slh-r} (4.8.2.4-4(2), Part 1)
Notes:	
Numbers in parentheses indicate section number.	

10.6 Other

10.6.1 Special Requirements for Ship Intended for the Carriage of Cargoes Having Moisture Contents Which Exceed Transportable Moisture Limit

10.6.1.1

The hull structural members of ships intended for the carriage of cargoes having moisture contents which exceed transportable moisture limit are to be in accordance with the following (1) or (2).

- (1) For ships intended for the carriage of nickel ore with a moisture content that exceeds the transportable moisture limit, the requirements specified in “[Guidelines for the Safe Carriage of Nickel Ore](#)”
- (2) For ships intended for the carriage of cargoes other than nickel ore, evaluation methods deemed appropriate by the Society

Chapter 11 STRUCTURES OUTSIDE THE CARGO REGION

11.1 Superstructures

11.1.1 Forecastles

11.1.1.1

1 Bulk Carriers defined in 1.3.1 (13), Part B, are to be provided with forecastles in accordance with the following (1) to (5). However, the forecastle deck arrangements of ships for which the application of this requirement is, for some reason, difficult are to be at the direction of the Society.

- (1) The forecastle is to be an enclosed superstructure
- (2) The forecastle is to be located on the freeboard deck with its aft bulkhead fitted in way or aft of the forward bulkhead of the foremost hold. (See Fig. 11.1.1-1)
- (3) The forecastle height H_F above the main deck is to be not less than the value given in the following (a) or (b) whichever is the greater:
 - (a) $H_C + 0.5$ (m), where H_C is the height of the forward transverse hatch coaming of the foremost cargo hold.
 - (b) The standard height (m) of superstructure as given in 1.4.3.3, Part 1
- (4) To reduce the load on the hatch coaming of the foremost cargo hold specified in 4.10.2.2-2, Part 1 and/or the pressure applying abaft on the forward transverse hatch cover specified in 4.10.6, Part 1, the horizontal distance l_F (m) from the hatch coaming to all points of the aft edge of the forecastle deck is to satisfy the following formula.

$$l_F \leq 5\sqrt{H_F - H_C}$$

H_F and H_C : As specified in (3) above.

- (5) A breakwater is not to be fitted on the forecastle deck with the purpose of protecting the hatch coaming or hatch covers. If fitted for other purposes, it is to be located such that its aft edge at the centre line is forward of the aft edge of the forecastle deck a horizontal distance l_w (m) satisfying the following formula:

$$l_w \geq H_B / \tan 20^\circ$$

H_B : Height of the breakwater above the forecastle (m)

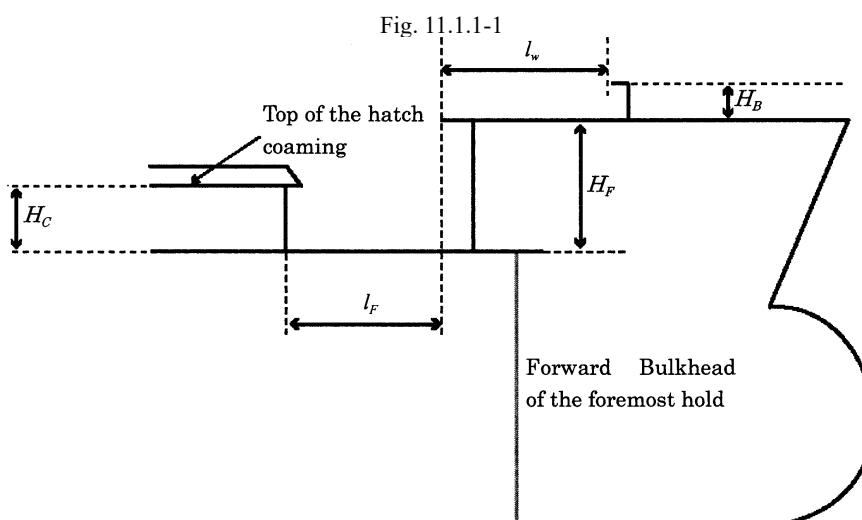

2 Notwithstanding the requirements in -1(2) above, if this requirement hinders hatch cover operation, the aft bulkhead of the forecastle may be fitted forward of the forward bulkhead of the foremost cargo hold provided the forecastle length is not less than 7% of the freeboard length defined in 1.4.3.1-2, Part 1.

Part 2-4 WOOD CHIP CARRIERS

Chapter 1 GENERAL

1.1 General

1.1.1 Application

1.1.1.1 Application of this Part

1 The hull construction and equipment of ships intended to be registered as wood chip carriers affixed with the notation “*Chip Carrier*” (abbreviated as *CPC*), are to be in accordance with the requirements in [Part 2-4](#) in addition to [Part 1](#).

2 The requirements in [Part 2-4](#) are for ships of single-side skin construction having a single deck, double bottom and bilge hopper tanks intended for the carriage of wood chips, and decks and bottoms framed longitudinally.

3 Wood chip carriers with a different construction from that specified in -2 above, to which the requirements in this Part are considered to be not applicable, are to be at the discretion of the Society.

1.1.1.2 Application of Chapter XII of the SOLAS Convention

Wood chip carriers to which [Part 2-4](#) applies are to comply with the [Annex 1.1 in Chapter 1 of Part 2-2](#) “**Additional Requirements for Bulk Carriers in Chapter XII of the SOLAS Convention**”.

1.2 Definitions

1.2.1 Naming Convention

1.2.1.1 Structural Nomenclature

[Fig. 1.2.1-1](#) show the common structural nomenclature used in [Part 2-4](#).

Fig. 1.2.1-1 Chip Carriers

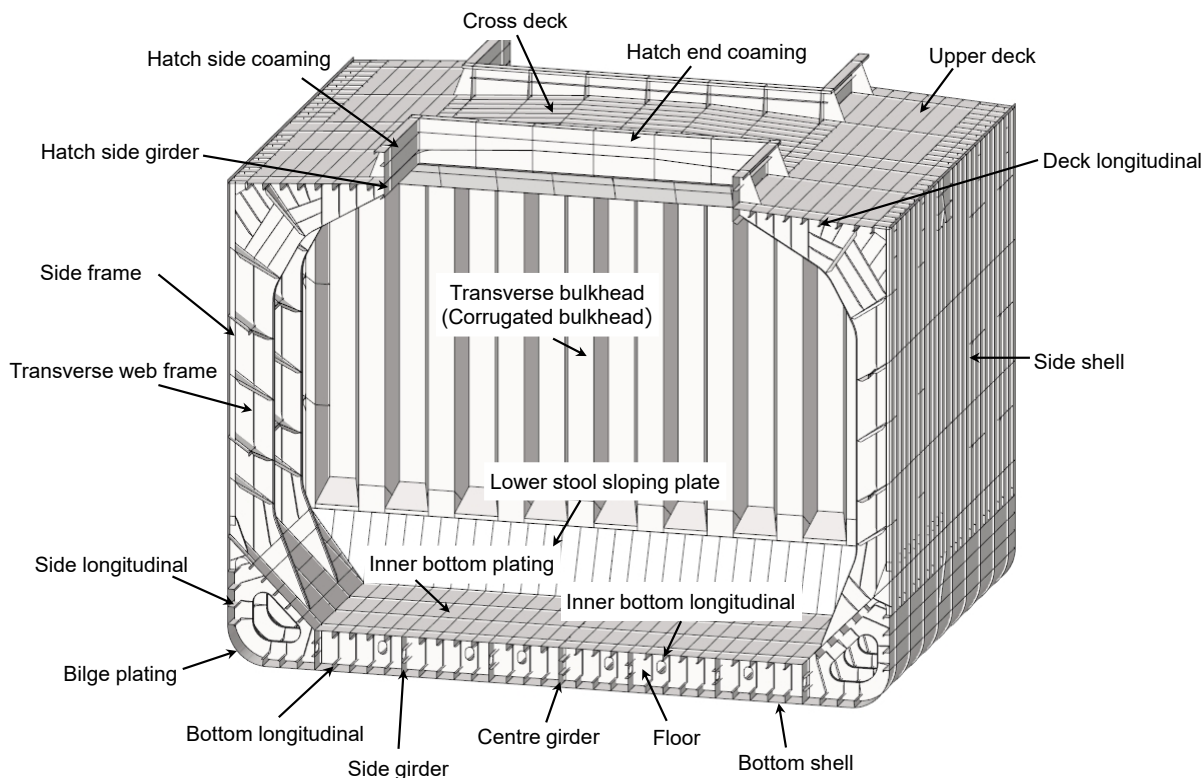

Chapter 2 GENERAL ARRANGEMENT DESIGN

2.1 Structural Arrangements

2.1.1 Double Bottoms

2.1.1.1 Arrangement and Construction of Centre Girder and Side Girder

1 Unless particularly approved by the Society, the height of the centre girder is not to be less than that obtained from the following formula. In ships having unusually large freeboards according to **1.4.3.5, Part 1**, the height of centre girders may be reduced to the values obtained using the depth to the assumed freeboard deck D' instead of D in the formula. However, this height is not to be less than $B/20$ in any circumstance.

$$15 \sqrt{\frac{L_H B D}{m}} (mm)$$

L_H : Total length (m) of all cargo holds, excluding pump rooms and cofferdams

m : Number of holds included in the cargo space

2.1.2 Bilge Hopper Tanks

2.1.2.1 General

When bilge hopper tanks are installed, the arrangement is to be in accordance with the following (1) to (3).

- (1) Compartments of bilge hopper tanks are to be in coincidence with those of holds as far as practicable.
- (2) In bilge hopper tanks, a transverse web is to be provided at every floor.
- (3) Side girders are to be provided at the inner ends of bilge hoppers.

Chapter 3 STRUCTURAL DESIGN PRINCIPLES

3.1 Minimum Requirements

3.1.1 Minimum Thicknesses

- 1 The thickness of webs and upper/lower brackets of side frames is not to be less than that obtained from the following formula.

$$t = 0.03L_{C200} + 3.0 \text{ (mm)}$$

L_{C200} : The length of the ship (m) specified in [1.4.2.2, Part 1](#).

- 2 The thickness of side shell plating located between deck and bilge hopper tanks is not to be less than that obtained from the following formula:

$$t = 0.8\sqrt{L_C} \text{ (mm)}$$

L_C : The length of the ship (m) specified in [1.4.3.1, Part 1](#).

3.2 Loading Manual and Loading Instruments

3.2.1 Loading Manual

3.2.1.1 Additional Requirements for the Loading Manual

In applying the requirements of [3.8.2, Part 1](#), the requirements of [3.2.1, Part 2-2](#) are also to be followed.

3.2.2 Loading Computer

3.2.2.1 Additional Requirements for the Loading Instruments

In applying the requirements of [3.8.3, Part 1](#), the requirements of [3.2.2, Part 2-2](#) are also to be followed.

Chapter 4 LOADS

4.1 General

4.1.1 Overview

4.1.1.1 Structure and Overview of this Chapter

Each section of this Chapter defines the additional requirements shown in **Table 4.1.1-1** as the loads used for each formula and each strength assessment to determine the structural dimensions specified in each Chapter of **Part 2-4** and **Part 1**.

Table 4.1.1-1 Overview of Chapter 4

Section	Title	Overview
4.1	General	Requirements for the general principles of Chapter 4
4.2	Loads to be Considered in Local Strength	Additional requirements for loads to be considered in the local strength requirements specified in Chapter 6 and Chapter 6, Part 1 .
4.3	Loads to be Considered in Strength Assessment by Cargo Hold Analysis	Additional requirements for loads to be considered in the requirements for strength assessment by cargo hold analysis specified in Chapter 8 and Chapter 8, Part 1 .
4.4	Loads to be Considered in Fatigue	Additional requirements for loads to be considered in the fatigue strength assessment requirements specified in Chapter 9 and Chapter 9, Part 1 .

4.2 Loads to be Considered in Local Strength

4.2.1 General

4.2.1.1 General

1 The loads to be considered in the local strength requirements specified in **Chapter 6** and **Chapter 6, Part 1** are also to be in accordance with the requirements of **4.2**.

2 Additional requirements for loads in the maximum load condition are to be in accordance with the requirements of **4.2.2**.

4.2.2 Maximum Load Condition

4.2.2.1 Lateral Loads

1 The cargo mass and cargo density to be considered are to be in accordance with **Table 4.2.2-1** instead of the requirements of **4.4.2.5, Part 1**. For ships designed to carry cargo other than wood chips, the effect due to the cargo is to be appropriately considered. In addition, if necessary, restrictions on cargo density and cargo loading height are to be stated in the loading manual.

2 In applying **4.4.2, Part 1**, the parameters (GM , z_G , etc.) required to calculate dynamic pressure due to cargo are to be the values in the full load condition. However, the values in **Table 4.2.2-2** may be used if the parameters are not available.

3 In applying **4.4.2, Part 1**, the parameters (GM , z_G , etc.) required to calculate the dynamic pressure due to ballast water are to be the values in the heavy ballast condition. The same parameters are to be applied where the dynamic pressure due to liquid other than ballast water, such as the pressure due to fuel oil tank, is considered. However, the values in **Table 4.2.2-2** may be used if the parameters are not available.

Table 4.2.2-1 Mass and Density of Wood Chip Cargo

Wood chip mass to be considered M (t)	M_D
Cargo density ρ_C (t/m^3)	$\frac{M_D}{V_{Full}}$
Notes: M_D : Maximum allowable wood chip mass in the cargo hold to be considered (t) V_{Full} : Volume of cargo hold including hatch coaming (m^3)	

Table 4.2.2-2 Simple Formulae for Parameters

Loading condition	Draught T_{LC} (m) amidships	Z coordinate z_G (m) of the centre of gravity of the ship	Metacentric height $GM(m)$	Radius of gyration K_{xx} (m)
Full load condition	T_{SC}	$0.25 \frac{B}{C_B}$	$\frac{T_{SC}}{2} + \frac{B^2}{T_{SC} C_B} \frac{3C_W - 1}{24} - z_G$	$0.35B$
Heavy ballast condition	T_{BAL-H}	$0.20 \frac{B}{C_{B_LC}}$	$\frac{T_{LC}}{2} + \frac{B^2}{T_{LC} C_{B_LC}} \frac{3C_{W_LC} - 1}{24} - z_G$	$0.40B$

4.3 Loads to be Considered in Strength Assessment by Cargo Hold Analysis

4.3.1 General

4.3.1.1 General

1 The loads to be considered in the strength assessment by the cargo hold analysis specified in [Chapter 8](#) and [Chapter 8, Part 1](#) are also to be in accordance with the requirements of [4.3](#).

2 Additional requirements for loads in the maximum load condition are to be in accordance with the requirements of [4.3.2](#).

3 Additional requirements for loads in the maximum load condition are to be in accordance with the requirements of [4.3.3](#).

4.3.2 Maximum Load Condition

4.3.2.1 Loading Conditions

1 In applying [4.6.2.1, Part 1](#), in addition to the homogeneous full load condition and ballast condition, for ships designed for loaded/unloaded in multiple ports, the corresponding conditions are to be considered from the loading condition specified in [Table 4.3.2-1](#). For ballast hold, the loading conditions specified in [Table 4.3.2-2](#) are to be additionally considered. However, the loading pattern corresponding to the loading condition that is not restricted in operation may not be considered.

2 As for ships designed to carry cargo other than wood chips, the Society may require appropriate consideration of the effect due to the cargo density and cargo height restrictions specified in the loading manual.

3 Notwithstanding the requirements in -1 above, the Society may require considering loading conditions specified in the loading manual additionally where deemed necessary.

Table 4.3.2-1 Loading Conditions to be Considered in Maximum Load Condition (Other than the Ballast Hold)







Loading condition ⁽¹⁾	Loading pattern		Draught	Vertical still water bending moment ⁽³⁾	Equivalent design wave
Homogeneous full load condition	S1		T_{SC}	$0.5M_{SV_max}$	HM-2/FM-2
				$0.5M_{SV_min}$	HM-1/FM-1 BP-1P/S BR-1P/S
Ballast condition ⁽²⁾	S2		T_{BAL}	M_{SV_max}	HM-2/FM-2
				M_{SV_min}	HM-1/FM-1 BP-1P/S BR-1P/S
Condition loaded/unloaded in multiple ports	S3		$T_{MP1-max}$	M_{SV_max}	HM-2/FM-2
				M_{SV_min}	HM-1/FM-1
	S4		$T_{MP2-min}$	M_{SV_max}	HM-2/FM-2
				M_{SV_min}	HM-1/FM-1
	S5		$T_{MP3-min}$	M_{SV_max}	HM-2/FM-2
				M_{SV_min}	HM-1/FM-1
	S6		$T_{MP4-max}$	M_{SV_max}	HM-2/FM-2
				M_{SV_min}	HM-1/FM-1
<p>: Dry bulk cargo (mass of wood chip cargo: M_D)</p> <p>: Ballast water</p>					
<p>Notes:</p> <p>$T_{MPi-max}$: Maximum draught in multi-port loading/unloading condition i (m). However, the lower limit is the largest draught in the loading condition including the loading pattern i of the multi-port loading/unloading condition described in the loading manual, and the upper limit is the scantling draught T_{SC}.</p> <p>$T_{MPi-min}$: Minimum draught in multi-port loading/unloading condition i (m). However, the upper limit is the smallest draught in the loading condition including the loading pattern i of the multi-port loading/unloading condition described in the loading manual.</p>					
<p>(1) The radius of gyration (m) around the X-axis, to be taken as $0.35B$ in the homogeneous full load condition, to be taken as $0.40B$ in the ballast condition, and to be taken as $0.38B$ in the multi-port loading/unloading condition. However, the value calculated based on the weight distribution according to the loading condition to be considered may be used.</p> <p>(2) If the ballast tank is partially filled or empty by design, strength assessments are to be carried out with the ballast tank empty to account for ballast conditions. When performing strength assessments with fully loaded ballast tank to account for ballast conditions, the loading manual are to note that the ballast tank is to be kept fully loaded at all times as an operational restriction.</p> <p>(3) In the multi-port loaded/unloaded condition, instead of the vertical still water bending moment specified in the table, the maximum or minimum vertical still water bending moment that occurs after considering all possible physical combinations such as a full or empty consumable tank may be considered.</p>					

Table 4.3.2-2 Loading Conditions to be Considered in Maximum Load Condition (Additional Requirements for the Ballast Hold)

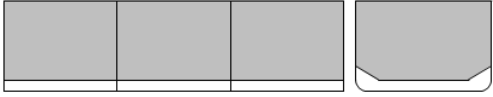
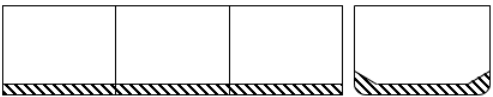
Loading condition ⁽¹⁾	Loading patterns ⁽²⁾		Draught	Vertical still water bending moment	Equivalent design wave
Heavy ballast condition	S2a		T_{BAL-H}	M_{SV_max}	HM-2/FM-2
				M_{SV_min}	HM-1/FM-1 BP-1P/S BR-1P/S
	S2b		T_{BAL-H}	M_{SV_max}	HM-2/FM-2
				M_{SV_min}	HM-1/FM-1 BP-1P/S BR-1P/S
 : As specified in Table 4.3.2-1 .					
Notes: (1) The radius of gyration (m) around the X -axis is taken to be $0.40B$. However, the value calculated based on the weight distribution according to the loading condition to be considered can be used. (2) If the ballast tank under ballast hold is partially filled or empty by design, strength assessments are to be carried out with the ballast tank empty to account for ballast conditions. When performing strength assessments with fully loaded ballast tank to account for ballast conditions, the loading manual are to note that the ballast tank is to be kept fully loaded at all times as an operational restriction.					

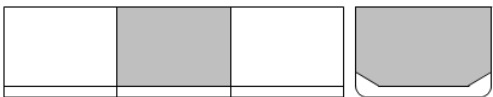
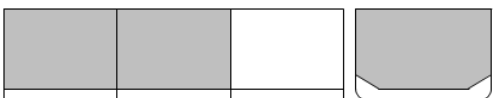
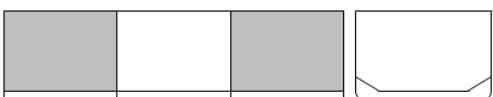
4.3.2.2 Internal Pressure Due to Wood Chip Cargo

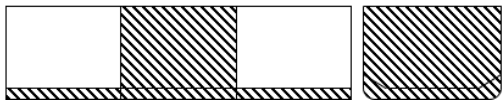
The cargo mass and cargo density under consideration are to be in accordance with [Table 4.2.2-1](#) instead of the requirements of [4.6.2.6, Part 1](#).

4.3.2.3 Hull Girder Loads



In applying [4.6.2.10, Part 1](#), the value M_{SV} is to be the values specified in [Table 4.3.2-1](#) and [Table 4.3.2-2](#).

4.3.3 Harbour Condition

4.3.3.1 Loading Condition

In applying [4.6.3.1, Part 1](#), the loading conditions specified in [Table 4.3.3-1](#) are to be considered.

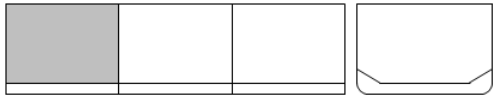
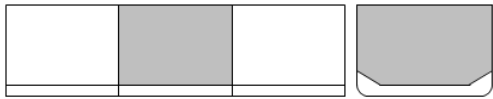
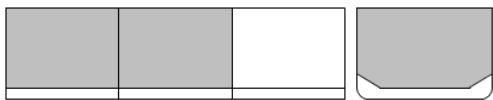
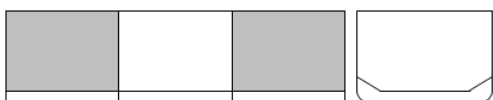
Table 4.3.3-1 Loading Conditions to be Considered in Harbour Condition

Loading condition	Loading pattern		Draught	Vertical bending moment in harbour
Harbour condition	P1		T_{PT-max}	M_{PT-max}
				M_{PT-min}
	P2		T_{PT-min}	M_{PT-max}
				M_{PT-min}
	P3		T_{PT-min}	M_{PT-max}
				M_{PT-min}
	P4		T_{PT-max}	M_{PT-max}
				M_{PT-min}
 : As specified in Table 4.3.2-1 .				
Notes: T_{PT-max} : Maximum designed draught in harbour (m). However, the lower limit is the maximum draught and the upper limit is the scantling draught of the loading conditions in harbour described in the loading manual. T_{PT-min} : Minimum designed draught in harbour (m). The upper limit is the smallest draught of the loading conditions in harbour described in the loading manual.				

4.3.3.2 Hull Girder Loads

In applying [4.6.3.5, Part 1](#), the vertical bending moment in harbour for the loading condition to be considered is to be in accordance with the requirements of [4.3.3.1](#).

4.4 Loads to be Considered in Fatigue

4.4.1 General

4.4.1.1 General

1 The loads to be considered in the fatigue strength assessment specified in [Chapter 9](#) and [Chapter 9, Part 1](#) are also to be in accordance with the requirements of [4.4](#).

2 Additional requirements for loads in the cyclic load condition are to be in accordance with the requirements of [4.4.2](#).

4.4.2 Cyclic Load Condition

4.4.2.1 Loading Conditions

In applying [4.7.2.1, Part 1](#), the loading conditions specified in [Table 4.4.2-1](#) are to be considered. Where strength assessment of other than ballast hold is carried out, loading conditions specified in [Table 4.4.2-2](#) are to be considered additionally instead of heavy ballast condition specified in [Table 4.4.2-1](#). However, where actual condition is different with loading patterns specified in [Table 4.4.2-1](#) and/or [Table 4.4.2-2](#) because of tank arrangement, etc., loading patterns based upon the loading conditions in the loading manual may be considered.

Table 4.4.2-1 Loading Conditions to be Considered in Cyclic Load Condition (Ballast Hold)



Loading condition ⁽¹⁾	Loading pattern		Draught	Vertical still water bending moment	Equivalent design wave
Homogeneous full load condition	FA1		T_{SC}	Values for the loading conditions to be considered	HM FM BR BP
Heavy ballast condition	FA2		T_{BAL-H}		
 As specified in Table 4.3.2-1 .					
Notes: (1) The radius of gyration (m) around the X -axis, is taken as $0.35B$ in the homogeneous full load condition, and is taken as $0.40B$ in heavy ballast condition. However, the value calculated based on the weight distribution according to the loading condition to be considered can be used.					

Table 4.4.2-2 Loading Conditions to be Considered in Cyclic Load Condition (Additional Requirements for other than Ballast Hold)

Loading condition ⁽¹⁾⁽²⁾	Loading pattern		Draught	Vertical still water bending moment	Equivalent design wave
Ballast condition	FA2		T_{BAL-H}	Values for the loading conditions to consider	HM FM BR BP
 As specified in Table 4.3.2-1 .					
Notes: (1) The radius of gyration (m) around the X -axis, is taken as $0.40B$. However, the value calculated based on the weight distribution according to the loading condition to be considered can be used. (2) When assessing a cargo hold adjacent to a ballast hold, the condition in which the ballast hold is filled with ballast water is to be considered.					

4.4.2.2 Internal Pressure due to Wood Chip Cargo

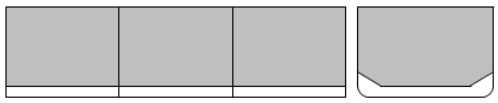
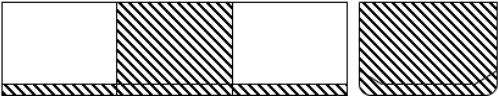
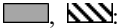
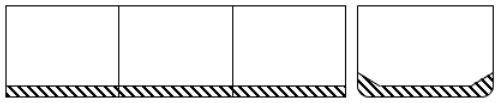
The cargo mass and cargo density to be considered are to be in accordance with [Table 4.2.2-1](#) instead of the requirements of [4.7.2.6, Part 1](#).

Chapter 5 LONGITUDINAL STRENGTH

5.1 Hull Girder Ultimate Strength

5.1.1 Strength Criteria

5.1.1.1 Effect of Double Bottom Bending

In the assessment decision specified in [5.4.2.2, Part 1](#), the coefficient γ_{DB} that takes into account the effect of double bottom bending is as follows.

$$\gamma_{DB} = 1.15$$

Chapter 6 LOCAL STRENGTH

6.1 General

6.1.1 Application

6.1.1.1 Chip Carriers

An example of local strength requirements for chip carriers is shown in [Fig. 6.1.1-2](#). Plates and stiffeners received lateral loads that are not shown in [Fig. 6.1.1-2](#) are to be assessed in accordance with the requirements of [6.3](#) and [6.4, Part 1](#).

Fig. 6.1.1-2 Application Example of Chip Carriers

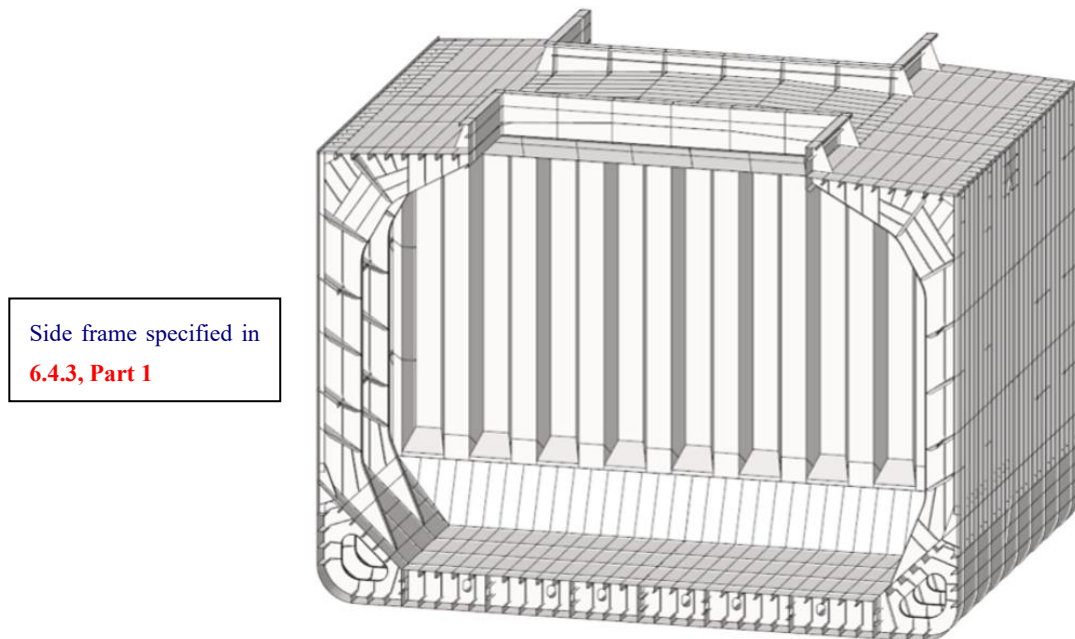

6.2 Ballast Holds

6.2.1 Side Frames

6.2.1.1 Scantlings of Side Frames

The section modulus of the side frame and the thickness of the web in the cargo hold where the ballast is loaded are to satisfy the requirements of [6.4.2](#) and [6.4.3.2, Part 1](#). However, when applying [6.4.2, Part 1](#), only assessment based on a liquid cargo in [Table 6.2.2-1, Part 1](#) is applied, and the effective bending span and effective shear span of the side frame is specified in [6.4.3.2, Part 1](#).

6.3 Bilge Hopper Tanks

6.3.1 Side Longitudinals and Longitudinals on Bilge Hopper Plating

6.3.1.1 Connections of the Bottom of the Side Frame

In applying the requirements of [6.4, Part 1](#), the section modulus of the side longitudinals and longitudinals on bilge hopper plating that support the support brackets installed inside the bilge hopper tank specified in [10.2.2.2-2](#) are not to be less than the value calculated as the distance (m) between the girders in the formula ℓ regardless of the placement of the support bracket.

Chapter 8 STRENGTH ASSESSMENT BY CARGO HOLD ANALYSIS

8.1 General

8.1.1 Overview

8.1.1.1 Structure and Overview of this Chapter

- 1 This Chapter specifies the method of strength assessment by cargo hold analysis for wood chip carriers.
- 2 The structure and overview of this Chapter are shown in [Table 8.1.1-1](#).

Table 8.1.1-1 Overview of Chapter 8

Section	Title	Overview
8.1	General	Additional requirements related to the overview and application of this Chapter
8.2	Evaluation Area and Members to be Assessed	Additional requirements related to the evaluation area and members to be assessed
8.3	Structural Models	Additional requirements related to the modelling range, modelling members, meshing, etc.
8.4	Boundary Conditions and Loads Conditions	Additional requirements related to the boundary conditions and load conditions
8.5	Strength Assessment	Additional requirements for buckling strength assessment

8.1.2 Application

8.1.2.1 Applicable Ships

Ships that strength assessment by cargo hold analysis is required, which fall under [8.1.2.1-1\(2\), Part 1](#) are to be ships of which the length of L_C is 150 m or more.

8.2 Evaluation Area and Members to be Assessed

8.2.1 Members to be Assessed

8.2.2.1 Members to be Assessed for Maximum Load Condition, Harbour Condition and Testing Condition

In applying [8.2.2.1, Part 1](#), the structures and members to be assessed are to be as follows:

- (1) Double bottoms (bottom shell, inner bottom plating, hopper tank sloping, centre girder, side girder and floor)
- (2) Ship side structure (Side shell, side stringer, side frame and web frame)
- (3) Bulkhead structure
- (4) Deck structure (strength deck, cross deck and hatch coaming, etc.)
- (5) Other members and locations deemed necessary by the Society

8.3 Structural Models

8.3.1 General

8.3.1.1 Modelling Range

In applying [8.3.1.1, Part 1](#), the model is, in principle, to represent three adjacent cargo holds with the target hold in the middle and the full depth and the full width of the holds are to be modelled.

8.3.2 Meshing**8.3.2.1 Openings**

In principle, openings in the transverse girder in the bilge part are to be modelled by recreating the opening's shape or removing the appropriate elements in consideration of size and position of the opening.

8.4 Boundary Conditions and Loads Conditions**8.4.1 Boundary Conditions****8.4.1.1**

In applying **8.5.1, Part 1**, the boundary conditions are to be in accordance with **8.4.1, Part 2-2**.

8.4.2 Loads Condition**8.4.2.1 Loads to be Considered**

In applying **8.5.2, Part 1**, loads based also upon the additional requirements specified in **4.3** are to be considered.

8.4.2.2 Method of Applying Moments to the Structural Model

In applying **8.5.2, Part 1**, the vertical bending moment and horizontal bending moment act on the target hold are to be adjusted in accordance with the method specified in **8.4.2, Part 2-2**.

8.5 Strength Assessment**8.5.1 Buckling Strength****8.5.1.1 Strength Assessment of Side Shell in Head Sea and Following Sea**

Where strength assessment is performed considering the load based on the equivalent design waves *HM-1* and *FM-1* in the maximum load condition, buckling strength criteria in the shorter side direction of the panels are taken to be satisfied, instead of **8.6.2.1-1, Part 1**, for plate panels in side shell above neutral axis of cross section when the following is satisfied:

- (1) The requirements of the hull girder ultimate strength as specified in **5.4, Part 1** are satisfied.

8.5.1.2 Strength Assessment of Cross Deck in Head Sea and Following Sea

Where strength assessment is performed considering the loads based on the equivalent design waves *HM-1* and *FM-1* in the maximum load condition, the assessment specified in **8.6.2.1-1, Part 1** may not be carried out for plate panel on cross deck stiffened in transverse direction when the following is satisfied:

- (1) The stress in longitudinal direction on cross deck due to vertical bending moment is act on the narrow area enough compared to the length of cross deck in transverse direction.
- (2) Thickness of cross deck adjacent to upper deck longitudinally stiffened is greater than 50 % of thickness of the upper deck.

Chapter 9 FATIGUE

9.1 General

9.1.1 Rule Application for Fatigue Requirements

9.1.1.1 General

Notwithstanding the requirements specified in **9.2.4, Part 1**, the target hold for fatigue strength assessment is the ballast hold.

9.1.1.2 Application

Ships with a length L_C of 150 m or more are to be assessed for fatigue strength based on the hot spot stresses obtained by simplified stress analysis according to **9.3, Part 1** and finite element analysis according to **9.4, Part 1**.

9.2 Structural Details to be Assessed

9.2.1 Structural Details to be Assessed by Finite Element Analysis

9.2.1.1

1 Critical structural details to be assessed for fatigue strength by finite element analysis according to **9.4, Part 1**, are shown in **Table 9.2.1-1**.

2 Notwithstanding the requirements specified in -1 above, documents demonstrating sufficient fatigue strength are submitted and deemed appropriate to the Society, the fatigue strength assessment of the structure may be omitted.

Table 9.2.1-1 Structural Details of Primary Members to be Assessed in the Hull Structure

No.	Critical structural details of hull structure
1	Intersections between bilge hopper plating and inner bottom plating
2	Intersections between lower stool and inner bottom plating in way of bottom girder
3	Hatch corner
4	Intersections of lower stool and corrugated bulkhead
5	Web frame toe on bilge hopper plating
6	Side frame toe on bilge hopper plating
7	Intersections of web frame and hatch side girder
8	Intersections of side frame and side stringer
9	Intersections of side stringer and transverse bulkhead
10	Other areas with large stress concentration

9.3 Loading Conditions and Fraction of Time to be Considered

9.3.1 General

9.3.1.1

1 Standard loading conditions and fraction of time are to be in accordance with **Table 9.3.1-1**.

2 Notwithstanding the requirements specified in -1 above, when loading conditions and fraction of time other than those shown in **Table 9.3.1-1** are considered, it is necessary to consider the appropriate combinations.

Table 9.3.1-1 Standard Loading Conditions and Fraction of Time

Loading conditions	Fraction of Time $\alpha_{(j)}$
Full load condition (homogeneous loading)	50 %
Heavy ballast condition	50 %

9.4 Boundary Conditions and Load Conditions

9.4.1 Boundary Conditions

9.4.1.1

In applying [9.4.4.1, Part 1](#), the boundary conditions are to be in accordance with [8.4.1.1, Part 2-2](#).

9.4.2 Load Conditions

9.4.2.1 Method of Applying Moments to the Structural Model

In applying [9.4.4.2, Part 1](#), the method of applying moments to the structural model is to be in accordance with [8.4.2.2, Part 2-2](#). However, for the vertical bending moment and horizontal bending moment ($kN-m$) specified in [Table 9.4.2-1](#) are to be used as M_{V-targ} and M_{H-targ} instead of those specified in [Table 8.4.2-1, Part 2-2](#).

 Table 9.4.2-1 M_{V-targ} and M_{H-targ}

	Cyclic load condition
Vertical bending moment M_{V-targ}	M_{V-HG}
Horizontal bending moment M_{H-targ}	M_{H-HG}
Notes: M_{V-HG} , M_{H-HG} : Vertical bending moment and horizontal bending moment ($kN-m$) under cyclic load condition, to be in accordance with 4.7.2.10, Part 1 .	

9.5 Detailed Design Standards

9.5.1 Application

9.5.1.1

When the structural details specified in [9.2](#) are designed according to the detail design standard specified in [9.5](#), the fatigue strength assessment by finite element method for hot spot stress may be omitted.

9.5.2 Lower End of the Side Frame

9.5.2.1 Detail Design Standard A

The welded connections of lower bracket toe of side frame in the ballast hold are to be designed according to detail design standard A, as shown in [Table 9.5.2-1](#).

Table 9.5.2-1 Detail Design Standard A – Lower Toe Detail of Side Frame, Wood Chip Carrier (Ballast Hold)

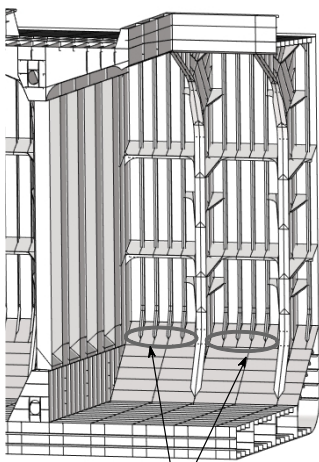
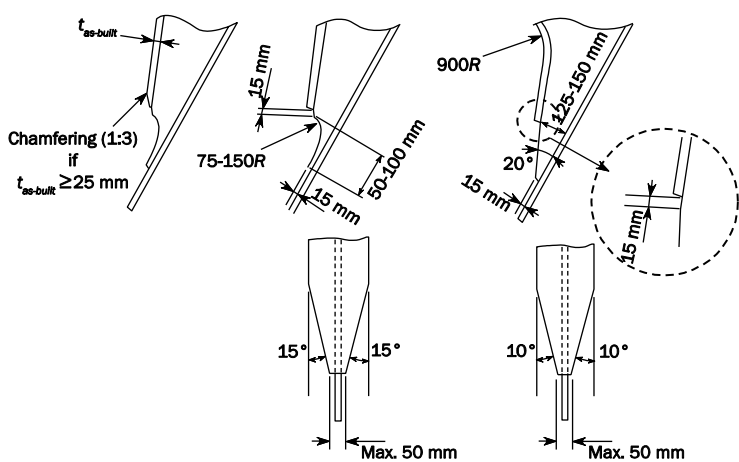
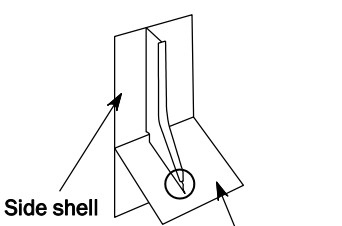
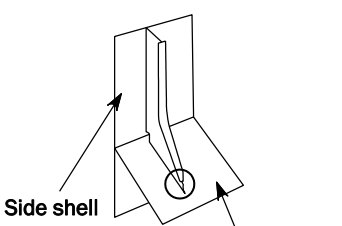
Lower side frame connections	
Critical areas	Detail Design standard A
 <p style="text-align: center;">Critical areas</p>	 <p style="text-align: center;">Example of the soft and extended toes at the end of hold frames.</p>  <p style="text-align: center;">Connection of lower end bracket of hold frame</p>
Critical locations	
 <p style="text-align: center;">Side shell Bilge hopper plating</p> <p>○ : Critical location</p>	
Minimum requirement	As a minimum, detail design standard A is to be applied. Tapered extended toes are more effective and are to be considered for high tensile steel side frame.
Critical part	Toe connection of side frame lower bracket to the bilge hopper plating, including face plate terminations.
Detailed design standards	<p>Alternative geometries than stipulated above are permissible subject to demonstration of satisfactory fatigue performance. However, the maximum angles shown on the figures for thickness chamfering and face width tapering are not to be exceeded. Bracket toe height and the distance between the face plate termination and start of the toe radius (or toe taper) are to be kept to a minimum.</p> <p>The face plates of side frames at lower brackets are to be tapered and chamfered as shown. While chamfering may be dispensed with if the thickness of the face plates is less than 25 mm, it is nevertheless a recommended practice, with a larger gradient if necessary.</p> <p>Side frames are to be built-up symmetrical sections with integral lower brackets and are to be arranged with soft or elongated toes as shown. The side frame flange is to be curved (not knuckled) at the connection with the end brackets.</p> <p>Where the frame lower brackets are not positioned directly above a ring web, supporting brackets are to be provided. In the design ensure that if a hopper tank longitudinal is positioned below the end of the frame lower bracket, the longitudinal cut-out is avoided or closed with a full collar. Increasing the size of supporting brackets will reduce stress concentrations in the critical area.</p>

Construction tolerance	Ensure alignment between side frame lower bracket and transverse ring webs or supporting brackets according to <i>IACS Recommendation No. 47</i> . Maximum misalignment is to be not greater than $t_{as-built}/3$ where $t_{as-built}$ is the thinner as-built thickness of the webs to be aligned and misalignment is the overhang of the as-built thinner thickness.
Welding requirements	Welding is to comply with 12.2.1.2, Part 1 . In way of the wrap around weld at the face plate termination, care is to be taken to ensure no over- run onto the radius part and the toe is free from notches and undercut.

9.5.3 Connections between Side Frame and Side Stringer

9.5.3.1

At the connections between side frame and the side stringer in the ballast hold, the slots provided in the side stringer web are to be eliminated or covered by collar plates.

Chapter 10 ADDITIONAL STRUCTURAL REQUIREMENTS

10.1 Bottom Structure

10.1.1 Double Bottoms

10.1.1.1 Struts

In case where struts are provided, the struts are to be rolled sections other than flat or burb plates and are to sufficiently overlap the webs of the bottom and inner bottom longitudinals.

10.1.1.2 Double Bottom Structure Under the Lower Stool of a Transverse Bulkhead

The inner bottom plating, centre girders, side girders and inner bottom longitudinals under lower stools at transverse bulkheads are to be connected to the extensions of those of holds just before and behind the bulkheads. The floors are to be equivalent to those of holds.

10.1.2 Scuppers

10.1.2.1 General

- 1 One bilge suction pipe is to be provided, in general, on each side of the ship at the after end of each hold.
- 2 Bilge wells are to be provided at suitable positions so as to protect the cover plates from direct impact from bulk cargoes, and to be provided with mud boxes or other suitable means so that the suction openings are not choked by dust.
- 3 Where bilge pipes pass through double bottoms or bilge hopper tanks, non-return valves or stop valves capable of being closed down from a readily accessible position are to be provided at their open ends.

10.2 Side Structure

10.2.1 Bilge Hopper Tanks

10.2.1.1 Continuity of Strength

- 1 Sufficient care is to be taken for the continuity of strength at fore and after ends of bilge hopper tank structure.
- 2 Floor plates are to be provided at the forward and after ends of bilge hopper tanks, and the tank top plating in the engine room is to be extended into the bilge hopper tanks by about two frame spaces.

10.2.1.2 Transverse webs

Where effective struts are provided at an intermediate position on transverse webs, the depth of transverse webs in the bilge hopper tanks is not to be less than 1/6 of the overall length of the transverse webs. Otherwise, the depth is not to be less than 1/5 of the overall length of the transverse webs and 2.5 times the depth of slots for penetrating the longitudinals, whichever is greater.

10.2.2 Side Frames

10.2.2.1 General

- 1 The thickness of webs near the upper and lower end connections of side frames is to be sufficient against shearing.
- 2 In ships having a length L_C of more than 190 m or ships in which high tensile steel is used for the side frame, the cross section of the side frame of the ballast hold is to be symmetrical.
- 3 In ships other than ships specified in -2 above, in cases where side frames having an asymmetrical cross section is installed, those side frames in the foremost cargo hold are to be appropriately supported by side stringers, tripping brackets, etc.
- 4 The web depth to thickness ratio of side frames is not to exceed the following values:
For side frames with symmetrically section : As specified in [3.5.2.2, Part 1](#).
For side frames with asymmetrically section : 40
- 5 For side frames with asymmetrical section or flanged side frames, the outstanding breadth to thickness ratio of face plate or flange is not to exceed 12 times the face plate or flange thickness.

10.2.2.2 Upper and Lower Ends Connections of Side Frames

- 1 Upper and lower ends of side frames are to be connected with deck plating and bilge hopper tanks by brackets.

2 Structural continuity with the upper and lower end connections of side frames is to be ensured within bilge hopper tanks by connecting brackets. The toes of brackets connecting frames with bilge hopper plating are not to coincide with connecting bracket ends in the tanks.

3 The connecting brackets in bilge hopper tanks specified in -2 above are to be stiffened against buckling.

4 The side frames in the ballast hold are to be fabricated with integral upper and lower brackets.

5 The thickness of end brackets attached to side frames is not to be less than the thickness of the webs of those side frames.

10.3 Bulkhead Structure

10.3.1 Transverse Bulkheads

10.3.1.1 General

1 Single strakes of transverse bulkheads adjacent to the side shell plating are to be reinforced appropriately.

2 For transverse bulkheads without lower stools, the thickness of the lowest strake of bulkhead plating is to be appropriately increased according to the thickness of the inner bottom plating.

10.3.2 Lower and Upper Stools at Transverse Bulkheads

10.3.2.1 General

1 In lower stools at transverse bulkheads, stiffening girders are to be provided at the centre girder and side girders of the double bottoms.

2 Where the cargo holds are so designed as to be loaded with ballast water or heavy cargo, the stiffening girders in the lower stools of the transverse bulkheads are to be sufficient against shearing by taking measures such as adopting diaphragms.

3 For ships designed for loading and/or unloading in multiple ports, upper stools deemed as appropriate by the Society are to be provided on vertical corrugated type transverse bulkheads.

10.4 Deck Structure

10.4.1 Hatch End Coaming

10.4.1.1

Hatch end coaming are to be provided in coincidence with the position of the deck transverses. If not coincident, sufficient care is to be taken for the continuity of strength at the connections of hatch end coamings with deck transverses.

10.5 Other

10.5.1 Supplementary Requirements for Ballast Holds

10.5.1.1

In cases where the cargo hold is used as a ballast tank, in general, they are to be kept empty or full throughout the duration of the voyage in order to avoid impact due to the dynamic load of the ballast water.

Part 2-5 GENERAL CARGO SHIPS AND REFRIGERATED CARGO SHIPS

Chapter 1 GENERAL

1.1 General

1.1.1 Application

1.1.1.1 Application of This Part

1 The hull construction and equipment of ships intended to be registered as general cargo ships or refrigerated cargo ships are to be in accordance with the requirements in [Part 2-5](#) in addition to [Part 1](#).

2 The requirements in [Part 2-5](#) are for ships with double bottoms and two or more decks for which the decks and bottoms have a longitudinal framing system.

3 General cargo ships or refrigerated cargo ships with a different construction from that specified in -2 above, to which the requirements in this Part are considered to be not applicable, are to be at the discretion of the Society.

1.1.1.2 Application of Chapter XII of the SOLAS Convention

Ships to which this part applies, those deemed to be bulk carriers as defined in [An1.2.1 \(1\)](#), [Annex 1.1 “Additional Requirements for Bulk Carriers in Chapter XII of the SOLAS Convention”](#), [Part 2-2](#) are to also comply with the annex.

1.2 Definitions

1.2.1 Naming Convention

1.2.1.1 Structural Nomenclature

[Fig. 1.2.1-1](#) and [Fig. 1.2.1-2](#) show the common structural nomenclature used in [Part 2-5](#).

Fig. 1.2.1-1 General Cargo Ships

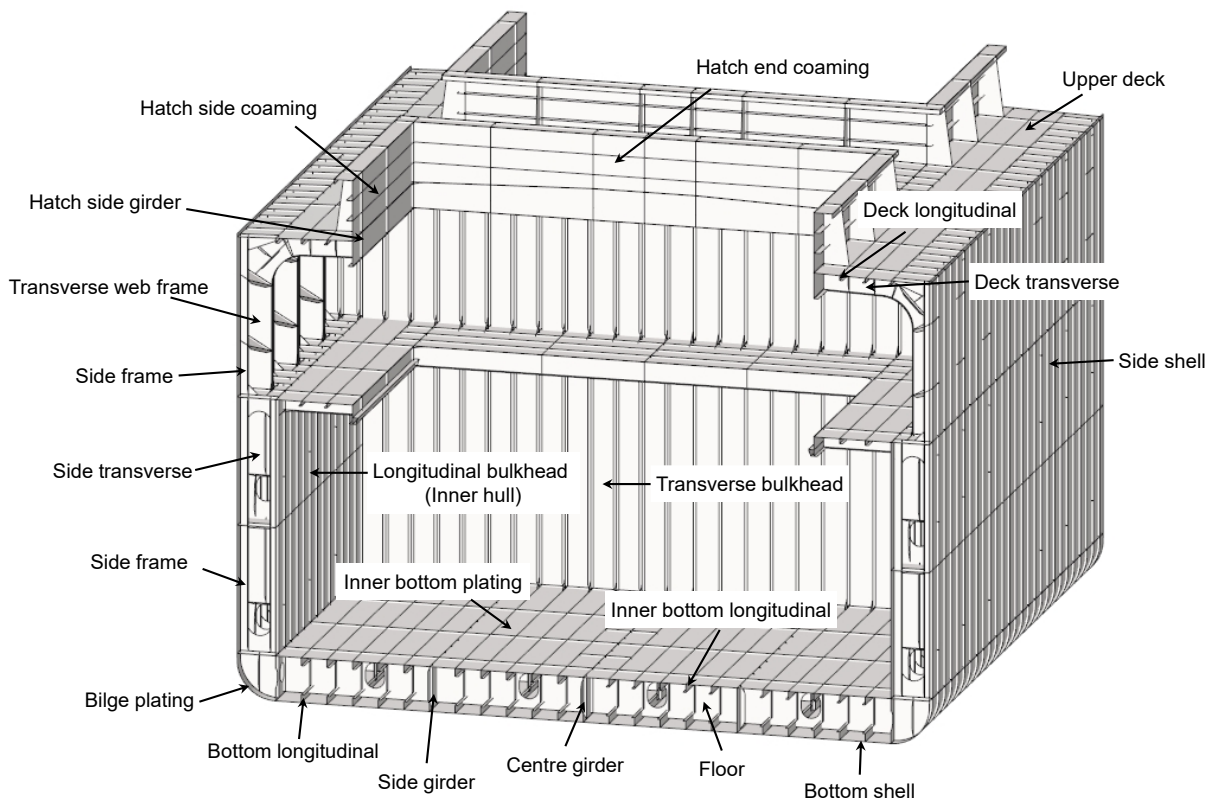
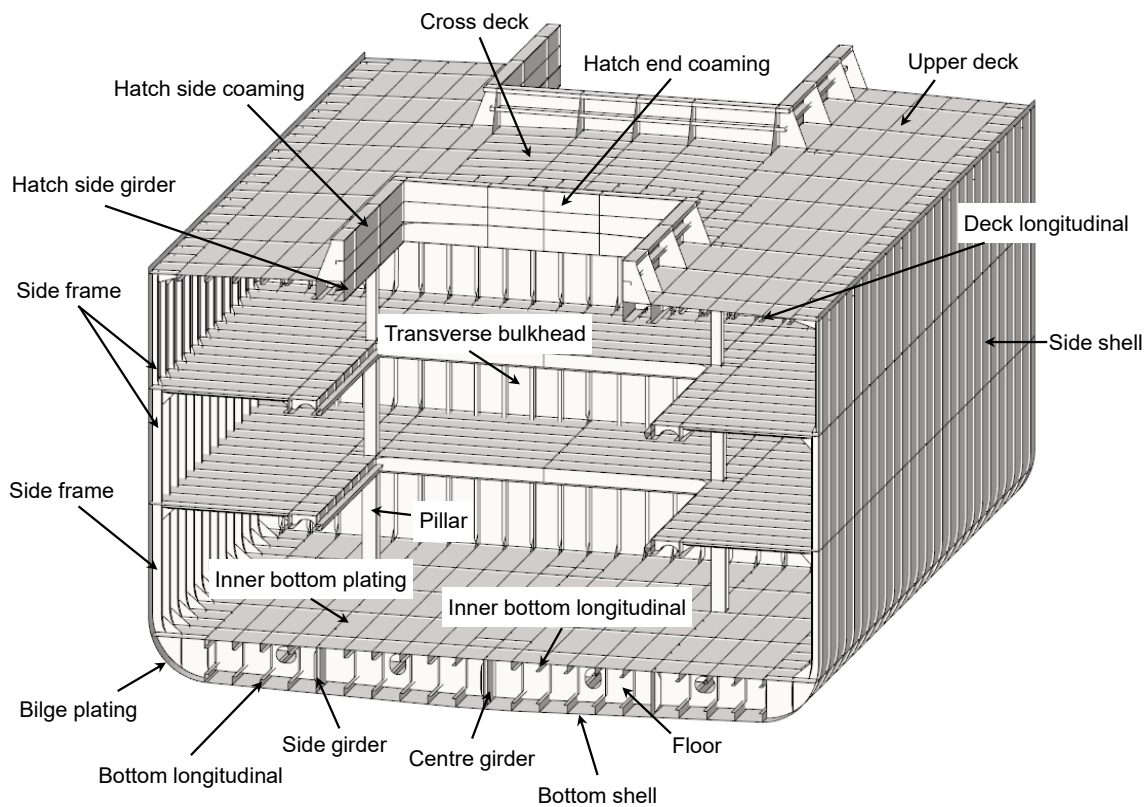

Fig. 1.2.1-2 Reefer Ships



Chapter 3 STRUCTURAL DESIGN PRINCIPLES

3.1 (Deleted)

3.2 Loading Manuals and Loading Instruments

3.2.1 Additional Requirements for Loading Manuals and Loading Instruments

3.2.1.1 General

For ships to which [Annex 1.1, Part 2-2 “Additional Requirements for Bulk Carriers in Chapter XII of the SOLAS Convention”](#) applies according to [1.1.1.2](#), the requirements of [3.2, Part 2-2](#) are to also be followed.

Chapter 4 LOADS

4.1 General

4.1.1 Overview

4.1.1.1 Structure and Overview of this Chapter

This Chapter specifies the additional requirements shown in [Table 4.1.1-1](#) as the loads used for each formula and strength assessments to determine the scantlings specified in [Part 2-5](#) and [Part 1](#).

Table 4.1.1-1 Overview of Chapter 4

Section	Title	Summary
4.1	General	Requirements for the general principle of Chapter 4
4.2	Loads to be Considered in Local Strength	Additional requirements for loads to be considered in the requirements of local strength specified in Chapter 6 and Chapter 6, Part 1 .
4.3	Loads to be Considered in Strength of Primary Supporting Structures	Additional requirements for loads to be considered in the requirements of strength of primary supporting structures specified in Chapter 7 and Chapter 7, Part 1 .
4.4	Loads to be Considered in Additional Structural Requirements	Additional requirements for loads to be considered in the requirements of additional structural requirements specified in Chapter 10 and Chapter 10, Part 1 .

4.2 Loads to be Considered in Local Strength

4.2.1 General

4.2.1.1 General

1 The loads to be considered in the requirements of local strength specified in [Chapter 6](#) and [Chapter 6, Part 1](#) are to also be in accordance with [4.2](#).

2 Additional requirements for loads in the maximum load condition are to be in accordance with [4.2.2](#).

4.2.2 Maximum Load Condition

4.2.2.1 Lateral Loads

1 Cargo mass and cargo density are to comply with [Table 4.2.2-1](#) instead of [4.4.2.5 Part 1](#); however, for ships in which the loading condition of high-density bulk cargo is included as a standard loading condition in the loading manual, [4.4.2.5 Part 1](#) is to be applied, and cargo mass and cargo density are to be appropriately considered.

2 In applying [4.4.2, Part 1](#), the parameters (GM , z_G , etc.) required to calculate dynamic pressure due to cargo are to be the values for the appropriate loading condition among all full load conditions in consideration of cargo mass and cargo density. However, the values in [Table 4.2.2-2](#) may be used if the parameters are not available.

3 In applying [4.4.2, Part 1](#), the parameters (GM , z_G , etc.) required to calculate dynamic pressure due to ballast water are to be the values for the ballast condition. The same parameters are to be applied where the dynamic pressure due to liquid other than ballast water, such as the pressure due to fuel oil tank, is considered. However, the values in [Table 4.2.2-2](#) may be used if the parameters are

not available.

Table 4.2.2-1 Dry Bulk Cargo Mass and Cargo Density

Consideration of dry bulk cargo mass M (t)	M_D
Cargo density ρ_C (t/m ³)	$\frac{M_D}{V_{Full}}$
Notes M_D : Maximum permissible cargo mass (t) in the cargo hold under consideration V_{Full} : Volume (m ³) of the hold (including its hatch coaming).	

Table 4.2.2-2 Simplified Formulae of Parameter

Loading condition	Draught T_{LC} (m) amidships	Z coordinate z_G (m) of the centre of gravity of the ship	Metacentric height GM (m)	Radius of Gyration K_{xx} (m)
Full load condition	T_{SC}	$0.25 \frac{B}{C_B}$	$\frac{T_{SC}}{2} + \frac{B^2}{T_{SC} C_B} \frac{3C_W - 1}{24} - z_G$	$0.35B$
Ballast condition	T_{BAL}	$0.20 \frac{B}{C_{B,LC}}$	$\frac{T_{LC}}{2} + \frac{B^2}{T_{LC} C_{B,LC}} \frac{3C_{W,LC} - 1}{24} - z_G$	$0.40B$

4.3 Loads to be Considered in Strength of Primary Supporting Structures

4.3.1 General

4.3.1.1 General

1 The loads to be considered in the requirements of strength of primary supporting structures specified in [Chapter 7](#) and [Chapter 7, Part 1](#) are also to be in accordance with [4.3](#); however, [4.4, Chapter 4, Part 2-2](#) is to be applied where the cargo density ρ_C is more than 0.9 for double hull structure ships, or to holds with double hull structure ships that are empty in the fully loaded condition. The definition of ρ_C is as specified in [Table 4.2.2-1](#).

2 Additional requirements for loads in the maximum load condition are to be in accordance with [4.3.2](#).

3 The loads in the harbour condition may not be considered.

4.3.2 Maximum Load Condition

4.3.2.1 General

1 Loads for simple girders are also to be in accordance with the relevant requirements of [4.2](#).

2 The loads specified in [Table 4.3.2-1](#) are to be considered when applying the requirements for double hull. However, where deemed necessary by the Society, additional loading patterns taken the loading conditions into account specified in the loading manual may be required.

Table 4.3.2-1 Loads to be Considered in Maximum Load Condition

Structures to be assessed		Loading patterns			Equivalent design wave	Difference between external and internal pressure to be considered (kN/m^2)
		Draught(m)	Vertical still water bending moment ($kN-m$)	Loaded to be considered		
Double bottom	S1	$0.6T_{SC}$	$M_{SV\ max}$	None	HM-1 / HM-2	Double bottom: P_{DB} Double side: P_{DS}
Double side	S2	T_{SC}	$M_{SV\ min}$	Cargo	BP-1P / BP-1S	
	S3	T_{SC}	$M_{SV\ min}$	Cargo		

4.3.2.2 External Pressure

For the requirements of double hull, the hydrostatic pressure and the hydrodynamic pressure at the equivalent design wave specified in [Table 4.3.2-2](#) are to be considered.

Table 4.3.2-2 External and Internal Pressure to be Considered

Structures to be assessed		$P_{DB}(kN/m^2)^{(1)(2)}$	$P_{DS}(kN/m^2)^{(1)(2)}$
Double bottom	S1 ⁽³⁾	$P_{exs} + P_{exw}$	$P_{exs} + P_{exw}$
Double side	S2	$P_{exs} + P_{exw} - P_{in_s2}$	$P_{exs} + P_{exw}$
	S3	$P_{exs} + P_{exw} - P_{in_s3}$	$P_{exs} + P_{exw}$
Notes: P_{exs} , P_{exw} : Hydrostatic and Hydrodynamic pressure (kN/m^2) act on bottom shell in case of P_{DB} . Those values act on side shell in case of P_{DS} . Each value is calculated in accordance with 4.6.2.4, Part 1 . P_{in_s2} , P_{in_s3} : Loads considering the effect of cargo (kN/m^2), as given by the formulae: $P_{in_s2} = 0.5\rho g T_{SC}$ $P_{in_s3} = \rho g T_{SC}$			
(1) Load calculation points are to be in accordance with 7.3.1.5, Part 1 for all loading conditions. (2) When calculating loads, $T_{LC} = 0.6T_{SC}$ for S1 and $T_{LC} = T_{SC}$ for S2 and S3. (3) P_{exw} is to be not less than the value of P_{exw} for HM-2 at x_G , which is the X coordinate (m) at the centre of gravity of the ship.			

4.3.2.3 Internal Pressure

For the requirements of double hull, internal pressure specified in [Table 4.3.2-2](#) is to be considered.

4.3.2.4 Vertical Bending Moment

1 The vertical still water bending moments and the vertical wave bending moments for the equivalent design waves specified in [4.3.2.1-2](#) are to be considered in the requirements for double hull.

2 The vertical wave bending moment considered for each equivalent design wave is to be in accordance with [4.6.2.10, Part 1](#).

4.4 Loads to be Considered in Additional Structural Requirements

4.4.1 General

4.4.1.1 General

1 The loads to be considered in the additional structural requirements specified in [Chapter 10](#) and [Chapter 10, Part 1](#) are to also

be in accordance with 4.4.

2 Additional requirements for loads in the maximum load condition are to be in accordance with 4.4.2.

4.4.2 Maximum Load Condition

4.4.2.1 Steel Coils

1 The requirements are given by assuming the following (1) to (7).

- (1) It is assumed that steel coil cores are arranged in the longitudinal direction and loaded securing as shown in Fig. 4.4.2-1.
- (2) When one and a half-tiered loading is included in the design conditions, only one steel coil is assumed for the second tier adjacent to the bottom steel coil. Examples of steel coil arrangements are given in Table 4.4.2-1.
- (3) When two-tiered loading is included in the design conditions, it is assumed that only the bottom steel coil is in contact with the longitudinal bulkhead or side frame. It is assumed as the design condition that either only the bottom tier or also the second tier is in contact with the bilge hopper plating.
- (4) When three-tiered loading is included in the design conditions, it is assumed that at least two of the tiers are in contact with the bilge hopper plating, the longitudinal bulkhead or the side frame.
- (5) There are two types of steel coil arrangements for inner bottoms: one is when the floor position is considered, and the other is when the floor position is not considered.
- (6) All steel coils have the same characteristics.
- (7) In the case where does not fall under (1) to (6) above, the loads are to be determined by an appropriate method.

2 The total load F_{SC} (kN) of the steel coil acting on the hull is to be calculated by the following formula. However, it is not to be less than 0.

$$F_{SC} = F_{SCs} + F_{SCd}$$

F_{SCs} : Static load (kN), as specified in Table 4.4.2-2.

F_{SCd} : Dynamic load (kN), as specified in Table 4.4.2-3.

3 In applying -2 above, the number of load points per panel by dunnage n_2 and the distance between the load points of dunnage at both ends of each panel ℓ_{lp} are to be in accordance with the following (1) to (2).

- (1) Steel coil arrangements that do not consider floor position are to be as specified in Fig. 4.4.2-2 and Table 4.4.2-5.
- (2) Steel coil arrangements that do consider floor position are to be as specified in the following (a) to (b). (See Fig. 4.4.2-3)
 - (a) The number of load points per panel by dunnage n_2 is to be $n_2 = n_3$.
 - (b) The distance between the load points of the dunnage at both ends of each panel ℓ_{lp} is to be the distance between the dunnage at both ends supporting a row of steel coils.

4 In determining the vertical bending moment M_{V-HG} (kN-m) and horizontal bending moment M_{H-HG} (kN-m) acting on the hull, the load conditions shown in Table 4.4.2-7 are to be considered. For load conditions HF and RP, the requirements of 4.4.2, Part 1 are to be followed.

Fig. 4.4.2-1 Example of Securing Means for Steel Coils

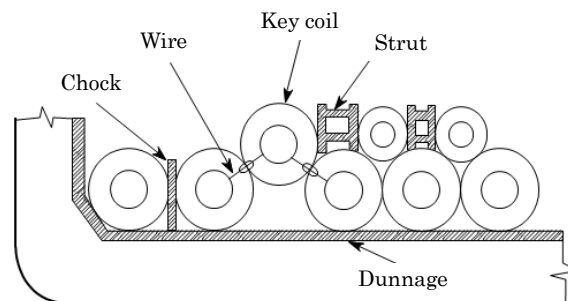

Table 4.4.2-1 Example of Loading Conditions for Each Loading Tier



Number of Tiers		Example	
Single-tiered loading	$n_1 = 1$	<ul style="list-style-type: none"> Without Key Coil 	<ul style="list-style-type: none"> With Key Coil 
			
Multi-tiered loading	$n_1 = 1.5$		
	$n_1 = 2$		
			
$n_1 = 3$			

Table 4.4.2-2 Static Load of Steel Coil F_{SCs}

Members	n_2 and n_3	F_{SCs} (kN)
Inner bottom plating	$n_2 \leq 10$ and $n_3 \leq 5$	$C_{SC1} W_{SC} \frac{n_1 n_2}{n_3} g$
	$n_2 > 10$ or $n_3 > 5$	$C_{SC1} W_{SC} n_1 \frac{\ell}{\ell_{st}} g$
Bilge hopper plating	$n_2 \leq 10$ and $n_3 \leq 5$	$C_{SC2} W_{SC} \frac{n_2}{n_3} g \cdot \cos \alpha$
	$n_2 > 10$ or $n_3 > 5$	$C_{SC2} W_{SC} \frac{\ell}{\ell_{st}} g \cdot \cos \alpha$
Longitudinal bulkheads and side frames	NA	0

Notes:

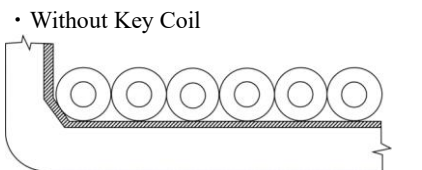
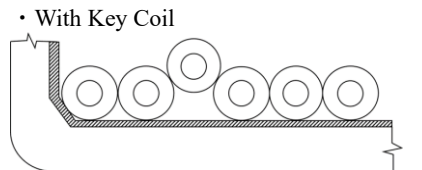
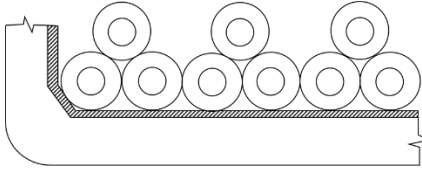
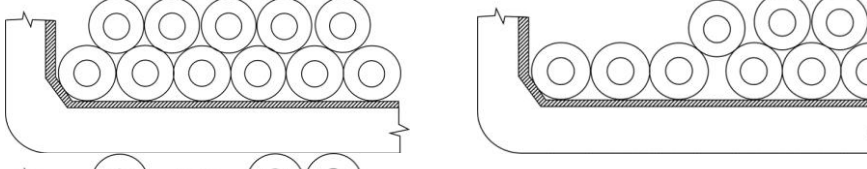
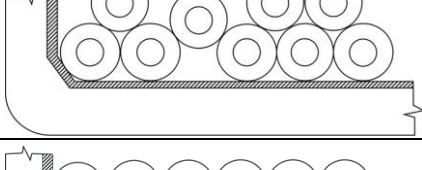
n_1 : Number of loading stages of steel coil

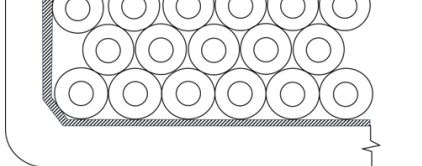
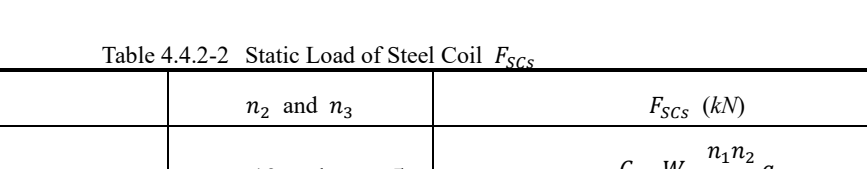
n_2 : The load point per panel (the number of dunnages for a single panel), as specified in **4.4.2.1-3**.

n_3 : Number of dunnage threads supporting one row of steel coils

W_{SC} : Mass of one steel coil (t)

C_{SC1} : Coefficient as follows:
 $C_{SC1} = 1.4$ for single-tiered loading secured with one or more key coils
 $C_{SC1} = 1.0$ for multi-tiered loading or single-tiered loading without key coils

C_{SC2} : Coefficient, as follows:
 $C_{SC2} = 1.0$ for single-tiered loading
 $C_{SC2} = 1.1$ for one and a half-tiered loading or two-tiered loading, or for single-tiered loading and also the case where a key coil is placed in the second position from the bilge hopper plating
 $C_{SC2} = 1.2$ for three-tiered loading

ℓ : Distance between floors (m) (See **Fig. 4.4.2-2**)

ℓ_{st} : Steel coil length (m) (See **Fig. 4.4.2-2**)

α : The angle between the inner bottom plating and the bilge hopper plating (rad)

 Table 4.4.2-3 Dynamic Load F_{SCd}

Members	Load in waves F_{SCd} (kN)	
Inner bottoms	$\frac{F_{SCs}}{g} C_{WDz} a_{ze-sc}$	
Bilge hopper plating	Case 1	$\frac{F_{SCs}}{g} C_{WDz} a_{ze-sc} \cdot \cos \alpha$
	Case 2	$C_{SC3} W_{SC} \frac{n_1 n_2}{n_3} g \sin \theta \cdot \cos \left(\min \left(\frac{\pi}{2} - \alpha, \frac{\pi}{4} \right) \right)$
Longitudinal bulkheads	$n_2 \leq 10$ and $n_3 \leq 5$	$C_{SC3} W_{SC} \frac{n_1 n_2}{n_3} g \sin \theta$
	$n_2 > 10$ or $n_3 > 5$	$C_{SC3} W_{SC} n_1 \frac{\ell}{\ell_{st}} g \sin \theta$
Side frames	$C_{SC3} W_{SC} \frac{n_1}{n_4} g \sin \theta$	

Notes:

C_{WDz} : Coefficient of each load condition, specified in **Table 4.4.2-8, Part 1**

a_{ze-sc} : Envelope acceleration in vertical direction (m/s^2) at the centre of gravity of steel coil in the cargo hold to be considered, as calculated in accordance with **4.2.4.1, Part 1**⁽¹⁾

α , n_1 , n_2 , n_3 , W_{SC} , ℓ , ℓ_{st} : As specified in **Table 4.4.2-2**

θ : Roll angle (rad), as specified in **4.2.2, Part 1**⁽²⁾.

C_{SC3} : Coefficient, as follows:
 $C_{SC3} = 3.2$ for single-tiered stacking or multi-tiered stacking in which the key coil is arranged in the second or third position from the ship side
 $C_{SC3} = 2.0$ for all other cases

n_4 : The number of side frames that support a single steel coil.

(1) The centre of gravity of steel coil to be considered is in accordance with **Table 4.4.2-4**.

(2) The parameters (GM , z_G , etc.) required to calculate the ship motions and acceleration is in accordance with the values in the full load condition. The values in **Table 4.2.2-2** may be used if the parameters is not available.

Table 4.4.2-4 The Centre of Gravity of Steel Coil

	The location of the centre of gravity(m)
The location in longitudinal direction, x_{sc}	Volumetric centre of gravity of cargo hold under consideration
The location in transverse direction, y_{sc}	$\varepsilon \frac{B_H}{4}$
Notes:	
ε : Coefficient to be taken as: For assessing the members on port side, $\varepsilon = 1.0$ For assessing the members on starboard side, $\varepsilon = -1.0$	
B_H : Breadth of cargo hold (m), measured at the mid-length of the cargo hold and at the mid height between lower end of hatch side coaming and inner bottom plating at the centre line, Table 4.4.2-9, Part 1 .	

Fig. 4.4.2-2 Loading of Steel Coils on the Inner Bottom without Taking into Consideration the Floor Position

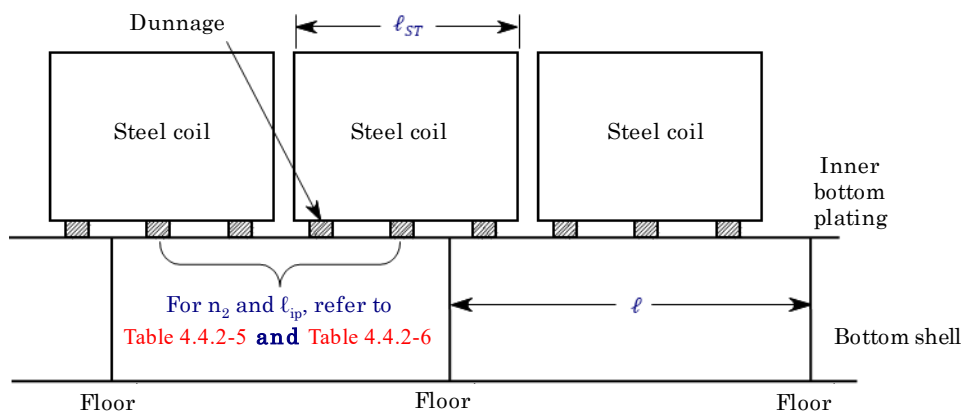

Fig. 4.4.2-3 Loading of Steel Coils on the Inner Bottom Taking into Consideration the Floor Position

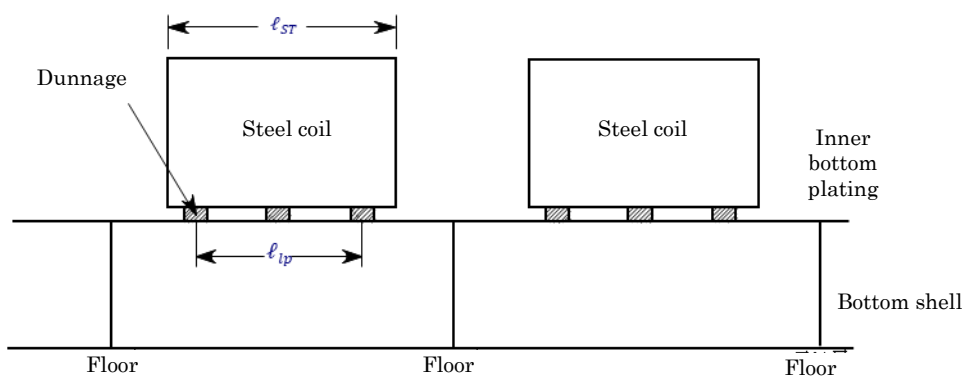

Table 4.4.2-5 Number of Load Points Per Panel According to Dunnage n_2

n_2	n_3			
	2	3	4	5
1	$0 < \ell/\ell_{st} \leq 0.5$	$0 < \ell/\ell_{st} \leq 0.33$	$0 < \ell/\ell_{st} \leq 0.25$	$0 < \ell/\ell_{st} \leq 0.2$
2	$0.5 < \ell/\ell_{st} \leq 1.2$	$0.33 < \ell/\ell_{st} \leq 0.67$	$0.25 < \ell/\ell_{st} \leq 0.5$	$0.2 < \ell/\ell_{st} \leq 0.4$
3	$1.2 < \ell/\ell_{st} \leq 1.7$	$0.67 < \ell/\ell_{st} \leq 1.2$	$0.5 < \ell/\ell_{st} \leq 0.75$	$0.4 < \ell/\ell_{st} \leq 0.6$
4	$1.7 < \ell/\ell_{st} \leq 2.4$	$1.2 < \ell/\ell_{st} \leq 1.53$	$0.75 < \ell/\ell_{st} \leq 1.2$	$0.6 < \ell/\ell_{st} \leq 0.8$
5	$2.4 < \ell/\ell_{st} \leq 2.9$	$1.53 < \ell/\ell_{st} \leq 1.87$	$1.2 < \ell/\ell_{st} \leq 1.45$	$0.8 < \ell/\ell_{st} \leq 1.2$
6	$2.9 < \ell/\ell_{st} \leq 3.6$	$1.87 < \ell/\ell_{st} \leq 2.4$	$1.45 < \ell/\ell_{st} \leq 1.7$	$1.2 < \ell/\ell_{st} \leq 1.4$
7	$3.6 < \ell/\ell_{st} \leq 4.1$	$2.4 < \ell/\ell_{st} \leq 2.73$	$1.7 < \ell/\ell_{st} \leq 1.95$	$1.4 < \ell/\ell_{st} \leq 1.6$
8	$4.1 < \ell/\ell_{st} \leq 4.8$	$2.73 < \ell/\ell_{st} \leq 3.07$	$1.95 < \ell/\ell_{st} \leq 2.4$	$1.6 < \ell/\ell_{st} \leq 1.8$
9	$4.8 < \ell/\ell_{st} \leq 5.3$	$3.07 < \ell/\ell_{st} \leq 3.6$	$2.4 < \ell/\ell_{st} \leq 2.65$	$1.8 < \ell/\ell_{st} \leq 2.0$
10	$5.3 < \ell/\ell_{st} \leq 6.0$	$3.6 < \ell/\ell_{st} \leq 3.93$	$2.65 < \ell/\ell_{st} \leq 2.9$	$2.0 < \ell/\ell_{st} \leq 2.4$

 Table 4.4.2-6 Distance Between Load Points of Dunnage on Both Ends of Each Panel ℓ_{lp} (m)

n_2	n_3			
	2	3	4	5
1	Actual width of dunnage			
2	$0.5\ell_{st}$	$0.33\ell_{st}$	$0.25\ell_{st}$	$0.2\ell_{st}$
3	$1.2\ell_{st}$	$0.67\ell_{st}$	$0.50\ell_{st}$	$0.4\ell_{st}$
4	$1.7\ell_{st}$	$1.20\ell_{st}$	$0.75\ell_{st}$	$0.6\ell_{st}$
5	$2.4\ell_{st}$	$1.53\ell_{st}$	$1.20\ell_{st}$	$0.8\ell_{st}$
6	$2.9\ell_{st}$	$1.87\ell_{st}$	$1.45\ell_{st}$	$1.2\ell_{st}$
7	$3.6\ell_{st}$	$2.40\ell_{st}$	$1.70\ell_{st}$	$1.4\ell_{st}$
8	$4.1\ell_{st}$	$2.73\ell_{st}$	$1.95\ell_{st}$	$1.6\ell_{st}$
9	$4.8\ell_{st}$	$3.07\ell_{st}$	$2.40\ell_{st}$	$1.8\ell_{st}$
10	$5.3\ell_{st}$	$3.60\ell_{st}$	$2.65\ell_{st}$	$2.0\ell_{st}$

Table 4.4.2-7 Load Condition of Hull Girder Load

Members	Load condition	
Inner bottom plating	<i>HF</i> and <i>RP</i>	
Bilge hopper plating	Case 1	<i>HF</i>
	Case 2	<i>RP</i>
Longitudinal bulkheads	<i>RP</i>	
Side frames	<i>N/A</i>	

Chapter 6 LOCAL STRENGTH

6.1 General

6.1.1 Application

6.1.1.1 General Cargo Ships

An example of local strength requirements for general cargo ships is shown in Fig. 6.1.1-1. Plates and stiffeners received lateral loads not shown in Fig. 6.1.1-2 are to be assessed in accordance with 6.3 and 6.4, Part 1.

Fig. 6.1.1-1 Application Example of General Cargo Ships

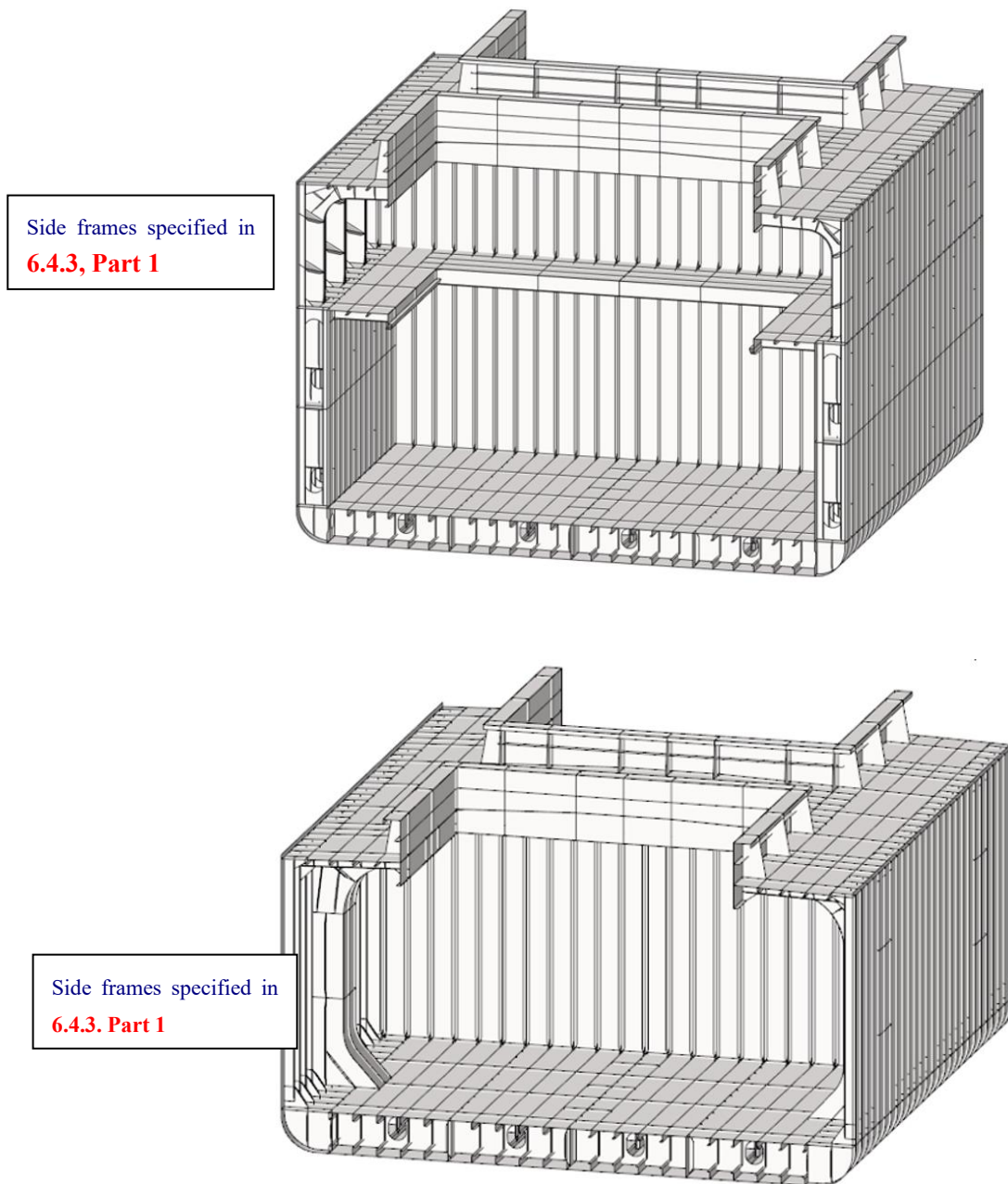

6.1.1.2 Reefer Ships

An example of local strength requirements for reefer ships is shown in [Fig. 6.1.1-2](#). Plates and stiffeners received lateral loads not shown in [Fig. 6.1.1-2](#) are to be assessed in accordance with [6.3](#) and [6.4, Part 1](#).

Fig. 6.1.1-2 Application Example of Reefer Ships

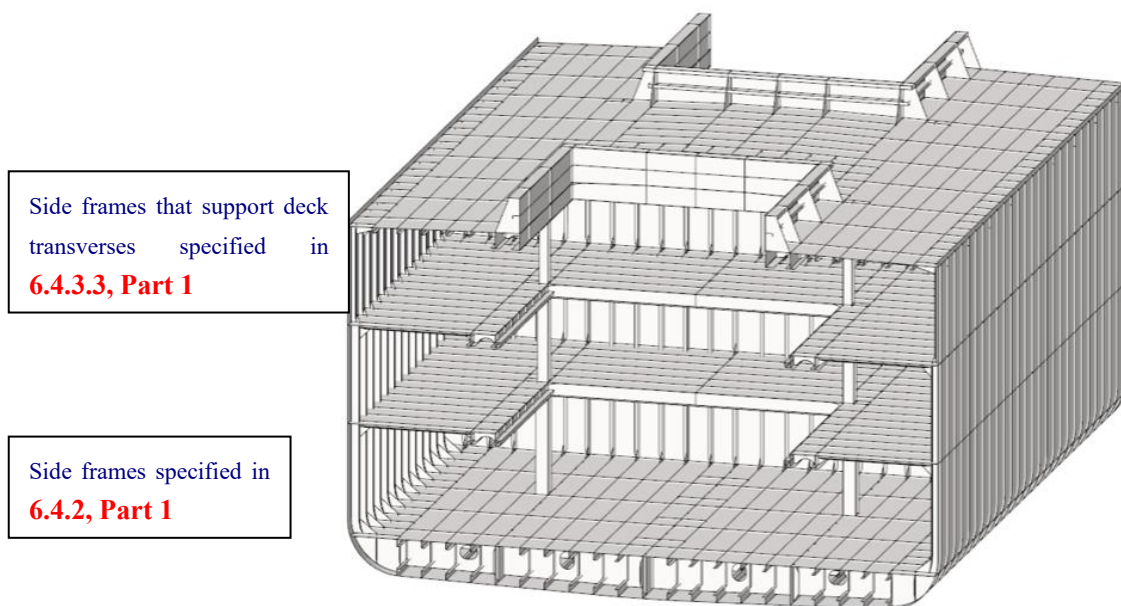

6.2 Ships Loaded with Special Cargo

6.2.1 General

6.2.1.1

Where loads of cargoes are not to be regarded as distributed loads, [6.2](#) is to be followed.

6.2.2 Ships Loaded with Steel Coils

6.2.2.1 Plates and Stiffeners

Plates and stiffeners for ships loaded with steel coils are to be in accordance with [10.1](#).

6.2.3 Ships Loaded with Vehicles (Including Cases Where Vehicles Are Used During Cargo Handling)

6.2.3.1 Plates and Stiffeners

1 The plates and stiffeners of decks and inner bottom platings on which vehicles are loaded are to be in accordance with [10.1, Part 2-6](#).

2 Where plates and stiffeners are subjected to concentrated loads from wheels during cargo handling that vehicles such as forklifts are used, the plates and stiffeners are to be in accordance with [10.1, Part 2-6](#).

6.2.4 Ships Loaded with Other Special Cargo

6.2.4.1

Ships loaded with special cargo other than that described in [6.2.2](#) and [6.2.3](#) above are to be as deemed appropriate by the Society, taking into consideration the mode of action of the load by each cargo.

Chapter 7 STRENGTH OF PRIMARY SUPPORTING STRUCTURES

7.1 General

7.1.1 Application

7.1.1.1

For the double bottom and double-side skin structure, the requirements of the double hull structure specified in **7.3, Part 1** are to be applied. For other girder members that can be regarded as simple girders, the requirement of the simple girder specified in **7.2, Part 1** are to be applied.

7.1.1.2 Application Example of Assessment Model for General Cargo Ship

- 1 An application example of assessment model applying **7.2** and **7.3, Part 1** is shown in **Fig. 7.1.1-1**.
- 2 For girder members deemed to be simple girders with structures different from that shown in **Fig. 7.1.1-1**, the boundary conditions and acting loads are to be considered, and the assessment model from **Table 7.2.1-2, Part 1** is to be appropriately selected.

Fig. 7.1.1-1 Application Example of General Cargo Ships

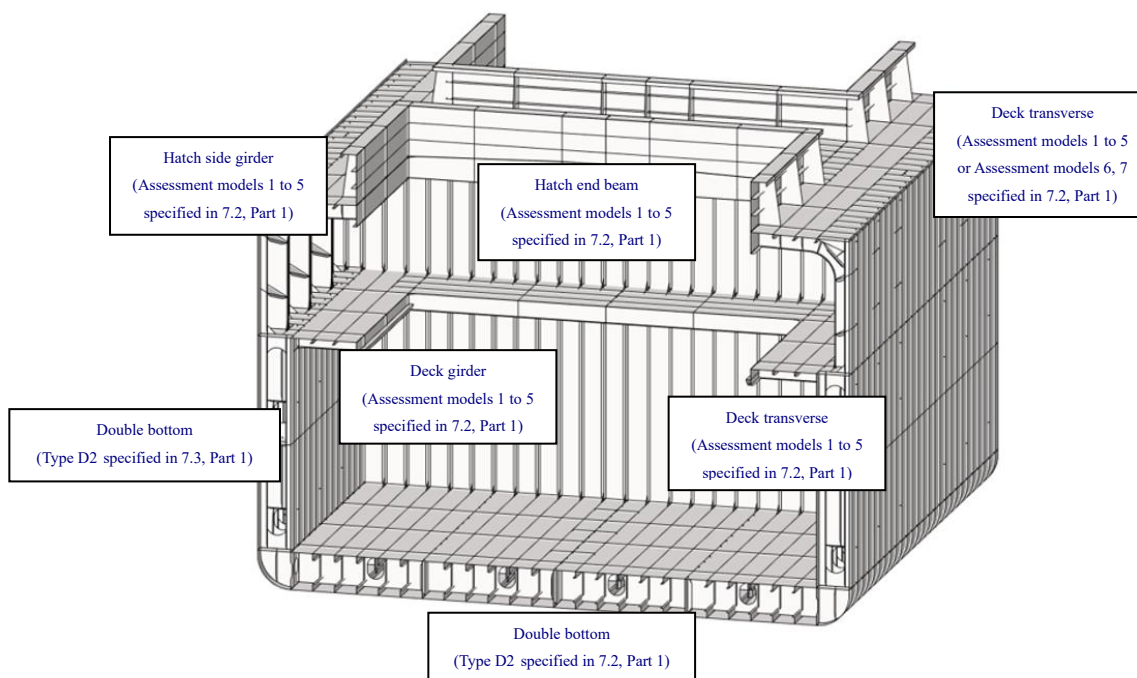

7.1.1.3 Application Example of Assessment Model for Reefer Ship

An application example of an assessment model for a reefer ship is shown in **Fig. 7.1.1-2**. In addition, the structures not shown in **Fig. 7.1.1-2** are as deemed appropriate by the Society.

Fig. 7.1.1-2 Application Example of Reefer Ships

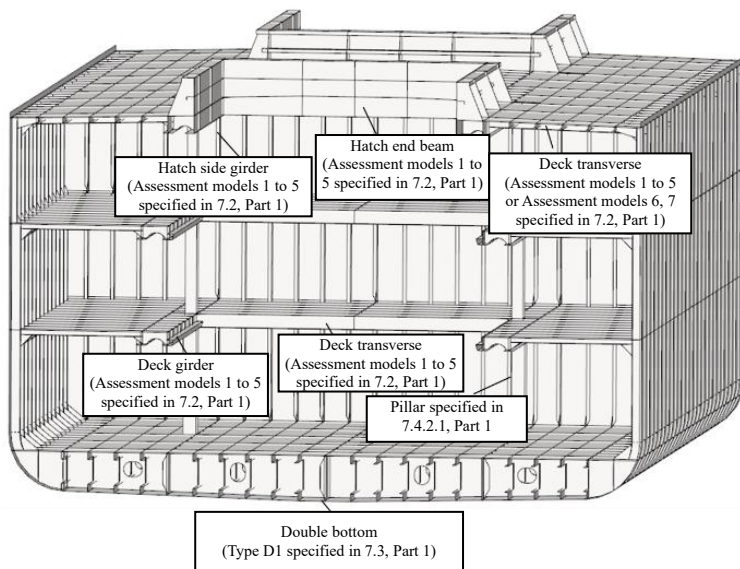

7.2 Simple Girders

7.2.1 Hatch Side Girders

7.2.1.1 Hatch Side Girders Supported by Pillars, etc.

Where hatch side girders are supported by support members such as pillars, the following requirements (1) and (2) are to be complied.

- (1) The required cross-sectional property is to be the value calculated by the method specified in 7.2.3.1, Part 1 multiplied by the value of C_{BC} shown in Fig. 7.2.1-1 according to the positional relationship between the pillar and the hatch side coaming.
- (2) If (a) to (c) in Fig. 7.2.1-1 are applicable, hatch side coamings may be considered in cross-sectional property calculations.

Fig. 7.2.1-1 Hatch Side Girders Supported by Pillars, etc.

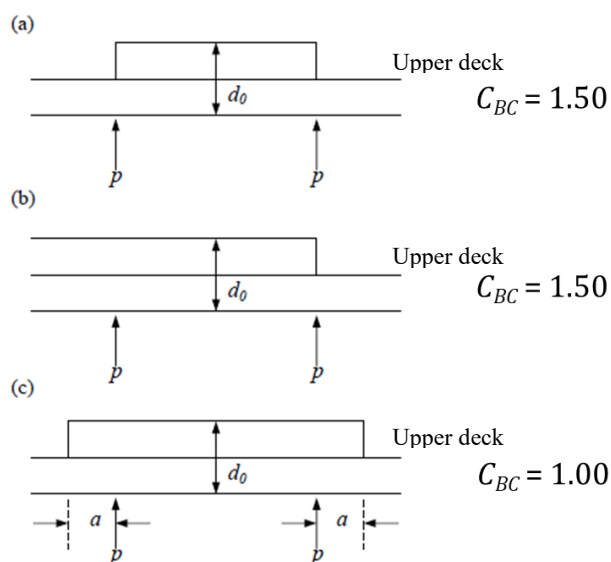

7.2.2 Web Frames

7.2.2.1 Web Frames Supporting Cantilever Beams

In applying **7.2.2.2, Part 1** to double-deck ships with the first layers being double side and the second layers being single side, moments and shear forces are to be in accordance with **7.2.2.2(1), Part 1**. However, ℓ_2 and m_2 shown in **Fig. 7.2.2-1** are to be used.

Fig. 7.2.2-1 Web Frames of Double-deck Ships with the First Layers being Double Side and the Second Layers being Single Side

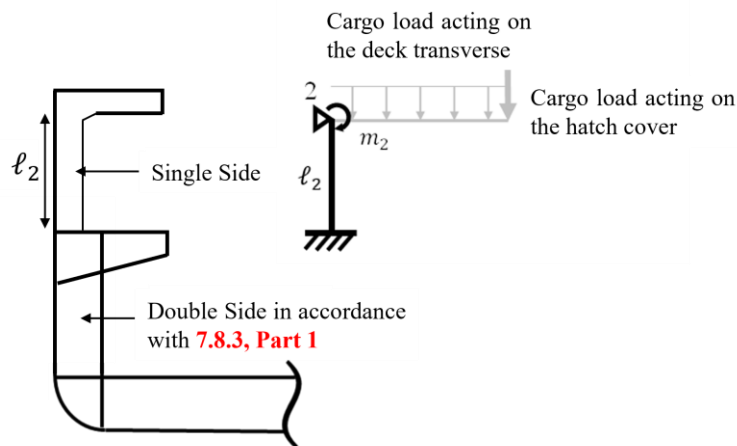

7.3 Double Hull Structures

7.3.1 General

7.3.1.1 Idealisation of Structures of Double-deck Ships with the First Layers being Double Side and the Second Layers being Single Side

- 1 Hatchway breadth is to be taken as the breadth of the hatchway of the first tier. (See **Fig. 7.3.1-1**)
- 2 B_{DS} is to be taken as the distance up to the upper end of the double side. (See **Fig. 7.3.1-1**)

Fig. 7.3.1-1 Hatchway Breadth and Double Side Height

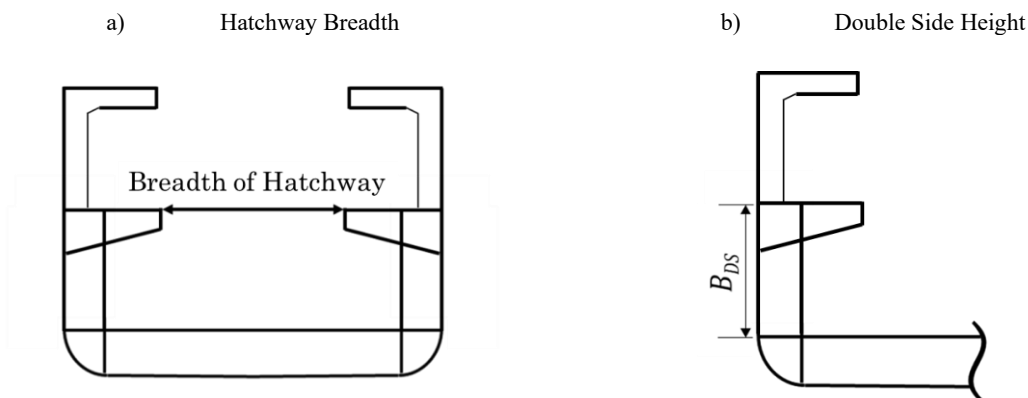

7.4 Special Cargo

7.4.1 Ships Loaded with Steel Coils

7.4.1.1

Girder members subjected to the loads of steel coil are to be in accordance with **10.1.6**.

Chapter 10 ADDITIONAL STRUCTURAL REQUIREMENTS

10.1 Ships Carrying Steel Coils

10.1.1 General

10.1.1.1 Application

- 1 **10.1** applies to ships that are loaded with steel coils in their cargo holds.
- 2 The plate members and stiffeners shown in **Table 10.1.1-1** are to satisfy **10.1**.

Table 10.1.1-1 Applicable Plate Members and Stiffeners

Ship type (see Fig. 10.1.1-1)	Applicable plate members and stiffeners
With hopper slant plate	Inner bottoms, longitudinal frames with inner bottoms, hopper slant plates, longitudinal frames with hopper slant plates
Without hopper slant plate	Double-side skin structure Inner bottoms, longitudinal frames with inner bottoms, longitudinal bulkheads, longitudinal frames with longitudinal bulkheads
	Single-side skin structure Inner bottoms, longitudinal frames with inner bottoms, side frames

Fig. 10.1.1-1 Examples of Ships Without Hopper Slant Plates ((a), (b)) and With Hopper Slant Plates ((c))

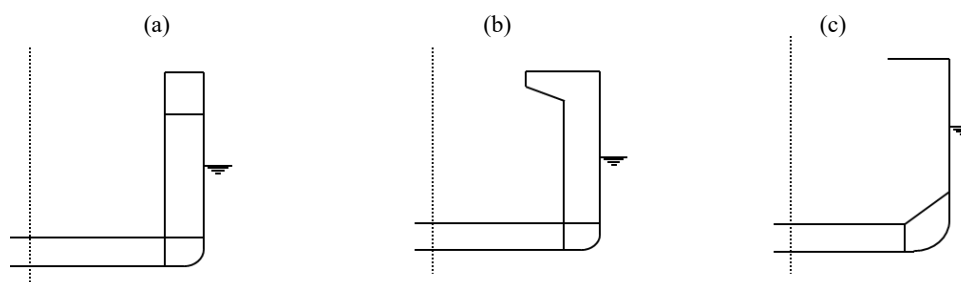

10.1.1.2 Assumptions

It is assumed in **10.1** that inner bottoms, hopper slant plates and longitudinal bulkheads are a vertically structured. It is also assumed that the sides of single-side ships without hopper slant plates are horizontally structured. For other cases, examinations are to be performed according to individual conditions.

10.1.2 Inner Bottom Platings and Longitudinals

10.1.2.1 Inner Bottom Platings

The thickness of the inner bottom plating is not to be less than that obtained from the following formulae.

$$t = K_1 \sqrt{\frac{F_{SC}}{C_a \sigma_Y}} \times 10^3 (\text{mm})$$

Where:

σ_Y : Specified minimum yield stress (N/mm^2)

F_{SC} : Load (kN) acting on the inner bottom according to **4.4.2.1-2**.

K_1 : Coefficient.

$$K_1 = \sqrt{\frac{1.7 \frac{s}{1000} \ell K_2 - 0.73 \left(\frac{s}{1000}\right)^2 K_2^2 - (\ell - \ell_{lp})^2}{2 \ell_{lp} \left(2 \frac{s}{1000} + 2 \ell K_2\right)}}$$

K_2 : Coefficient

$$K_2 = -\frac{s}{1000 \ell} + \sqrt{\left(\frac{s}{1000 \ell}\right)^2 + 1.37 \left(\frac{1000 \ell}{s}\right)^2 \left(1 - \frac{\ell_{lp}}{\ell}\right)^2 + 2.33}$$

C_a : Axial force effect coefficient according to **6.3.2.1, Part 1**.

s : Distance between stiffeners (mm)

ℓ : Distance between floors (m)

ℓ_{lp} : The distance between the load points of the dunnage at both ends of each panel (m) according to **4.4.2.1-3**

10.1.2.2 Inner Bottoms Longitudinals

The section moduli and the web thickness of inner bottom longitudinal are not to be less than that obtained from the following formulae.

$$Z = K_3 \frac{F_{SC} \ell_{bdg}}{8C_s \sigma_Y} \times 10^3 (cm^3), t_w = \frac{0.5F_{SC}}{d_{shr} \tau_Y} \times 10^3 (mm)$$

Where:

σ_Y : Specified minimum yield stress (N/mm^2)

τ_Y : Allowable shear stress (N/mm^2)

$$\sigma_Y / \sqrt{3}$$

F_{SC} : Load (kN) acting on a longitudinal frame with inner bottom according to **4.4.2.1-2**, ℓ is to be substituted by ℓ_{bdg} .

K_3 : Coefficient according to **Table 10.1.2-1** $K_3 = 2/3$ for $n_2 > 10$

n_2 : The load point per panel (the number of dunnages on one panel) according to **4.4.2.1-3**

C_s : Coefficient related to the influence of axial force according to **Table 6.4.2.1, Part 1**

ℓ_{bdg} : Effective bending span (m) of stiffener according to **3.6.1.2, Part 1**

d_{shr} : Effective shear depth (mm) of stiffener according to **3.6.4.2, Part 1**

ℓ_{lp} : The distance (m) between the load points of the dunnage at both ends for each panel according to **4.4.2.1-3**

Table 10.1.2-1 Coefficient K_3

n_2	1	2	3	4	5
K_3	1.0	$1.0 - \left(\frac{\ell_{lp}}{\ell_{bdg}}\right)^2$	$1.0 - \frac{2}{3} \left(\frac{\ell_{lp}}{\ell_{bdg}}\right)^2$	$1.0 - \frac{5}{9} \left(\frac{\ell_{lp}}{\ell_{bdg}}\right)^2$	$1.0 - \frac{1}{2} \left(\frac{\ell_{lp}}{\ell_{bdg}}\right)^2$
n_2	6	7	8	9	10
K_3	$1.0 - \frac{7}{15} \left(\frac{\ell_{lp}}{\ell_{bdg}}\right)^2$	$1.0 - \frac{4}{9} \left(\frac{\ell_{lp}}{\ell_{bdg}}\right)^2$	$1.0 - \frac{3}{7} \left(\frac{\ell_{lp}}{\ell_{bdg}}\right)^2$	$1.0 - \frac{5}{12} \left(\frac{\ell_{lp}}{\ell_{bdg}}\right)^2$	$1.0 - \frac{11}{27} \left(\frac{\ell_{lp}}{\ell_{bdg}}\right)^2$

10.1.2.3 Inner Bottoms Longitudinals with Struts

1 The buckling strength of struts is to be in accordance with **7.4.2, Part 1**. However, the load F (kN) is to be according as follows.

$$F = \frac{\lambda R + P_{ex} s b \times 10^{-6}}{\lambda + 1}$$

Where:

λ : Ratio of the moment of inertia of the inner bottom longitudinal and the bottom longitudinal

$$\lambda = \frac{I_B}{I_I}$$

Where:

I_B : Moment of inertia (cm^4) of the bottom longitudinal including the actual attached plate

I_I : Moment of inertia (cm^4) of the inner bottom longitudinal including the actual attached plate

P_{ex} : The lateral load (kN/m^2) due to the external pressure acting on the bottom shell under the maximum load condition specified in **4.4.2, Part 1** is calculated for the bottom shell where the struts are installed

R : Reaction force (kN) acting on the simple support point of the continuous beam with the strut position as the simple support (see **Fig. 10.1.2-1**)

s : Spacing between stiffeners (mm)

b : Breadth of part supported by struts (mm)

2 The section modulus is not to be less than that obtained from the following formula. However, it is necessary to consider the conditions that correspond to either the following (1) or (2). It is presumed that the load condition is a steel coil loaded directly above the longitudinal and that a concentrated load works at the position of the dunnage.

$$Z = \frac{M}{C_S \sigma_Y} \times 10^3 (cm^3)$$

- (1) Equidistant load points (see Fig. 10.1.2-2)

$$M_B = \frac{W}{2\ell_{fs}^2} \left[\sum_{k=1}^n \{a_1 + (k-1)\ell_1\} \ell_{fs}^2 - \sum_{k=1}^n \{a_1 + (k-1)\ell_1\}^3 \right]$$

$$M_{Cm} = \frac{W\{a_1 + (m-1)\ell_1\}}{2\ell_{fs}^3} \left[\sum_{k=1}^n \{a_1 + (k-1)\ell_1\}^3 - 3\ell_{fs}^2 \sum_{k=1}^n \left\{ a_1 + (k-1)\ell_1 - \frac{2}{3}\ell_{fs} \right\} \right] - \sum_{k=1}^m W(m-k)\ell_1$$

- (2) Non-equidistant load points (see Fig. 10.1.2-3)

$$M_B = \sum_{k=1}^n \frac{W a_k (\ell_{fs}^2 - a_k^2)}{2\ell_{fs}^2}$$

$$M_{Cm} = \sum_{k=1}^n \frac{W (\ell_{fs} - a_k)^2 (2\ell_{fs} + a_k)}{2\ell_{fs}^3} a_m - \sum_{k=1}^m W (a_m - a_k)$$

Where:

M : Bending moment ($kN-m$) and is to be the larger of M_B and M_C

n : Maximum total number of load points between girders and struts

M_B : Bending moment at fixed end ($kN-m$)

M_{Cm} : Bending moment at the m -th load point from the strut support point ($kN-m$)

M_C : The bending moment ($kN-m$) at the load point is to be the largest of the following values M_{C1} , M_{C2} , M_{C3} , and M_{Cn}

a_m : Distance from strut support point to the m -th load point (m)

a_1 : The distance (m) from the strut support point to the first load point, and the value when the dunnage is arranged so that the values from M_{C1} to M_{Cm} and M_B are maximum values

ℓ_1 : Distance between load points (m)

ℓ_{fs} : Distance between girders and struts (m)

W : The load of the steel coil that each dunnage is responsible for (kN):

$$W = \frac{F_{SC}}{n_2}$$

F_{SC} : Total load by steel coil acting on the plate panel (kN) (see 4.4.2.1-2), ℓ is to be substituted by ℓ_{bdg} .

n_2 : The load point per panel (the number of dunnages for a single panel), as specified in 4.4.2.1-3.

3 The web thickness is not to be less than that obtained from the following formulae. However, it is necessary to consider under the conditions that correspond to either the following (1) or (2). It is presumed that the load condition is a steel coil loaded directly above the longitudinal and that a concentrated load is acting at the dunnage position.

$$t_w = \frac{F}{d_{shr} \tau_Y} \times 10^3 (mm)$$

- (1) Equidistant load points (see Fig. 10.1.2-2)

$$R_A = \frac{W}{2\ell_{fs}^3} \left[\sum_{k=1}^n \{a_1 + (k-1)\ell_1\}^3 - 3\ell_{fs}^2 \sum_{k=1}^n \left\{ a_1 + (k-1)\ell_1 - \frac{2}{3}\ell_{fs} \right\} \right]$$

$$R_B = \frac{W}{2\ell_{fs}^3} \left[3\ell_{fs}^2 \sum_{k=1}^n \{a_1 + (k-1)\ell_1\} - \sum_{k=1}^n \{a_1 + (k-1)\ell_1\}^3 \right]$$

- (2) Load point position user determined (see Fig. 10.1.2-3)

$$R_A = \sum_{k=1}^n \frac{W (\ell_{fs} - a_k)^2 (2\ell_{fs} + a_k)}{2\ell_{fs}^3}$$

$$R_B = \sum_{k=1}^n \frac{W a_k (3\ell_{fs}^2 + a_k^2)}{2\ell_{fs}^3}$$

Where:

F : Shear force (kN) and is to be the larger of R_A and R_B

R_A : Reaction force with simple support (kN)

R_B : Reaction force at fixed end (kN)

a_1 : Distance (m) from the strut support point to the first load point, and the value when the dunnage is arranged so that the respective values of R_A and R_B are maximum values

Fig. 10.1.2-1 Inner Bottom Longitudinal with Struts

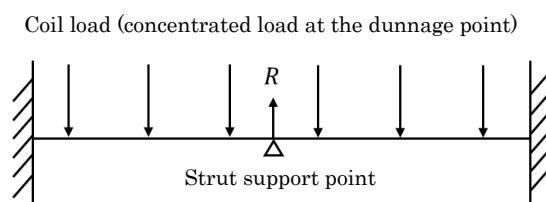

Fig. 10.1.2-2 Load Conditions Between Girders and Struts (Equidistant Load Points)

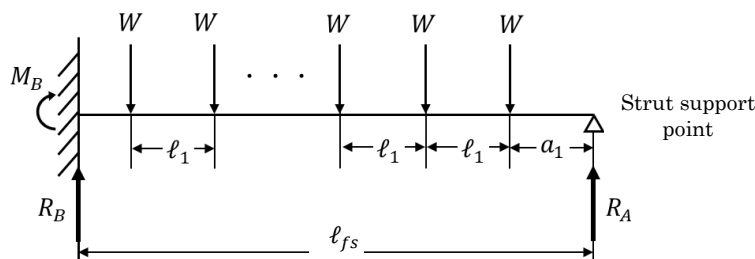
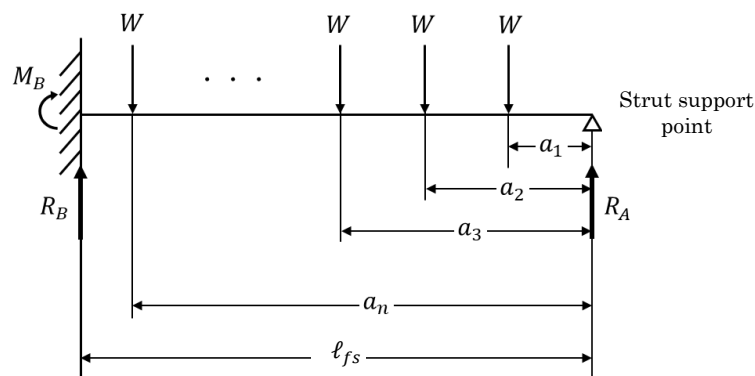

Fig. 10.1.2-3 Load Conditions Between Girders and Struts (Non-Equidistant Load Points)



10.1.3 Bilge Hopper Platings and Longitudinal Frames with Bilge Hopper Platings (Ships with Bilge Hoppers)

10.1.3.1 Bilge Hopper Platings

Bilge hopper plating thickness is to be greater than or equal to the following value. However, this requirement need not to be applied to strakes not in contact with steel coils.

$$t = K_1 \sqrt{\frac{F_{SC}}{C_a \sigma_Y}} \times 10^3 (\text{mm})$$

Where:

F_{SC} : The load (kN) acting on the hopper slant plate according to 4.4.2.1-2

K_1 : Coefficient according to 10.1.2.1

C_a : Axial force influence coefficient according to 6.3.2.1, Part 1

10.1.3.2 Longitudinal Frames with Bilge Hopper Platings

The section moduli and web plate thicknesses of longitudinal frames with bilge hopper platings are to be greater than or equal to the following values. However, this requirement need not to be applied to longitudinals fitted with plate panels not in contact with steel coils.

$$Z = K_3 \frac{F_{SC} \ell_{bdg}}{8 C_s \sigma_Y} \times 10^3 (\text{cm}^3), t_w = \frac{0.5 F_{SC}}{d_{shr} \tau_Y} \times 10^3 (\text{mm})$$

Where:

σ_Y : Specified minimum yield stress (N/mm²)

τ_Y : Allowable shear stress (N/mm²)

$\sigma_Y / \sqrt{3}$

F_{SC} : The load (kN) acting on the longitudinal frame with bilge hopper plating according to 4.4.2.1-2, ℓ is to be substituted by ℓ_{bdg} .

K_3 : Coefficient according to 10.1.2.2

C_s : Coefficient related to the influence of axial force according to 6.4.2.1, Part 1

d_{shr} : Effective shear depth (mm) of stiffener according to 3.6.4.2, Part 1

10.1.4 Longitudinal Bulkheads and Longitudinal Frames with Longitudinal Bulkheads (Ships without Bilge Hopper and Ships with Double Side Shells)

10.1.4.1 Longitudinal Bulkheads

Longitudinal bulkhead thickness is to be greater than or equal to the following value. However, this requirement need not to be applied to strakes not in contact with steel coils.

$$t = K_1 \sqrt{\frac{F_{SC}}{C_a \sigma_Y}} \times 10^3 (\text{mm})$$

Where:

F_{SC} : Load (kN) acting on the longitudinal bulkhead according to 4.4.2.1-2

K_1 : Coefficient according to 10.1.2.1.

C_a : Axial force influence coefficient according to 6.3.2.1, Part 1.

10.1.4.2 Longitudinal Frames with Longitudinal Bulkheads

The section moduli and plate thicknesses of the web plates of longitudinal frames with longitudinal bulkheads are to be greater than or equal to the following values. However, this requirement need not to be applied to the longitudinals fitted with plate panels not in contact with steel coils.

$$Z = K_3 \frac{F_{SC} \ell_{bdg}}{8 C_s \sigma_Y} \times 10^3 (\text{cm}^3), \quad t_w = \frac{0.5 F_{SC}}{d_{shr} \tau_Y} \times 10^3 (\text{mm})$$

Where:

σ_Y : Specified minimum yield stress (N/mm²)

τ_Y : Allowable shear stress (N/mm²)

$$\sigma_Y / \sqrt{3}$$

F_{SC} : Load (kN) acting on the longitudinal frame with longitudinal bulkhead according to 4.4.2.1-2, ℓ is to be substituted by ℓ_{bdg} .

K_3 : Coefficient according to 10.1.2.2

C_s : Coefficient related to the influence of axial force according to 6.4.2.1, Part 1

d_{shr} : Effective shear depth (mm) of stiffener, according to 3.6.4.2, Part 1

10.1.5 Side Frames (Ships Without Bilge Hoppers and Single-Side Ships)

10.1.5.1 Side Frames

1 In the cases other than three-tiered loading, the section moduli and web thicknesses of side frames are to be greater than or equal to the following values.

$$Z = 1.2 \frac{F_{SC} \ell_{1bdg}}{8 \sigma_Y} \times 10^3 (\text{cm}^3),$$

$$t_w = 2.0 \frac{0.5 F_{SC}}{d_{shr} \tau_Y} \times 10^3 (\text{mm})$$

σ_Y : Specified minimum yield stress (N/mm²)

τ_Y : Allowable shear stress (N/mm²)

$$\sigma_Y / \sqrt{3}$$

F_{SC} : Load (kN) acting on the side frame according to 4.4.2.1-2

ℓ_{1bdg} : Effective bending span (m) of the side frame. Where a bracket is provided, the end of the effective bending span is to be taken to the position where the depth of the side frame and the bracket is equal to $2h_w$ (See Fig. 6.4.3-2, Part 1).

d_{shr} : Effective shear depth (mm) of stiffener according to 3.6.4.2, Part 1

2 In the case of three-tiered loading, the section moduli and web thicknesses of side frames are to be treated as simple beams and determined by elastic calculations based on the following conditions:

- (1) Support conditions are fixed at both ends (positions at deck and inner bottom plate)
- (2) Permissible stress is to be σ_Y and τ_Y as specified in -1 above
- (3) As load conditions, F_{SC} for $n_1 = 3$ as specified in 4.4.2.1-2 for the load acting at the bottom steel coils, and F_{SC} for $n_1 = 1$

and no key coil for the load acting at the third tier are to be considered.

10.1.6 Girder Members such as Girders and Floors

10.1.6.1

Girder members (double bottom girders, floors, etc.) that are loaded by steel coils are to have sufficient strength against compression buckling.

10.2 Ships Loaded with Containers

10.2.1 Container Loading Reinforcement

10.2.1.1

Decks below container corner fittings are to be constructed to effectively support the loads of containers, such as by providing girder plates.

10.3 Bulkhead Structures

10.3.1 General

10.3.1.1 Application

10.3 applies to the bulkhead stiffeners of transverse bulkheads.

10.3.2 Dimensions of Bulkhead Stiffeners Directly Under Deck Girders

10.3.2.1

1 The dimensions of bulkhead stiffeners that support deck girders are to satisfy the following formula.

$$C \frac{Z_0}{Z} + \frac{W}{A} \leq C$$

Where:

Z_0 : Specified section modulus (cm^3) of stiffener under maximum load conditions specified in 6.4, Part 1

Z : Actual section modulus (cm^3)

$$C = \frac{\sigma_Y}{C_{safety}}$$

C_{safety} : Bulkhead stiffener safety factor taken as 1.0

A : Stiffener cross-sectional area (cm^2) (plate may be included)

W : Axial loads applied to stiffeners

$$Sbh \text{ (kN)}$$

Where:

S : Spacing between lower vertical girders on decks supported by bulkhead stiffeners (m) (see Fig. 10.3.2-1)

b : Spacing between the centres of each section from that girder to the left and right girders or the inner surface of the frame (m). (See Fig. 10.3.2-2)

h : Deck load (kN/m^2) for that deck determined according to 4.4.2.2, Part 1

However, in the case of two or more decks, it is not necessary to consider W for the upper deck.

Fig. 10.3.2-1 S Measuring Method

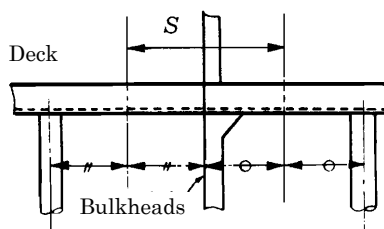
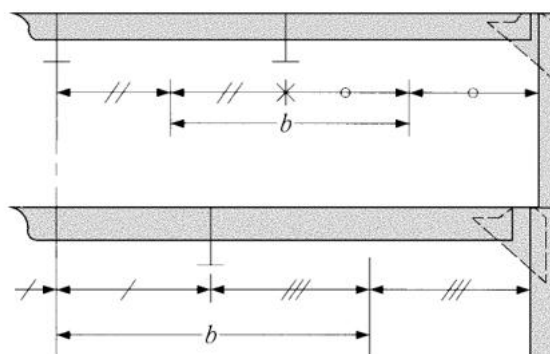

Fig. 10.3.2-2 *b* Measuring Method

2 Dimensions of bulkhead stiffeners directly under cargo handling devices and supporting vertical girders under decks

For the dimensions of bulkhead stiffeners directly under cargo handling devices such as derricks or cranes and that also support vertical girders under decks, the axial loads (W) applied to stiffeners is to be as follows, and **1** above is to be applied. If such stiffeners do not support lower vertical girders on decks, the first term in the following formula is to be taken as zero and the formula in the **-1** above is to be applied.

$$Sbh + F \text{ (kN)}$$

Where:

S , b and h : According to **-1** above.

F : Own weight (kN) of cargo handling device. However, in the case of derricks, the values in [Table 10.3.2-1](#) may be used depending on the derrick model and boom arrangement.

Table 10.3.2-1 Own Weight of Derricks

Boom placement / Derrick type	Independent	Gantry
Boom at either end of ship	2.0ω	2.3ω
Boom at both ends of ship	2.7ω	3.0ω

Note:

ω is the limit load (kN) of each derrick boom. However, averages values are to be used when there are booms at both ends of the ship.

10.4 Ships Loaded with Lumber

10.4.1 Ships Loaded with Lumber

10.4.1.1 Protection of Hull Structure Against Lumber Cargo

The hull structures of ships loaded with lumber in their cargo holds and/or on their decks are to be protected in accordance with the following **(1)** to **(10)**, notwithstanding being marked with the load lines corresponding to timber freeboard assigned in accordance with the requirements of **Part V**. However, where it is obvious from the specifications or other similar documents that the ship is not intended to carry log cargoes, the following requirements except **(8)** and **(10)** may be modified.

(1) Welding

Welding of members that may be impacted by raw timber is to be continuous welding (at least to the fillet size $F2$ specified in [Chapter 12, Part 1](#)).

(2) Deck girders

Tripping brackets are to be provided on hatch side girders and hatch end beams at intervals of approximately 1.5 m to prevent free edges from flexing.

(3) Hatchways

Hatch coamings are to be especially stiffened.

(4) Bulwarks

- (a) Bulwarks are to be supported with particularly solid stays at intervals not exceeding 1.5 *m*.
- (b) It is recommended that the freeing port area provided on bulwarks be as small as possible in way of hatchways and that the area be increased at other locations so as to maintain the total required freeing port area.
- (5) Side frame protection
- Side frame protection is to be in accordance with the following (a) to (d), but this protection may be appropriately considered for ships with a length *L_C* of more than 130 *m*.
- (a) Side frames are to be protected by one of the following methods.
- Install side longitudinal frames or tripping brackets at intervals of approximately 2 *m*.
 - Attach shaped steel to the face material of side frames in the longitudinal direction at intervals of about 1.5 *m*.
 - Attach flat bars of about 150 × 10 (*mm*) to the face material of side frames at intervals of about 0.5 *m* in the longitudinal direction.
- (b) Shaped steel or flat bars (at least two in the case of flat bars) are to be attached to the upper surfaces of the free edges of side frame lower brackets in the longitudinal direction. However, appropriate consideration may be given in cases where lower bracket thickness and face material width are greater than or equal to the following values.
- Bracket thickness *t* (*mm*) is determined by applying 3.5.2.6, Part 1 with the arm length being taken as the long arm length of the bracket in Fig. 10.4.1-1.
 - Face material width is the following value.

$$128\sqrt{D_0\ell} \text{ (mm)}$$
 Where:
 - D₀*: Bracket throat depth (*m*)
 - ℓ*: Bracket free edge length (*m*)
- (c) Side frames directly beneath the hatchway at both ends are to be appropriately reinforced.
- (d) Sufficient attention is to be paid to the dimensions and arrangements of tripping brackets for members with large protruding parts into holds such as deep side frames.
- (6) Watertight bulkhead protection
- Hold bulkheads of ships not greater than 130 *m* in length *L_C* are preferably not to be of a corrugated type but of a plane type. The sides of plane-type bulkheads not fitted with stiffeners and both sides of corrugated-type bulkheads are to be reinforced with square section wooden bars (about 250 *mm*²) or steel angle bars and the like placed at proper intervals. Protection of bulkhead stiffeners is to be in accordance with (5) above.
- (7) Painting
- Hull structural members below a line 300 *mm* above the tops of tank side brackets and bulkhead stiffener lower brackets (including shell plates, bulkhead plates and piping but excluding inner bottom plates, bilge hopper plates and bulkhead stool slant plates) are to be coated with either tar epoxy paint or another paint of similar quality that does not easily peel off. However, where inner bottom plates, bilge hopper plates and bulkhead stool slant plates are welded to shell plates, bulkhead plates, tank side brackets, bulkhead stiffener lower brackets, etc., welded joints and their surrounding areas are to be protected by coating.
- (8) Air pipe and other equipment protection
- Air pipes, ladders, weathertight doors and equipment fitted onto hull structural members which are liable to sustain damage due to the impact of cargo are to be properly protected.
- (9) Hatch covers protection
- Hatch covers are to be protected from timber by protective coverings such as dunnage and are to be fitted with devices to prevent them from moving due to ship motion, such as rolling, pitching, etc. Where hatch covers have gaskets, devices are to be provided for preventing the gaskets from sustaining excessive compression due to timber loads.
- (10) Timber deck cargo arrangement
- Timber deck cargo stowage heights, lashing arrangements and securing arrangements are to be in accordance with the “International Convention on Load Lines, 1996 and Protocol of 1988 relating to the International Convention on Load Lines, 1966”. Where the buoyancy of the timber deck cargo is taken into account with regard to damage stability, uprights are to be in accordance with 2.3.2.3-12(1)(c), Part 1.

Fig. 10.4.1-1

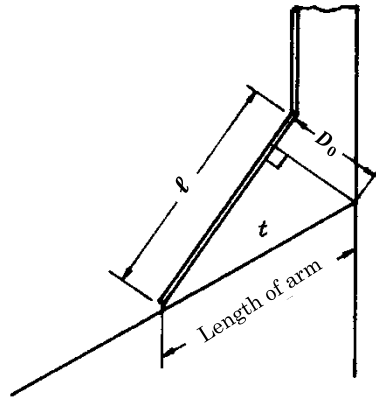

10.5 Additional Requirements for Self-Unloading Ships

10.5.1 General

10.5.1.1 Application

Self-unloading ships specified in **1.3.1(19), Part B** are to be in accordance with the following (1) to (3).

- (1) **14.6, Part 1, 3.2** and **11.1, Part 2-3**, are to be applied.
- (2) The side frames of self-unloading ships with single-side structures in cargo hold areas are to comply with *IACS* Unified Requirement S12, as may be amended.
- (3) For self-unloading ships to which **Annex 1.1 “Additional Requirements for Bulk Carriers in Chapter XII of the SOLAS Convention”, Chapter 1, Part 2-2** applies according to **1.1.1.2**, regardless of Annexes **An3**. and **An5**. when applying said **Annex 1.1, Part 2-2**, in cases where self-unloading ships with unloading systems that do not maintain watertightness, the combination loads acting on the bulkheads in the flooded conditions are to be considered using the extent to which the flooding may occur.

Part 2-6 VEHICLES CARRIERS AND ROLL-ON/ROLL-OFF SHIPS

Chapter 1 GENERAL

1.1 General

1.1.1 Application

1.1.1.1 Application of this Part

1 The hull construction and equipment of ships intended to be registered as vehicles carriers, affixed with the notation “*Vehicles Carrier*” (abbreviated as *VC*) or roll-on/roll-off ships affixed with the notation “*Roll on-Roll off*” (abbreviated as *RORO*), are to be in accordance with the requirements in **Part 2-6** in addition to **Part 1**.

2 The requirements in **Part 2-6** are for ships with multiple decks that having cargo spaces not normally subdivided in any way and normally extending to either a substantial length or the entire length of the ship in which cargoes can be loaded and unloaded normally in a horizontal direction.

3 Vehicles carriers or roll-on/roll-off ships with a different construction from that specified in -2 above, to which the requirements in this Part are considered to be not applicable, are to be at the discretion of the Society.

1.2 Definitions

1.2.1 Naming Convention

1.2.1.1 Structural Nomenclature

Fig. 1.2.1-1 show the common structural nomenclature used in **Part 2-6**.

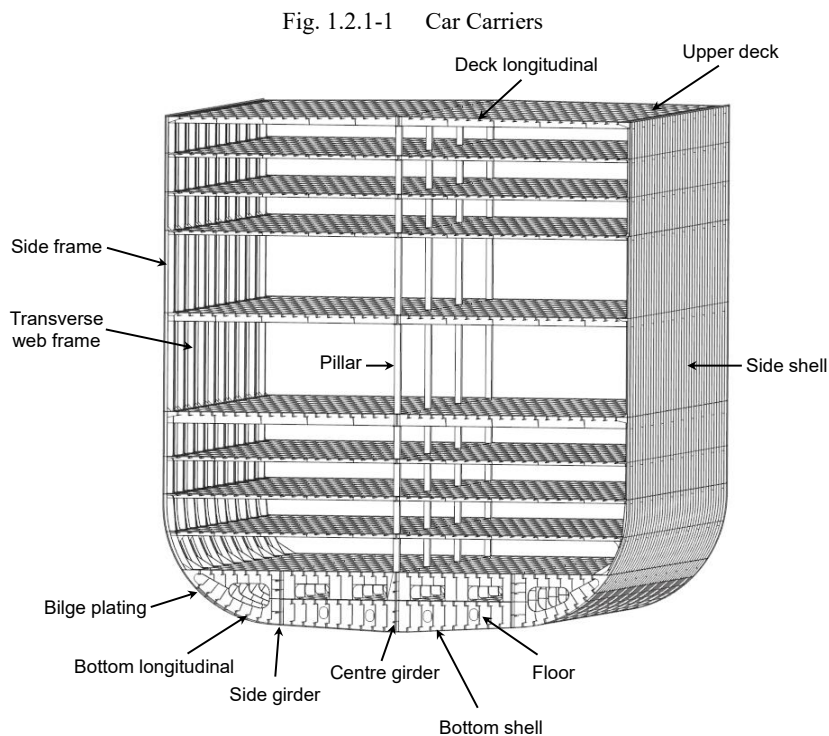

Chapter 3 STRUCTURAL DESIGN PRINCIPLES

3.1 Minimum Requirements

3.1.1 Minimum Thickness

3.1.1.1 Shell Plating in way of Superstructures

The minimum thickness requirements specified in **3.5.1.1, Part 1** need not be applied to shell plating from a height twice the height h_s above the freeboard deck to the strength deck. However, the thickness of such plating is not to be less than 5.5 mm.

3.1.1.2 Structures in Cargo Spaces

For structural members above the freeboard deck in cargo spaces, the minimum thickness requirements in **3.5.1.3, Part 1** need not be applied.

3.1.1.3 Car Deck

The minimum thickness requirements specified in **3.5.1, Part 1** need not be applied to the plates, stiffeners and girders of car decks loaded solely with wheeled vehicles. However, the gross thicknesses of deck plates, and the webs and flanges of stiffeners attached to decks are not to be less than 5 mm.

3.1.2 Slenderness Requirements

3.1.2.1 Shell Plating

The thickness of shell plating of superstructure is not to be less than that obtained from the following formula.

Shell plating of transverse framing system:

$$t = b \sqrt{\frac{\sigma_Y}{E}} \left(0.9 - \sqrt{0.81 - \frac{0.8\sigma_{min}}{\sigma_Y}} \right)$$

Shell plating of longitudinal framing system:

$$t = b \sqrt{\frac{\sigma_Y}{E}} \cdot \left(\frac{0.06\alpha + 2.19 - \sqrt{(0.06\alpha + 2.19)^2 - \frac{2\alpha\sigma_{min}(3.7 - 1.2\alpha)}{\sigma_Y}}}{3.7 - 1.2\alpha} \right)$$

a : Length (mm) of the longer side of plate

b : Length (mm) of the shorter side of plate

α : Aspect ratio, to be taken as a/b

σ_{min} : Minimum vertical proof stress considered, to be taken as:

Shell plating below the midpoint between the freeboard deck and upper deck: 50 (N/mm²)

Shell plating above the midpoint between the freeboard deck and upper deck: 30 (N/mm²)

Fig. 3.1.2-1 Minimum Vertical Proof Stress Considered

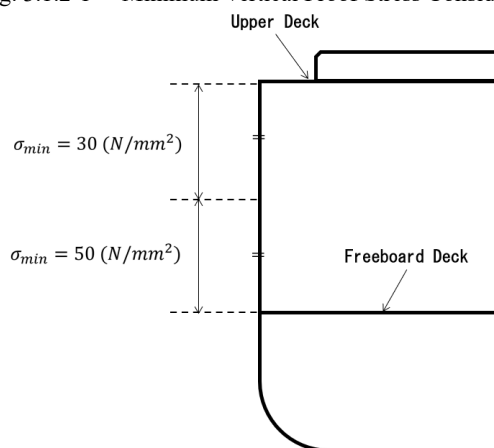

3.1.2.2 Car Decks

The slenderness requirements specified in [3.5.2, Part 1](#) need not be applied to the plates, stiffeners and girders of car decks loaded solely with wheeled vehicles.

3.2 Loading Manual and Loading Computer

3.2.1 Loading Manual

3.2.1.1 Additional Requirements for the Loading Manual

The following matters are to be included in the loading manual.

- (1) Tolerable cargo weight of the car deck and ramp way
- (2) For ships undergoing a strength assessment as part of a whole ship analysis performed in accordance with the requirements of [Chapter 8](#), where said strength assessment is performed with a completely filled ballast tank to account for ballast conditions, the loading manual are to note that the loading condition of the ballast tank are to be kept completely filled at all times as part of operational restrictions

Chapter 4 LOADS

4.1 General

4.1.1 Overview

4.1.1.1 Structure and Overview of this Chapter

Each section of this Chapter defines the additional requirements shown in **Table 4.1.1-1** as the loads used for each formula and each strength assessment to determine the structural dimensions specified in each Chapter of **Part 2-6** and **Part 1**.

Table 4.1.1-1 Overview of Chapter 4

Section	Title	Overview
4.1	General	Requirements for the general principles of Chapter 4
4.2	Loads to be Considered in Local Strength	Additional requirements for various loads to be considered in the local strength requirements specified in Chapter 6 and Chapter 6, Part 1 .
4.3	Loads to be Considered in Strength of Primary Supporting Structures	Additional requirements for various loads to be considered in the primary supporting structural strength requirements specified in Chapter 7 and Chapter 7, Part 1 .
4.4	Loads to be Considered in Strength Assessment of the Bottom Construction by Whole Ship Analysis	Load requirements to consider in performing a strength assessment of the bottom construction by whole ship analysis among the strength assessment requirements by cargo hold analysis specified in Chapter 8 .
4.5	Loads to be Considered in Racking Strength Assessment by Whole Ship Analysis	Load requirements to consider in performing a racking strength assessment by whole ship analysis among the strength assessment requirements by cargo hold analysis specified in Chapter 8 .
4.6	Loads to be Considered in Fatigue Strength Assessment by Whole Ship Analysis	Additional requirements for loading conditions to be considered in the requirements for fatigue strength assessment by whole ship analysis specified in Chapter 9 .
4.7	Loads to be Considered in Additional Structural Requirements	Additional requirements for loads to be considered in the additional structural requirements specified in Chapter 10 and Chapter 10, Part 1 .

4.2 Loads to be Considered in Local Strength

4.2.1 General

4.2.1.1 General

1 The loads to be considered in the local strength requirements specified in **Chapter 6** and **Chapter 6, Part 1** are also to be in accordance with the requirements of **4.2**.

2 Additional requirements for loads in the maximum load condition are to be in accordance with the requirements of **4.2.2**.

4.2.2 Maximum Load Condition

4.2.2.1 Lateral Loads

1 In considering internal pressure due to cargo, the requirements of 4.7.2 are to be applied instead of the requirements specified in 4.4.2, Part 1. Further, loads specified in 4.7.2 are not to be applied to the requirements of Chapter 6 and Chapter 6, Part 1, and the requirements of Chapter 10 are to be applied instead.

2 In applying 4.4.2.4, Part 1, the parameters (GM , z_G etc.) required to calculate the dynamic pressure due to ballast water are to be the values in the ballast condition. The same parameters are to be applied where the dynamic pressure due to liquid other than ballast water, such as the pressure due to fuel oil tank, is considered. However, the values in Table 4.2.2-1 may be used if the parameters are not available.

Table 4.2.2-1 Simplified Formulae for Parameters

Loading condition	Draught $T_{LC}(m)$ amidships	Z coordinate $z_G (m)$ of the centre of gravity of the ship	Metacentric height $GM(m)$	Radius of gyration $K_{xx} (m)$
Ballast condition	T_{BAL}	$0.20 \frac{B}{C_{B_LC}}$	$\frac{T_{LC}}{2} + \frac{B^2}{T_{LC}C_{B_LC}} \frac{3C_{W_LC} - 1}{24} - z_G$	$0.40B$

4.3 Loads to be Considered in Strength of Primary Supporting Structures

4.3.1 General

4.3.1.1 General

1 The loads to be considered in the requirements for the strength of the primary supporting structures specified in Chapter 7 and Chapter 7, Part 1 are to be in accordance with the requirements of 4.3.

2 Additional requirements for loads in the maximum load condition are to be in accordance with the requirements of 4.3.2.

3 The loads in the harbour condition may not be considered.

4.3.2 Maximum Load Condition

4.3.2.1 General

1 The requirements for simple girders are also to be in accordance with the relevant requirements of 4.2.

2 For the requirements of double hull, the loads specified in Table 4.3.2-1 are to be considered. However, where deemed necessary by the Society, additional loading pattern that takes into account the loading condition described in the loading manual may be required.

Table 4.3.2-1 Loads to be Considered in Maximum Load Condition

Structures to be assessed		Loading patterns			Equivalent design wave	Difference between external and internal pressure to be considered (kN/m^2)
		Draught(m)	Vertical still water bending moment ($kN-m$)	Loaded to be considered		
Double bottom	S1	$0.7T_{SC}$	$M_{SV \max}$	None	HM-1 / HM-2	Double bottom: P_{DB} Double side: P_{DS}
Double side	S2	T_{SC}	$M_{SV \min}$	Cargo	BP-1P / BP-1S	
	S3	T_{SC}	$M_{SV \min}$	Cargo		

4.3.2.2 External Pressure

For the requirements of double hull, the hydrostatic pressure and the hydrodynamic pressure at the equivalent design wave specified in [Table 4.3.2-2](#) are to be considered.

Table 4.3.2-2 External and Internal Pressure to be Considered

Structures to be assessed		$P_{DB}(kN/m^2)^{(1)(2)}$	$P_{DS}(kN/m^2)^{(1)(2)}$
Double bottom	S1 ⁽³⁾	$P_{exs} + P_{exw}$	$P_{exs} + P_{exw}$
Double side	S2	$P_{exs} + P_{exw} - P_{in_s2}$	$P_{exs} + P_{exw}$
	S3	$P_{exs} + P_{exw} - P_{in_s3}$	$P_{exs} + P_{exw}$
Notes: P_{exs} , P_{exw} : Hydrostatic and Hydrodynamic pressure (kN/m^2) act on bottom shell in case of P_{DB} . Those values act on side shell in case of P_{DS} . Each value is calculated in accordance with 4.6.2.4, Part 1 . P_{in_s2} , P_{in_s3} : The values considering the effect due to cargo (kN/m^2), as given by the following formulae: $P_{in_s2} = 0.5\rho g T_{SC}$ $P_{in_s3} = \rho g T_{SC}$			
(1) Load calculation points are to be in accordance with 7.3.1.5, Part 1 for all loading conditions. (2) When calculating loads, $T_{LC} = 0.7T_{SC}$ for S1 and $T_{LC} = T_{SC}$ for S2 and S3. (3) P_{exw} is to be not less than the value of P_{exw} for HM-2 at x_G , which is the X coordinate (m) at the centre of gravity of the ship.			

4.3.2.3 Internal loads

For the requirements of double hull, internal loads according to [Table 4.3.2-2](#) are to be considered.

4.3.2.4 Vertical Bending Moment

1 For the requirements of double hull, the vertical still water bending moment and the vertical wave bending moment in the equivalent design wave specified in [4.3.2.1-2](#) are to be considered.

2 The vertical wave bending moment considered for each equivalent design wave is to be in accordance with [4.6.2.10, Part 1](#).

4.4 Loads to be Considered in Strength Assessment of the Bottom Construction by Whole Ship Analysis

4.4.1 General

4.4.1.1 General

For the requirements of strength assessment of the bottom construction specified in [8.4](#), the loads specified in the maximum load condition specified in [4.4.2](#) are to be considered.

4.4.2 Maximum Load Condition

4.4.2.1 Loading Conditions

1 Of the designed standard loading conditions described in the loading manual, the loading conditions specified in [Table 4.4.2-1](#) are to be considered.

2 Where deemed necessary by the Society, loading conditions not specified in this Chapter may be required additionally.

Table 4.4.2-1 Loading Conditions to be Considered in Maximum Load Condition

Loading condition	Loading pattern		Draught T_{LC} (m)	Vertical still water bending moment $M_{SV}(kN)$ to consider	Equivalent design wave
Standard full load condition	S1	Ballast tank: Empty ⁽¹⁾ Fuel oil tank: Empty	T_{SC}	M_{SV_max}	<i>HMM-2</i>
Ballast condition	S2	Ballast tank: Full ⁽²⁾ Fuel oil tank: Empty	T_{BAL}	M_{SV_max}	<i>HMM-2</i>

Notes:

(1) While in a standard full load condition, ballast tanks in constant use while at sea can be considered to be loaded with ballast.

(2) If the ballast tank is partially filled or empty by design, strength assessments are to be carried out with the ballast tank empty to account for ballast conditions. When performing strength assessments with fully loaded ballast tank to account for ballast conditions, the loading manual are to note that the ballast tank is to be kept fully loaded at all times as an operational restriction.

4.4.2.2 Wave Conditions

- 1 Loads based on equivalent design wave *HMM-2* are to be considered.
- 2 Where deemed necessary by the Society, additional equivalent design waves other than -1 above may be required.

4.4.2.3 External Pressure

1 The external pressure acting on outer shell P_{ex} (kN/m^2) is to be calculated according to the following formula. However, it is not to be less than 0.

$$P_{ex} = P_{exs} + P_{exw}$$

P_{exs} : Hydrostatic pressure (kN/m^2), as specified in 4.4.2.3-2

P_{exw} : Hydrodynamic pressure (kN/m^2), as specified in 4.4.2.3-3

2 The hydrostatic pressure P_{exs} (kN/m^2) corresponding to the draught T_{LC} (m) for the loading condition under consideration is to be considered.

3 The hydrodynamic pressure P_{exw} (kN/m^2) for the equivalent design wave *HMM-2* specified in Table 4.4.2-2 and Fig. 4.4.2-1 is to be considered. Further, the hydrodynamic pressure of the wave is to be applied to the entire area in the longitudinal direction.

Table 4.4.2-2 Hydrodynamic Pressure for the Equivalent Design Wave H_{Mm-2} , P_{exw}

	Hydrodynamic pressure P_{exw} (kN/m^2)		
	$z \leq T_{LC}$	$T_{LC} < z \leq T_{LC} + h_W$	$z > T_{LC} + h_W$
H_{Mm-2}	$P_{exw} = \max(P_{H_{Mm}}, \rho g(z - T_{LC}))$	$P_{WL} - \rho g(z - T_{LC})$	0

Notes:

$P_{H_{Mm}}$: As given by the following formula:

$$P_{H_{Mm}} = 0.5C_{R_{HM}}C_{NL_{HM}}C_M C_{HM1}H_{S_{HM}}(P_{H_{Mm1}} + P_{H_{Mm2}})$$

$C_{R_{HM}}$: Coefficient considering the effect of ship operation, to be taken as 0.85

$C_{NL_{HM}}$: Coefficient considering nonlinear effects, to be taken as 0.9

C_M : Coefficient for maximum wave height, to be taken as 1.9

C_{HM1} : Correction coefficient to regular wave height, as given by the following formula.

$$C_{HM1} = 0.14L_C^{0.28}$$

$H_{S_{HM}}$: Significant wave height (m), as given by the following formula but not to be less than 2.0.

$$H_{S_{HM}} = -0.21T_{Z_{HM}}^2 + 5.07T_{Z_{HM}} - 15.7$$

$T_{Z_{HM}}$: Average zero up crossing wave period (s), as given by the following formula.

$$T_{Z_{HM}} = 0.71 \sqrt{\frac{2\pi\lambda_{HM}}{g}} + 2.5$$

λ_{HM} : Wavelength (m) in the equivalent design wave under consideration, as given by the following formula:

$$\lambda_{HM} = (0.91 + 0.24f_T)L_C C_{W_{LC}}$$

$P_{H_{Mm1}}$: As given by the following formula:

$$P_{H_{Mm1}} = \rho g \cdot \exp\left[\frac{2\pi}{\lambda_{HM}}(z - T_{LC})\right]$$

$P_{H_{Mm2}}$: As given by the following formula:

$$P_{H_{Mm2}} = \rho g |R_{3_{HM}}| (6.0 \cdot 10^{-4} \cdot L_C C_{W_{LC}} - 1.03)$$

$R_{3_{HM}}$: As given by the following formula:

$$R_{3_{HM}} = 116.4 \left(\frac{T_{LC}}{L_C}\right)^{1.95}$$

P_{WL} : Hydrodynamic pressure (kN/m^2) at the waterline in the equivalent design wave to be considered, to be taken as:
 For $y \geq 0$, the value of P_{exw} at $y = B_{x1}/2$ and $z = T_{LC}$
 For $y < 0$, the value of P_{exw} at $y = -B_{x1}/2$ and $z = T_{LC}$

B_{x1} : Moulded breadth of a ship at the waterline at the draught in the cross section to be considered (m).

h_W : Water head (m) equivalent to the pressure at the waterline, as given by the following formula:

$$h_W = \frac{P_{WL}}{\rho g}$$

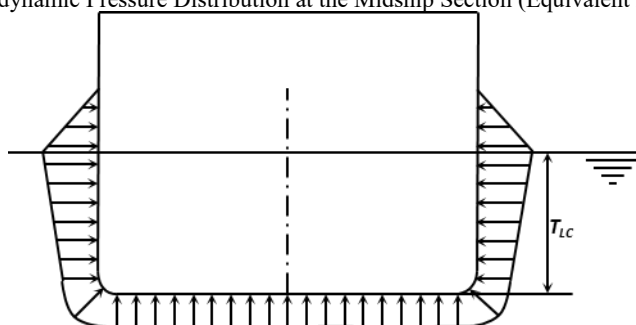
 Fig. 4.4.2-1 Hydrodynamic Pressure Distribution at the Midship Section (Equivalent Design Wave H_{Mm-2})

4.4.2.4 Internal Pressure and Cargo Load

1 The cargo load acting on the decks P_{CDK} (kN/m^2) and the pressure due to the ballast P_{Is} (kN/m^2) are to be considered in accordance with the loading conditions under consideration. However, only the load weight acting in still water is to be considered, without considering the dynamic load due to ship motion and acceleration.

2 The cargo load P_{CDK} (kN/m^2) is to be considered as a distributed load acting uniformly on the car deck as specified in **Table 4.4.2-3**. The direction of P_{CDK} is to be in accordance with the coordinate system specified in **1.4.3.6, Part 1**.

 Table 4.4.2-3 Cargo Load P_{CDK}

	Cargo Load P_{CDK} (kN/m^2)
Car Deck ⁽¹⁾	$-W_{wh,i}/A_i$
Notes:	
$W_{wh,i}$:	The weight of the vehicle (kN) loaded onto the car deck i in the loading condition to be considered.
i :	A suffix representing the height position of the car deck.
A_i :	The area of the corresponding car deck (m^2).
(1) The weight of the cargo loaded onto each car deck is to be assumed to be evenly distributed across the deck and given a uniform distributed load.	

3 When loading cargo onto a movable car deck, the weight of the movable car deck itself W_{LCDK} (kN) and the weight of the vehicles loaded onto the car deck $W_{wh,LCDK}$ (kN) are to be considered. Where storing the movable car deck, the weight of the deck itself W_{LCDK} (kN) is to be considered.

4 The load due to ballast water P_{Is} (kN/m^2) is to be in accordance with **Table 4.4.2-4**.

 Table 4.4.2-4 Static Pressure of the Ballast Tank P_{Is}

Types of tanks	Static pressure P_{Is} (kN/m^2)	
	$z \leq z_{top}$	$z > z_{top}$
Ballast tank	$\rho g(z_{top} - z)$	0
Notes:		
z_{top} : The Z-coordinate of the highest point in the tank, excluding the small hatchway (m).		

4.4.2.5 Weight of the Hull Structure, etc.

1 The effect of the weight of the hull structure is to be considered.

2 Where deemed appropriate by the Society, the effect of the equipment and the permanent ballast may be considered. It may be considered as distributed load.

4.4.2.6 Hull Girder Loads

The vertical bending moment acting on the hull M_{V-HG} ($kN-m$) is to be obtained from the following formula.

$$M_{V-HG} = M_{SV} + M_{WV-h} \quad (kN-m)$$

M_{SV} : As specified in **4.4.2.1**.

M_{WV-h} : The vertical wave bending moment in a hogging condition ($kN-m$), as given by the following formula.

$$M_{WV-h} = 0.19C_1C_2L_c^2BC_{B1}$$

C_2 : As specified in **Table 4.4.2-5**. The mean value is calculated by linear interpolation.

 Table 4.4.2-5 Coefficient of Distribution along the Ship Length, C_2

x/L_c	C_2
$x/L_c < 0$	0.0
$x/L_c = 0.4$	1.0
$x/L_c = 0.65$	1.0
$x/L_c \geq 1.0$	0.0

4.5 Loads to be Considered in Racking Strength Assessment by Whole Ship Analysis

4.5.1 General

4.5.1.1 General

Where racking strength assessment as specified in 8.5 is carried out, the loads in the maximum load condition specified in 4.5.2 are to be considered.

4.5.2 Maximum Load Condition

4.5.2.1 Loading Conditions

In principle, The condition where passenger cars fully are loaded is to be considered. However, additional loading conditions are to be considered when there are loading conditions that result in a larger racking deformation than the loading condition .

4.5.2.2 Wave Conditions

- 1 Loads based on the equivalent design wave specified in Table 4.5.2-1 are to be considered.
- 2 Where deemed necessary by the Society, additional equivalent design waves other than -1 above may be required.

Table 4.5.2-1 Load Cases to be Considered

Equivalent design wave		Heading	Typical Features	
<i>BR</i>	<i>BR-1P</i>	Beam sea	Port side: weather side down	Minimum roll angle
	<i>BR-2P</i>	Beam sea	Port side: weather side up	Maximum roll angle
	<i>BR-1S</i>	Beam sea	Starboard side: weather side down	Maximum roll angle
	<i>BR-2S</i>	Beam sea	Starboard side: weather side up	Minimum roll angle

4.5.2.3 External Pressure

1 The external pressure acting on outer hull P_{ex} (kN/m^2) is to be calculated in accordance with the following formula. However, it is not to be less than 0.

$$P_{ex} = P_{exs} + P_{exw}$$

P_{exs} : Hydrostatic pressure (kN/m^2), as specified in 4.5.2.3-2.

P_{exw} : Hydrodynamic pressure (kN/m^2), as specified in 4.5.2.3-3.

2 The hydrostatic pressure P_{exs} (kN/m^2) corresponding to the draught T_{LC} for the loading condition under consideration is to be considered.

3 The hydrodynamic pressure P_{exw} (kN/m^2) for the equivalent design wave *BR* specified in 4.6.2.4, Part 1 is to be considered.

4.5.2.4 Internal Pressure and Cargo Load

1 In addition to the weight of the cargo (vehicles), the dynamic loads due to the ship motion is to be considered.

2 The internal pressure P_{in} (kN/m^2) acting on each car deck is to be in accordance with the following formula. However, the value is not to be greater than 0 (that is, not to be the value where the direction of P_{in} is upward). Further, the direction of P_{in} is to be in accordance with the coordinate system specified in 1.4.3.6, Part 1.

$$P_{in} = P_{CDK} + P_{CDKa}$$

P_{CDK} : The distributed load acting on the car deck in still water (kN/m^2), in accordance with the requirements of Table 4.5.2-2. The load is assumed to be distributed evenly over the car deck.

P_{CDKa} : The dynamic load (kN/m^2) acting on the car deck in wave, as given by the following formula:

For components acting in transverse direction, $P_{CDKa} = P_{CDKa-T}$

For components acting in vertical direction, $P_{CDKa} = P_{CDKa-V}$

P_{CDKa-T} , P_{CDKa-V} : As specified in Table 4.5.2-3.

3 Where loading cargo onto a movable car deck, the weight of the movable car deck itself W_{LCDK} (kN) and the weight of the vehicles loaded W_{wh_LCDK} (kN) are to be considered. The dynamic load in waves is also be taken into consideration. Further, when storing a movable car deck, the weight of the deck itself W_{LCDK} (kN) is to be considered.

Table 4.5.2-2 Cargo Load P_{CDK}

	Cargo load P_{CDK} (kN/m^2)
Car deck ⁽¹⁾	$-W_{Wh,i}/A_i$
Notes:	
$W_{Wh,i}$:	The weight of the vehicle (kN) loaded onto the car deck i in the loading condition under consideration.
i :	A suffix representing the height position of the car deck.
A_i :	The area of the corresponding car deck (m^2).
(1) The weight of the cargo loaded onto each car deck is to be assumed to be evenly distributed across the deck and given a uniform distributed load.	

 Table 4.5.2-3 Dynamic Load due to Cargo Hold P_{CDKd}

Direction under consideration ⁽¹⁾	Distributed load (kN/m^2) due to the vehicle weight
Transverse direction	$P_{CDKd-T} = -\frac{W_{Wh,i} a_Y}{A_i g}$
Vertical direction	$P_{CDKd-V} = -\frac{W_{Wh,i} a_Z}{A_i g}$
Notes:	
$W_{Wh,i}$, A_i : As specified in Table 4.5.2-2 .	
a_Y, a_Z : Accelerations in the transverse direction and vertical direction at each point on the car deck (m/s^2), calculated in accordance with Table 4.6.2-14, Chapter 4, Part 1 .	
(1) Note that the dynamic loads due to ship motions and accelerations act in the opposite direction to accelerations.	

4 Loads due to the ballast water and the fuel oil, etc. are not to be considered.

4.5.2.5 Weight of the Hull Structure, etc.

1 The effect of gravitational acceleration acting on the hull in still water is to be considered. Dynamic component due to ship motion in waves is also to be taken into consideration. Note that the dynamic component acts in the opposite direction to acceleration.

2 Where deemed appropriate by the Society, the effect of the equipment and the permanent ballast may be considered. It may be considered as distributed load.

4.6 Loads to be Considered in Fatigue Strength Assessment by Whole Ship Analysis

4.6.1 General

4.6.1.1 General

Where performing fatigue strength assessment by Finite Element Analysis using the whole ship model specified in [Chapter 9](#), the loads specified in the cyclic load condition specified in [4.6.2](#) are to be considered.

4.6.2 Cyclic load Condition

4.6.2.1 Loading Conditions

1 In principle, the condition where passenger cars fully loaded and ballast condition are to be considered.

2 Of the loading conditions designed to occur over an extended period of time, loading conditions that greater racking deformation occurs than the condition passenger cars fully loaded as selected in -1 above are to be considered as additional loading conditions.

4.6.2.2 Wave Conditions

1 Loads based on the equivalent design wave specified in [Table 4.6.2-1](#) are to be considered.

2 Where deemed necessary by the Society, additional equivalent design waves other than -1 above may be required.

Table 4.6.2-1 Load Cases to be Considered

Equivalent design wave		Heading	Typical Features	
BR	BR-1P	Beam sea	Port side: weather side down	Minimum roll angle
	BR-2P	Beam sea	Port side: weather side up	Maximum roll angle
	BR-1S	Beam sea	Starboard side: weather side down	Maximum roll angle
	BR-2S	Beam sea	Starboard side: weather side up	Minimum roll angle

4.6.2.3 External Pressure

1 The external pressure acting on outer shell P_{ex} (kN/m^2) is to be obtained from the following formula. However, it is not to be less than 0.

$$P_{ex} = P_{exs} + P_{exw}$$

P_{exs} : Hydrostatic pressure (kN/m^2), as specified in 4.6.2.3-2.

P_{exw} : Hydrodynamic pressure (kN/m^2), as specified in 4.6.2.3-3.

2 The hydrostatic pressure P_{exs} (kN/m^2) corresponding to the draught T_{LC} for the loading condition under consideration is to be considered.

3 The hydrodynamic pressure P_{exw} (kN/m^2) for the equivalent design wave BR specified in 4.7.2.4, Part 1 is to be considered.

4.6.2.4 Internal Pressure and Cargo Load

1 In addition to the weight of the cargo (vehicles), the dynamic loads due to the ship motion are to be considered.

2 The internal pressure P_{in} (kN/m^2) acting on each car deck is to be in accordance with the following formula. However, the value is not to be greater than 0 (that is, not to be the value where the direction of P_{in} is upward). Further, the direction of P_{in} is to be in accordance with the coordinate system specified in 1.4.3.6, Part 1.

$$P_{in} = P_{CDK} + P_{CDKa}$$

P_{CDK} : The distributed load (kN/m^2) acting on the car deck in still water in accordance with the requirements of Table 4.6.2-2. The load is assumed to be distributed evenly over the car deck.

P_{CDKa} : The dynamic load (kN/m^2) acting on the car deck in waves, as given by the following formulae:

For components acting in transverse direction, $P_{CDKa} = P_{CDKa-T}$

For components acting in vertical direction, $P_{CDKa} = P_{CDKa-V}$

P_{CDKa-T} , P_{CDKa-V} : As specified in Table 4.6.2-3.

3 When loading cargo onto a movable car deck, the weight of the movable car deck itself W_{LCDK} (kN) and the weight of the vehicles loaded W_{wh_LCDK} (kN) are to be considered. The dynamic load in waves is also to be taken into consideration. Further, when storing a movable car deck, the weight of the deck itself W_{LCDK} (kN) is to be considered.

 Table 4.6.2-2 Cargo Load P_{CDK}

Car Deck ⁽¹⁾	Cargo Load P_{CDK} (kN/m^2)
	$-W_{wh_i}/A_i$
Notes:	
W_{wh_i} :	The weight of the vehicle (kN) loaded onto the car deck i in the loading condition under consideration.
i :	A suffix representing the height position of the car deck.
A_i :	The area of the corresponding car deck (m^2)
(1) The weight of the cargo loaded onto each car deck is to be assumed to be evenly distributed across the deck and given a uniform distributed load.	

Table 4.6.2-3 Dynamic Load due to Cargo P_{CDKd}

Direction accounted for ⁽¹⁾	Distributed load from the vehicle weight (kN/m^2)
Transverse direction	$P_{CDKd-T} = -\frac{W_{Wh-i} a_Y}{A_i g}$
Vertical direction	$P_{CDKd-V} = -\frac{W_{Wh-i} a_Z}{A_i g}$
Notes:	
W_{Wh-i} , A_i : As specified in Table 4.6.2-2 .	
a_Y, a_Z : Acceleration in the transverse direction and vertical direction at each point on the car deck (m/s^2), calculated based on Table 4.7.2-14, Chapter 4, Part 1 .	
(1) Note that the variable load caused by ship motion and acceleration acts in the opposite direction to acceleration.	

4 The ballast load is to be as specified in [4.7.2.5, Part 1](#).

4.6.2.5 Weight of the Hull Structure, etc.

1 The effect of gravitational acceleration acting on the hull in still water is to be considered. Further, the dynamic component due to ship motion in waves is also to be taken into consideration. Note that the dynamic component acts in the opposite direction to acceleration.

2 Where deemed appropriate by the Society, the effect of the equipment and the permanent ballast may be considered. They may be considered as distributed load.

4.7 Loads to be Considered in Additional Structural Requirements

4.7.1 General

4.7.1.1 General

1 The loads to be considered in the additional structural requirements specified in [Chapter 10](#) and [Chapter 10, Part 1](#) are also to be in accordance with the requirements of [4.7](#).

2 Additional requirements for loads in maximum load condition are to be in accordance with the requirements of [4.7.2](#).

3 Additional requirements for loads in the harbour condition are to be in accordance with the requirements of [4.7.3](#).

4.7.2 Maximum Load Condition

4.7.2.1 Load Acting on the Car Deck and Movable Car Deck

1 The concentrated loads due to the wheels of the vehicle are to be considered as loads for car decks on the stiffeners attached to the car decks, in accordance with the following formula.

$$P_{CDK} = P_{Wh-max} \cdot (1 + C_{CDK})$$

P_{Wh-max} : Designed maximum wheel load (kN). When the wheel load is given in units of t , multiply this value by 9.81.

C_{CDK} : As given by the following formula:

$$C_{CDK} = C_{WDz} \frac{a_{ze-CDK}}{g}$$

C_{WDz} : Coefficient related to load condition, as specified in [Table 4.4.2-8, Part 1](#).

a_{ze-CDK} : Envelope acceleration (m/s^2) in the vertical direction at the centre line of the car deck under consideration, obtained from the formula specified in [4.2.4.1, Part 1](#). In this case, $T_{LC} = T_{SC}$ and $\theta = a_4 = 0$. Further, the centre of gravity in the longitudinal direction of the car deck under consideration is taken as the centre of the distance between support points for stiffeners on the car deck accounted for.

2 The load to be considered in the primary supporting members attached to the movable car deck P_{LCDK} (kN/m^2) is to be in accordance with the following formula:

$$P_{LCDK} = (P_{LCDK-d} + w_{LCDK}) \cdot (1 + C_{CDK})$$

P_{LCDK-d} : Design deck load (kN/m^2)

w_{LCDK} : Deck dead weight (kN/m^2) per unit area

C_{CDK} : As specified in -1 above.

4.7.3 Harbour Condition

4.7.3.1 Load Acting on the Car Deck and Movable Car Deck

- 1 The designed maximum wheel load P_{Wh-max} is to be considered for the car deck.
- 2 The design deck load P_{LCDK_d} and deck dead weight w_{LCDK} are to be considered for the movable car deck.

Chapter 6 LOCAL STRENGTH

6.1 General

6.1.1 Application

6.1.1.1 Plates and Stiffeners of Car Deck

The plates and stiffeners of the car deck are to be in accordance with [10.1](#).

Chapter 7 STRENGTH OF PRIMARY SUPPORTING STRUCTURES

7.1 General

7.1.1 Application

7.1.1.1

For the double bottom and double-side skin structure, the requirements of the double hull structure specified in 7.3, Part 1 are to be applied. For other girder members that can be regarded as simple girders, the requirements of the simple girder specified in 7.2, Part 1 are to be applied.

7.1.1.2 Application Example of Assessment Model

1 An application example of assessment model applying 7.2 and 7.3, Part 1 is shown in Fig. 7.1.1-1.

2 For girder members deemed to be simple girders with structures different from that shown in Fig. 7.1.1-1, the boundary conditions and acting loads are to be considered, and the assessment model from Table 7.2.1-2, Part 1 is to be appropriately selected.

Fig. 7.1.1-1 Application Example of Car Carriers

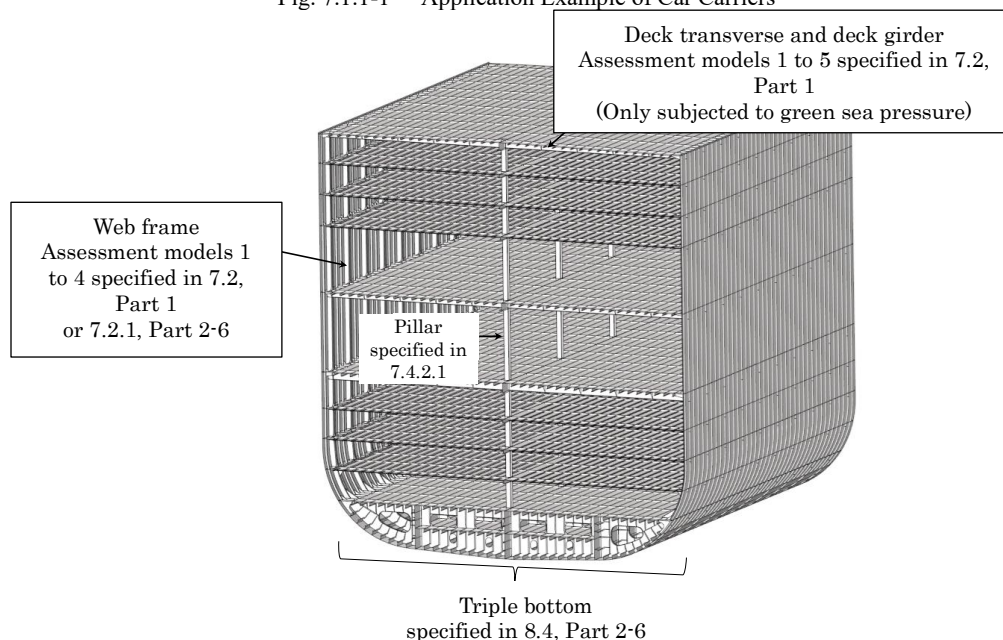

7.2 Simple Girders

7.2.1 Web Frames

7.2.1.1 Multi-Deck Ship Web Frames subject to External Pressure

In applying 7.2.3 to 7.2.5, Part 1, the bending moments and shear forces to be considered may be in accordance with the following (1) and (2), respectively. However, the values are to be 1.1 times the greater of their respective absolute values at the upper and lower ends of web frames (See Fig. 7.2.1-1).

(1) Moments acting on web frames at each node are to be in accordance with the following (a) and (b):

(a) The moment $M_{i,i-1}$ ($kN\cdot m$) acting on a web frame with node i being its upper end (the moment at the upper end of the web frame) is to be taken as follows (See Fig. 7.2.1-2):

i) For $i = n$

$$M_{n,n-1} = 0$$

ii) For $1 \leq i \leq n - 1$

$$M_{i,i-1} = \frac{1}{2}(C_{i,i-1} - C_{i,i+1} + \phi_{i-1} - \phi_{i+1})$$

(b) The moment $M_{i,i+1}$ ($kN\cdot m$) acting on a web frame with node i being its lower end (the moment at the lower end of the web frame) is to be taken as follows (See Fig. 7.2.1-2):

i) For $1 \leq i \leq n - 1$

$$M_{i,i+1} = -\frac{1}{2}(C_{i,i-1} - C_{i,i+1} + \phi_{i-1} - \phi_{i+1})$$

ii) For $i = 0$

$$M_{0,1} = -\frac{1}{4}(C_{1,2} + C_{1,0} - \phi_0 + \phi_2) - C_{0,1}$$

$C_{i,i-1}$: Coefficient to be taken as follows:

$$C_{i,i-1} = \frac{S_i \ell_i^2}{60} (3P_i + 2P_{i-1}) \quad (0 < i \leq n - 1)$$

$C_{i,i+1}$: Coefficient to be taken as follows:

i) For $0 \leq i \leq n - 2$

$$C_{i,i+1} = -\frac{S_{i+1} \ell_{i+1}^2}{60} (2P_{i+1} + 3P_i)$$

ii) For $i = n - 1$

$$C_{n-1,n} = -\frac{S_n \ell_n^2}{120} (7P_n + 8P_{n-1})$$

ϕ_i : Coefficient to be taken as follows:

i) For $i = 0$

$$\phi_0 = 0$$

ii) For $1 \leq i \leq n - 1$

$$\phi_i = -\frac{1}{4}(C_{i,i-1} + C_{i,i+1})$$

iii) For $i = n$

$$\phi_n = -\frac{1}{2}\phi_{n-1}$$

S_i : Spacing (m) of the web frame in the i -th tier from the inner bottom plating

ℓ_i : Span (m) of the web frame in the i -th tier from the inner bottom plating

P_i : Load (kN/m^2) due to the external load at node i in the maximum load condition

as specified in 4.4.2.1-1, Part 1

(2) Nodal shear forces acting on web frames are to be in accordance with the following (a) and (b):

(a) The shear force $F_{i,i-1}$ (kN) acting on a web frame with node i being its upper end (the shear force at the upper end of the web frame) is to be taken as follows:

$$F_{i,i-1} = -\frac{1}{\ell_i}(M_{i,i-1} + M_{i-1,i}) - \frac{\ell_i}{6}(2S_i P_i + S_{i-1} P_{i-1}) \quad (1 \leq i \leq n)$$

(b) The shear force $F_{i,i+1}$ (kN) acting on a web frame with node i being its lower end (the shear force at the lower end of the web frame) is to be taken as follows:

i) For $0 \leq i \leq n - 1$

$$F_{i,i+1} = -\frac{1}{\ell_{i+1}}(M_{i+1,i} + M_{i,i+1}) + \frac{\ell_{i+1}}{6}(S_{i+1}P_{i+1} + 2S_iP_i)$$

ii) For $i = 0$

$$F_{0,1} = -\frac{1}{\ell_1}(M_{1,0} + M_{0,1}) + \frac{\ell_1}{6}(S_1P_1 + 2S_0P_0)$$

$M_{1,0}$, $M_{0,1}$, $M_{i+1,i}$, $M_{i,i+1}$, ℓ_i , S_i and P_i : As specified in (1) above

Fig. 7.2.1-1 Example of Application

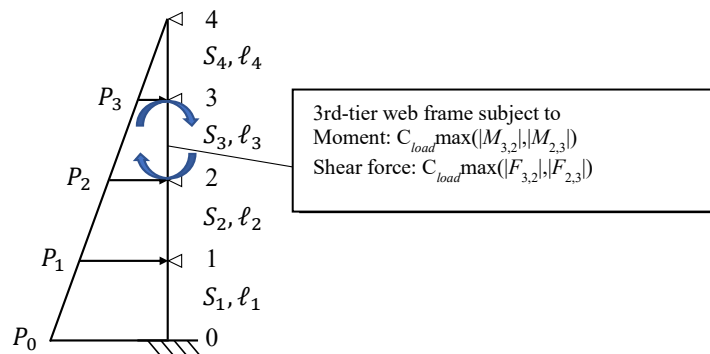
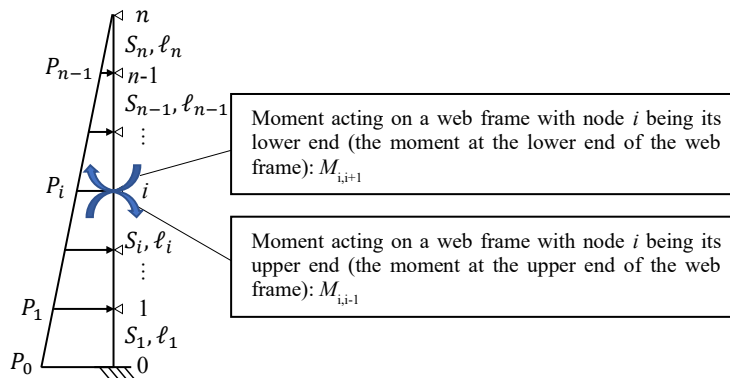

Fig. 7.2.1-2 Moment Acting on a Web Frame at Node i



Chapter 8 STRENGTH ASSESSMENT BY CARGO HOLD ANALYSIS

8.1 General

8.1.1 Overview

8.1.1.1 Structure and Overview of this Chapter

- 1 This Chapter specifies a strength assessment method for ships exclusively involved in the transport of cars, trucks, and other wheeled vehicles. This Chapter are to apply instead of the strength assessment by cargo hold analysis specified in **Chapter 8, Part 1**.
- 2 The structure and overview of this Chapter are shown in **Table 8.1.1-1**.
- 3 The standard procedure for strength assessment by whole ship analysis is specified in **Fig. 8.1.1-1**.

Table 8.1.1-1 Overview of Chapter 8

Section	Title	Overview
8.1	General	Requirements for the general principles of this Chapter
8.2	Structural Models	Extent of model, members to be modelled, meshing, etc.
8.3	Considerations for Corrosion	Net scantling approach
8.4	Strength Assessment of the Bottom Construction	Requirements concerning the scope of assessment, assessment target members, boundary conditions, load conditions, and strength criteria in a strength assessment of the bottom construction
8.5	Racking Strength Assessment	Requirements concerning the scope of assessment, assessment target members, boundary conditions, load conditions, and strength criteria in a racking strength assessment

Fig. 8.1.1-1 Flowchart of Strength Assessment by Whole Ship Analysis

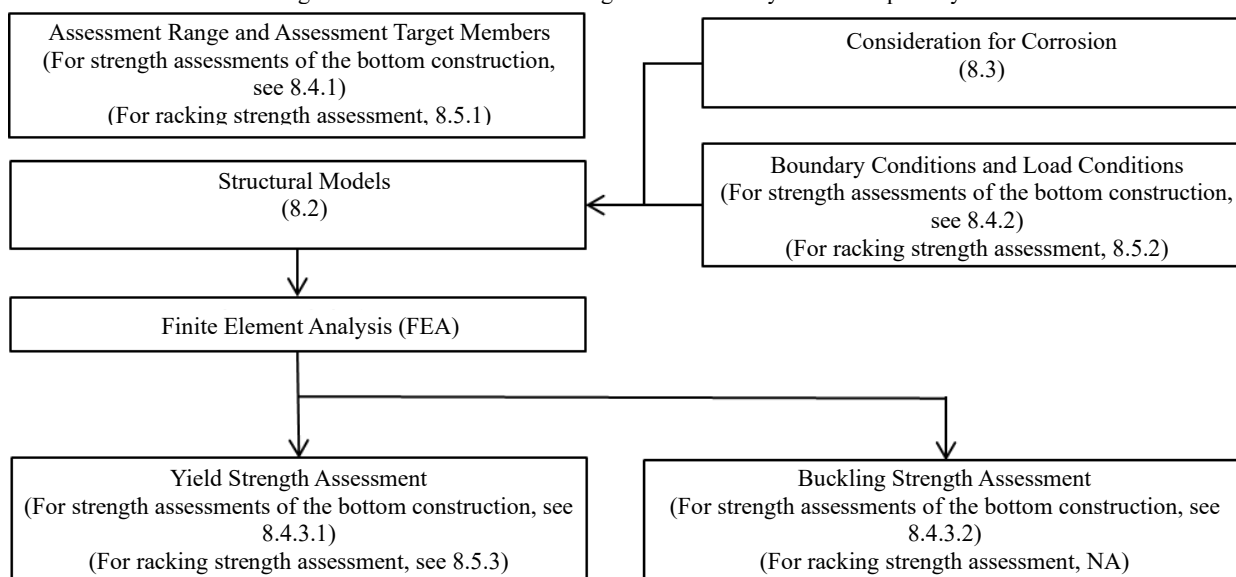

Note: Numbers in the flowchart represent the corresponding section number.

8.1.2 Application

8.1.2.1 Applicable Ships

- 1 Yield strength assessment and buckling strength assessment of the bottom construction, and yield strength assessment of

members supporting racking is to be performed in accordance with the requirements of this Chapter for ships falling under the following:

- (1) Ships exclusively involved in the transport of cars, trucks, and other wheeled vehicles.
- (2) Ships for which the assessments deemed necessary by the Society
- (3) Other ships intended to be registered with the notation “PS-DA”

2 Even if a ship does not fall under t -1(1) to (3) above, yield strength assessment and buckling strength assessment of the primary supporting structure may be performed in accordance with the requirements of this Chapter.

3 For ships with type of construction to which the requirements in this Chapter are not applicable, the requirements of this Chapter may be applied taking the ship’s characteristics, etc. into account.

8.1.3 Other General Requirements

8.1.3.1

Other general requirements are to be applied in accordance with the requirements of [8.1.3, Part 1](#).

8.2 Structural Models

8.2.1 Extent of Model and Members to be Modelled

8.2.1.1 Extent of Model

1 Extent of model is to be the entire ship. The full depth and full width are to be modelled.

2 Structures that do not affect strength assessments (superstructure, etc.) may not be modelled. However, where omitting the modelling, the distributed load equivalent to the structure is to be taken into consideration in the racking strength assessment specified in [8.5](#).

8.2.1.2 Members to be Modelled

1 Members forming the primary supporting structures are to be modelled. Models are to include stiffener attached to plate members and girders. In addition, models are also to include the car deck, and girders and stiffeners attached to the car deck.

2 Small members that affect strength assessment of the hull construction slightly may not be modelled.

8.2.2 Elements

8.2.2.1 Types of Elements

The types of elements are to be in accordance with [8.3.2.1, Part 1](#).

8.2.2.2 Element Characteristics

The characteristics of elements is to be in accordance with [8.3.2.2, Part 1](#).

8.2.3 Meshing

8.2.3.1 General

As specified in [8.3.3.1, Part 1](#). However, members outside the scope of assessment (e.g. car decks and ramp ways) may have a larger size than the typical mesh size specified herein. Mesh sizes are to be change smoothly between members to be assessed and the members with the larger mesh size.

8.2.3.2 Modelling the Openings

1 For elements around openings, in locations where application of the stress correction method specified in [8.4.3.1](#) is taken as being inappropriate, such openings are to be modelled. The openings are to be modelled by recreating opening’s shape or removing the appropriate element in consideration of size and position of the openings.

2 For models used in racking strength assessments specified in [8.5](#), other openings used to transport vehicles such as ramp ways, and other openings where contribution to racking deformation cannot be ignored (for example, ducts and stairs) are also to be modelled. Further, openings and manholes in the web of primary supporting members may be omitted from models where deemed appropriate by the Society.

8.2.3.3 Modelling Brackets

The modelling of brackets is to be in accordance with [8.3.3.3, Part 1](#).

8.2.3.4 Local Models

Local models are to be in accordance with [8.3.3.5, Part 1](#).

8.3 Consideration for Corrosion

8.3.1 Net Scantling Approach

8.3.1.1

The net scantling approach specified in 3.3, Part 1 is to be applied to members to be assessed in strength assessments of the bottom construction specified in 8.4 with regard to the plate thickness in structural models and buckling strength assessments specified in 8.4.3.2. The gross scantling is to be applied in members other than the above.

8.4 Strength Assessment of the Bottom Construction

8.4.1 Evaluation Area and Members to be Assessed

8.4.1.1 Evaluation Area

The strength assessment of the bottom construction are to be applied to the bottom construction of cargo region shown in Fig. 8.4.1-1 (double bottom or triple bottom structures).

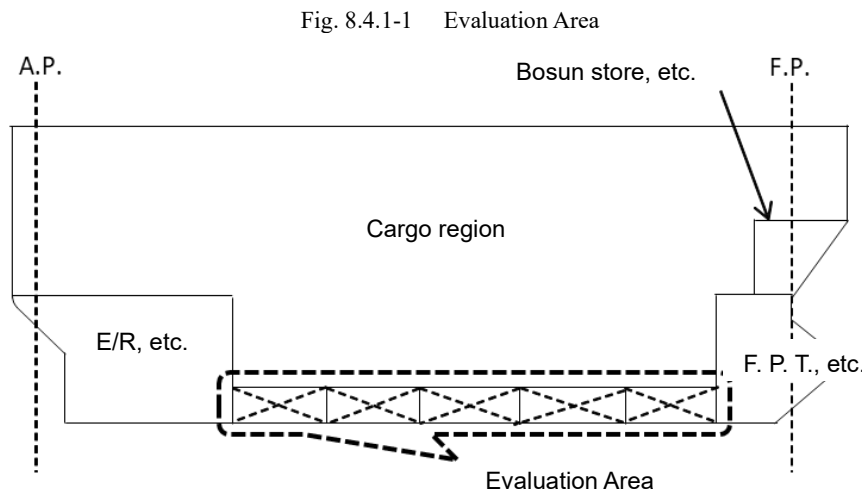

8.4.1.2 Members to be Assessed

The following members within the evaluation area are to satisfy the strength criteria specified in 8.4.

- (1) Bottom shell
- (2) Inner bottom plating and triple bottom tank top plate
- (3) Bottom girder
- (4) Floor
- (5) Other members deemed necessary by the Society

8.4.2 Boundary Conditions and Loads Conditions

8.4.2.1 General

In strength assessment of the bottom construction, the analysis in which the lateral loads are applied and the analysis in which the vertical bending moment is applied are to be performed separately. And yield strength assessment and buckling strength assessment are to be carried out based upon superimposition of the stresses obtained from these analyses.

8.4.2.2 Boundary Conditions

1 Where analysis in which the lateral loads are applied is carried out, the boundary conditions are to be in accordance with the following (1) to (3) as shown in Fig. 8.4.2-2.

- (1) Displacement in the longitudinal and transverse directions is to be restrained at the aft end of the ship. Displacement in the transverse direction is to be restrained at the fore end of the ship.
- (2) If there is a ramp way at the stern of the ship, the aft end of side shell is to be fixed.
- (3) Displacement in the vertical direction at the intersection between the garage deck and the side shell is to be restrained.

- 2 When analysis in which the vertical bending moment is applied, around both ends of ship are fixed as shown in Fig. 8.4.2-2.

Fig. 8.4.2-2 Boundary Condition and loads application

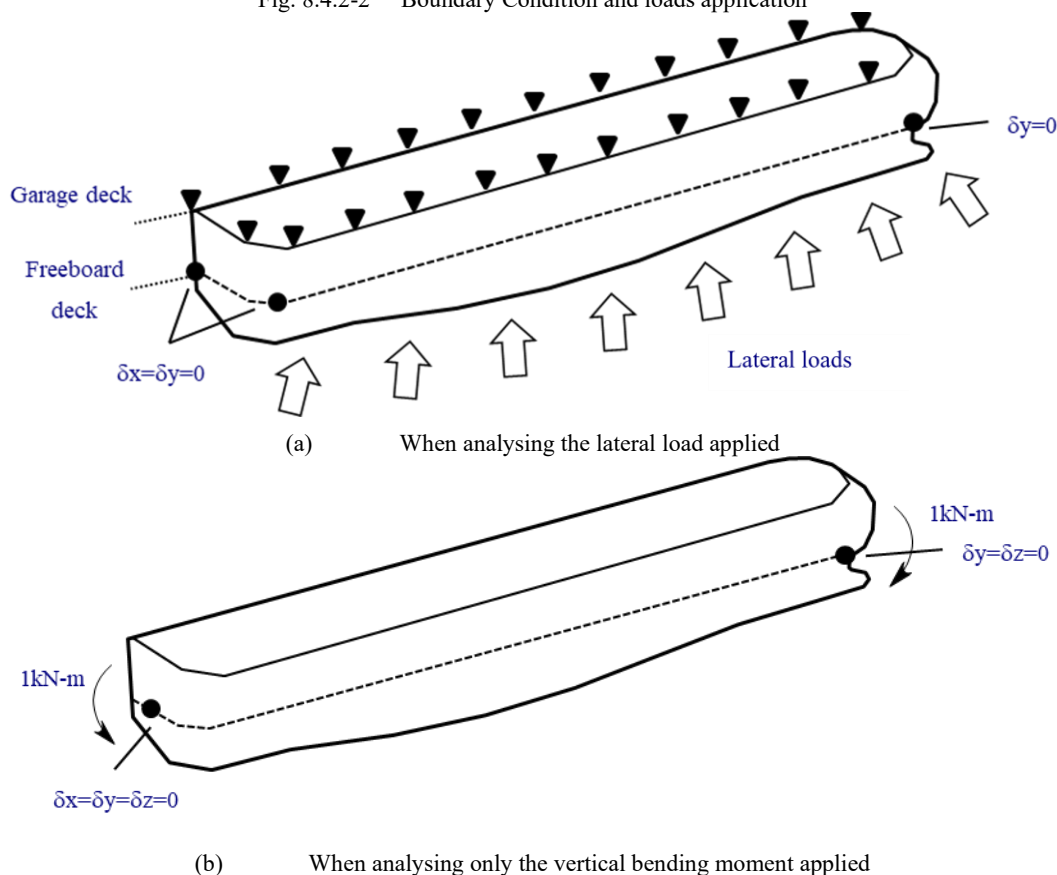

8.4.2.3 Loads Conditions

1 Loads based on 4.4 are to be considered. When analysing the lateral load applied, the external pressure, internal pressure, weight of hull structure, etc. specified in 4.4.2.3, 4.4.2.4 and 4.4.2.5 are to be considered. When analysing the vertical bending moment applied, the vertical bending moment specified in 4.4.2.6 is to be considered.

2 For external pressure, and internal pressure due to liquid, a constant pressure calculated at the element's centroid is to be applied to the shell element of the loaded surface (e.g. outer shell for external pressure and tank or cargo hold boundaries for internal pressure).

3 The weight of the cargo loaded onto the car deck is to be assumed to be evenly distributed across the deck and given as the distributed load for the car deck.

4 When cargo is loaded onto a movable deck, the dead weight of the movable car deck and the cargo weight shared across each panel are to be given as the nodal load at the movable deck support point.

5 When a movable deck is stored, the weight of the movable car deck is to be given as the nodal load to the panel storage point.

6 When analysing the vertical bending moment applied, the method applying unit moments is to be used as standard. The stresses corresponding to the moments specified in 4.4.2.6 are to be calculated based on the stresses obtained through structural analysis with unit moments applied.

7 When analysing the vertical bending moment applied, the weight of the hull structure and other factors are not to be considered.

8.4.3 Strength Assessment

8.4.3.1 Yield Strength Assessment

Yield strength assessment is to be carried out in accordance with 8.6.1, Part 1.

8.4.3.2 Buckling Strength Assessment

Buckling strength assessment is to be carried out in accordance with 8.6.2, Part 1.

8.5 Racking Strength Assessment

8.5.1 Evaluation Area and Members to be Assessed

8.5.1.1 Evaluation Area

Racking strength assessment is to be applied to the cargo region shown in [Fig. 8.5.1-1](#).

Fig. 8.5.1-1 Evaluation Area

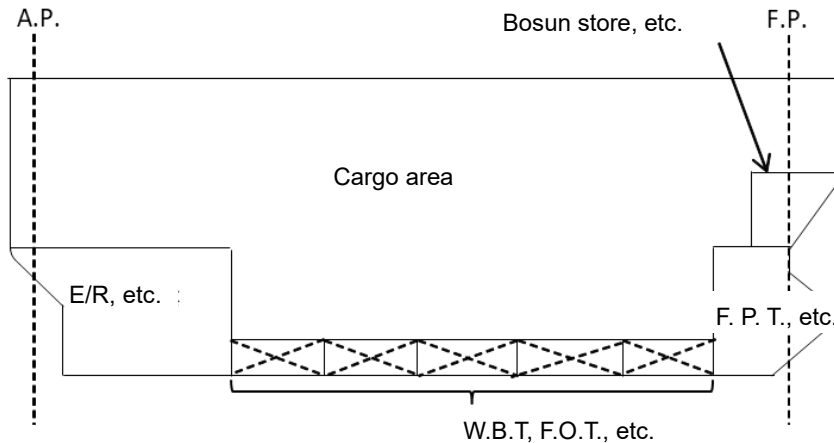

8.5.1.2 Members to be Assessed

1 The primary supporting members supporting racking deformation within the evaluation area are to satisfy the strength criteria specified in [8.5](#). Typical members to be assessed in each type of construction are to be in the following **(1)** and **(2)**.

- (1) Members to be assessed in type of construction where racking deformation is supported mainly by partial bulkheads and transverse bulkheads are to be as follows:
 - (a) Around opening of transverse bulkheads
 - (b) Partial bulkheads
 - (c) Pillars positioned in the same cross section as transverse bulkheads
- (2) Members to be assessed in type of construction where racking deformation is supported by transverse frames are as follows:
 - (a) Pillar
 - (b) Side frame
 - (c) For the ship with transverse bulkhead, the bulkhead

2 For type of construction that cannot be easily categorized into the type specified in -1 above, the members by which racking deformation is expected to be supported are to be selected appropriately taking into account the members for each type of construction specified in -1 above.

8.5.2 Boundary Conditions and Loads Conditions

8.5.2.1 Boundary Conditions

- 1 Translational and rotational displacements are to be appropriately restrained at both ends of the ship.
- 2 If there is a ramp way at the stern of the ship, the aft end of side shell is to be fixed.
- 3 Boundary conditions applied to a finite element model are shown in [Fig. 8.5.2-1](#).

Fig. 8.5.2-1 Example of Boundary Conditions

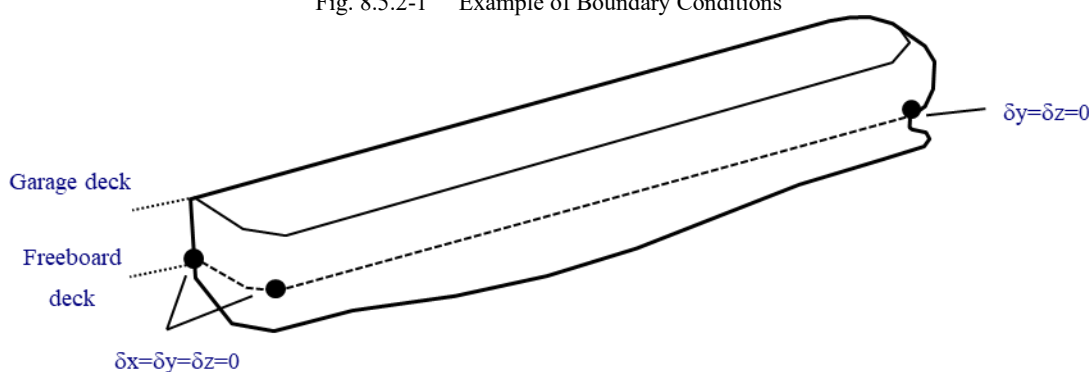

8.5.2.2 Loads Conditions

- 1 Loads specified in 4.5 are to be considered.
- 2 For external pressure, and internal pressure due to liquid, a constant pressure calculated at the element's centroid is to be applied to the shell element of the loaded surface (e.g. outer shell for external pressure and tank or cargo hold boundaries for internal pressure).
- 3 The weight of the cargo loaded onto the car deck is to be assumed to be evenly distributed across the deck and given as the distributed load for the car deck.
- 4 When cargo is loaded onto a movable deck, the weight of the movable car deck and the cargo weight shared across each panel are to be given as the nodal load at the movable deck support point.
- 5 When a movable deck is stored, the weight of the movable car deck is to be given as the nodal load to the panel storage point.

8.5.3 Yield Strength Assessment

8.5.3.1 Reference Stress

- 1 The equivalent stress σ_{eq} (N/mm^2) given by the following formula is to be used as the reference stress of shell elements for yield strength assessment. The stress at the element centroid of the mid-plane is to be used.

$$\sigma_{eq} = \sqrt{\sigma_1^2 - \sigma_1\sigma_2 + \sigma_2^2 + 3\tau_{12}^2}$$

σ_1 , σ_2 , τ_{12} : In-plane normal stresses of each element (N/mm^2), as given by the following formulae:

For XY plane elements, $\sigma_1 = 0$, $\sigma_2 = \sigma_y$, $\tau_{12} = 0$

For YZ plane elements, $\sigma_1 = \sigma_y$, $\sigma_2 = \sigma_z$, $\tau_{12} = \tau_{yz}$

For XZ plane elements, $\sigma_1 = 0$, $\sigma_2 = \sigma_z$, $\tau_{12} = 0$

XY plane, YZ plane, XZ plane: Based on the coordinate system specified in 1.4.3.6, Part 1.

σ_y , σ_z , τ_{yz} : Stresses of each element, with subscripts signifying the direction corresponding to the coordinate system specified in 1.4.3.6, Part 1.

- 2 For rod elements or beam elements, axial stress σ_a (N/mm^2) is to be used as the reference stress. The axial stress at the middle of the element length is to be used.

8.5.3.2 Strength Criteria

- 1 Members to be assessed within the evaluation are to satisfy the following formula:

$$\lambda_y \leq \lambda_{yperm}$$

λ_y : Yield utilisation factor, as given by the following formulae:

$$\text{For shell elements, } \lambda_y = \frac{\sigma_{eq}}{188/K}$$

$$\text{For rod elements, } \lambda_y = \frac{|\sigma_a|}{188/K}$$

λ_{yperm} : Permissible utilisation factor, be taken as 1.0

- 2 Notwithstanding -1 above, yield strength assessments of intersections of pillars and deck transverses are considered to be satisfied for the structural types specified in 8.5.1.2-1(2) or similar structural types when the following formula is satisfied:

$$t_{is-gr}\sigma_{Y-is} \geq 1.7 \cdot t_{dt-gr}\sigma_{Y-dt}$$

t_{is-gr} : Thickness (mm) (gross scantling) of intersections of pillars and deck transverses.

σ_{Y-is} : Specified minimum yield stress (N/mm^2) of intersections of pillars and deck transverses.

t_{dt-gr} : Smallest thickness (mm) (gross scantling) of the web of the deck transverses at the same height of the

intersection.

σ_{Y_dt} : Smallest specified minimum yield stress (N/mm^2) of the web of the deck transverses at the same height of the intersection.

3 Where members do not satisfy the criteria specified in -1 and -2 above, a detailed fatigue strength assessment are to be performed for the members and so as to ensure a sufficient fatigue lifetime.

Chapter 9 FATIGUE

9.1 General

9.1.1 Application of Fatigue Requirements

9.1.1.1 Application

Ships exclusively involved in the transport of cars, trucks, and other wheeled vehicles are to be assessed for fatigue strength based on the hot spot stresses obtained by simplified stress analysis according to **9.3, Part 1** and finite element analysis according to **9.4, Part 1**.

9.2 Structural Details to be Assessed

9.2.1 Structural Details to be Assessed by Finite Element Analysis

9.2.1.1

1 Critical structural details to be assessed for fatigue strength by finite element analysis according to **9.4, Part 1** are the primary supporting members supporting racking deformation.

2 Representative structural details in type of construction where racking deformation is supported mainly by partial bulkheads and transverse bulkheads are to be in accordance with **Table 9.2.1-1**.

3 Representative structural details in type of construction where racking deformation is supported by transverse frames are to be in accordance with **Table 9.2.1-2**.

4 For type of construction that cannot be easily categorized into the type specified in **-2** and **-3**, the members by which racking deformation is expected to be supported are to be selected appropriately.

5 The positions to be assessed for fatigue strength are to be selected appropriately based on the structural details specified in **-2** to **-4**. The positions to be assessed for fatigue strength are to be approved in advance by the Society.

6 Notwithstanding the requirements specified in **-5**, where documents demonstrating sufficient fatigue strength are submitted and deemed appropriate by the Society, the fatigue strength assessment of the structure may be omitted.

Table 9.2.1-1 Structural Details of Primary Members to be Assessed in Type of Construction Where Racking Deformation is Supported Mainly by Partial Bulkheads and Transverse Bulkheads

No.	Critical structural details of hull structure
1	Intersections of partial bulkhead web frame and car deck located in the same cross section of transverse bulkhead
2	Intersections of pillar and car deck located in the same cross section of transverse bulkhead
3	Opening corner of transverse bulkheads
4	Other areas with large stress concentration

Table 9.2.1-2 Structural Details of Primary Members to be Assessed in Type of Construction Where Racking Deformation is Supported by Transverse Frames Occurs in Transverse Frames

No.	Critical structural details
1	Intersections of pillar and car deck
2	Intersections of transverse frame and car deck
3	Other areas with large stress concentration

9.3 Loading Conditions and Fraction of Time to be Considered

9.3.1 General

9.3.1.1

- 1 Standard loading conditions and fraction of time are to be in accordance with [Table 9.3.1-1](#).
- 2 Notwithstanding the requirements specified in -1 above, when considering loading conditions and fraction of time other than those in [Table 9.3.1-1](#), it is necessary to consider appropriate combinations.

Table 9.3.1-1 Standard Loading Conditions and Fraction of Time

Loading conditions	Fraction of time $\alpha_{(j)}$
Full load condition (standard loading)	50 %
Ballast condition	50 %

9.4 Boundary Conditions and Load Conditions

9.4.1 Boundary Conditions

9.4.1.1

- 1 Translational and rotational displacements are to be appropriately restrained at both ends of the ship.
- 2 If there is a ramp way at the stern of the ship, the aft end of side shell is to be fixed.
- 3 Boundary conditions applied to a finite element model are shown in [Fig. 9.4.1-1](#).

Fig. 9.4.1-1 Example of Boundary Conditions

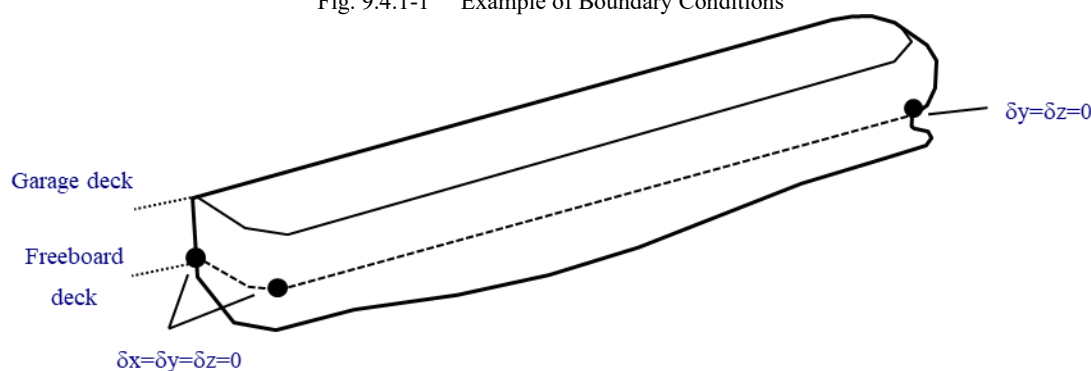

9.4.2 Load Conditions

9.4.2.1

- 1 Loads specified in [4.6](#) are to be considered.
- 2 For external pressure, and internal pressure due to liquid, a constant pressure calculated at the element's centroid is to be applied to the shell element of the loaded surface (e.g. outer shell for external pressure and tank or cargo hold boundaries for internal pressure).
- 3 The weight of the cargo loaded onto the car deck is to be assumed to be evenly distributed across the deck and given as the distributed load for the car deck.
- 4 When cargo is loaded onto a movable deck, the weight of the movable car deck and the cargo weight shared across each panel are to be given as the nodal load at the movable deck support point.
- 5 When a movable deck is stored, the weight of the movable car deck is to be given as the nodal load to the panel storage point.

2. 9.5 Screening Assessment

9.5.1 General

9.5.1.1 General

1 This 9.5 specifies a method for assessing the fatigue strength of structural details including those specified in 9.2 using coarse mesh models instead of the very fine mesh models specified in 9.4, Part 1.

2 When the fatigue damage calculated based upon the method specified in this 9.5 does not satisfy the criteria, fatigue strength assessment using a very fine mesh model is to be carried out.

3 The hot spot to be assessed, stress concentration factor derivation method, etc. is to be submitted beforehand to the Society for approval, when the fatigue strength is assessed according to the method specified in this 9.5.

9.5.1.2 Application

The method specified in this 9.5 is applied to general structural details to be assessed, as specified in Table 9.2.1-1 and Table 9.2.1-2.

9.5.1.3 Confirmation of Calculation Method and Accuracy of Analysis

1 The analysis method and analysis program are to have the following functions.

- (1) The effects of bending, shear, axial, and torsional deformation are to be effectively taken into consideration.
- (2) The behaviour of the 3-D structural model is to be represented effectively under reasonable boundary conditions.
- (3) The method and program are to be confirmed to have sufficient analytical accuracy.

2 The analysis method is to be approved in advance by the Society. The submission of details regarding the analysis method and verification of accuracy may be required when deemed necessary by the Society.

9.5.2 Finite Element Modelling

9.5.2.1 General

Coarse mesh models used in screening assessments are to be in accordance with 8.2.

9.5.2.2 Corrosion Models

Coarse mesh models used for screening assessments are to be made using tt_{n25} (mm). The corrosion addition to be considered is to be in accordance with the requirement in 3.3.4, Part 1.

9.5.3 Loading Conditions and Fractions of Time to be Considered

9.5.3.1 General

Loading conditions and fractions of time are to be in accordance with 9.3.1.

9.5.4 Boundary Conditions and Load Conditions

9.5.4.1 General

Boundary conditions and load conditions to be considered are to be in accordance with 9.4.

9.5.5 Hot Spot Stress

9.5.5.1 General

1 Hot spot stress may be obtained by using the stress acting on element midpoints of shell elements irrespective of the hot spot type used in the screening assessment.

2 The hot spot stress range and mean stress are to be obtained from the following formulae when conditions “i1” and “i2” for the same equivalent design wave for the same loading condition (j) are considered. The orthogonal direction to the weld line is represented by the x-direction and the parallel direction is represented by the y-direction.

$$\Delta\sigma_{HS_ort,i(j)} = K_{SCF} \cdot \Delta\sigma_{adj_x,i(j)}$$

$$\Delta\sigma_{HS_par,i(j)} = K_{SCF} \cdot \Delta\sigma_{adj_y,i(j)}$$

K_{SCF} : Stress concentration factor as given in -3 below.

$\Delta\sigma_{adj_x,i(j)}$: Stress range (N/mm^2) in the x-direction in the x-y coordinate system of the equivalent design wave “i” for loading condition (j) according to the following formula:

$$\Delta\sigma_{adj_x,i(j)} = |\sigma_{adj_x,i1(j)} - \sigma_{adj_x,i2(j)}|$$

$\sigma_{adj_x,i1(j)}$: Surface stress (N/mm^2) in the x-direction in the x-y coordinate system of the equivalent design wave “i1” for loading condition “j” on element midpoint of element in way of hot spot

$\sigma_{adj_x,i2(j)}$: Surface stress (N/mm^2) in the x-direction in the x-y coordinate system of the equivalent design wave “i2” for loading condition “j” on element midpoint of element in way of hot spot

$\Delta\sigma_{adj,y,i(j)}$: Stress range (N/mm^2) in the y -direction in the x - y coordinate system of the equivalent design wave “ i ” for loading condition “ j ” according to the following formula:

$$\Delta\sigma_{adj,y,i(j)} = |\sigma_{adj,y,i1(j)} - \sigma_{adj,y,i2(j)}|$$

$\sigma_{adj,y,i1(j)}$: Surface stress (N/mm^2) in the y -direction in the x - y coordinate system of the equivalent design wave “ $i1$ ” for loading condition “ j ” on element midpoint of element in way of hot spot

$\sigma_{adj,y,i2(j)}$: Surface stress (N/mm^2) in the y -direction in the x - y coordinate system of the equivalent design wave “ $i2$ ” for loading condition “ j ” on element midpoint of element in way of hot spot

$$\sigma_{mean_ort,i(j)} = K_{SCF} \cdot \frac{\sigma_{adj,x,i1(j)} + \sigma_{adj,x,i2(j)}}{2}$$

$$\sigma_{mean_par,i(j)} = K_{SCF} \cdot \frac{\sigma_{adj,y,i1(j)} + \sigma_{adj,y,i2(j)}}{2}$$

3 K_{SCF} for a representative hot spot of a representative transverse section is to be obtained by the following. The application method of an obtained K_{SCF} to other transverse sections is to be approved in advance by the Society.

- (1) Hot spot stress range for a representative hot spot of a representative transverse section is to be obtained by fatigue strength assessment using a very fine mesh model.
- (2) Nominal stress range is to be obtained in the same location as assessed in (1) above by finite element analysis using a coarse mesh model
- (3) K_{SCF} is to be obtained as the ratio of stress range obtained by (1) and (2) above.

9.5.6 Fatigue Strength Assessment

9.5.6.1 General

- 1 This 9.5.6 specifies requirements for the fatigue strength assessment method using the hot spot stresses obtained in 9.5.5.
- 2 The fatigue strength assessment in this 9.5 is based on Miner’s linear cumulative damage rule.
- 3 Total cumulative fatigue damage is to be calculated for all loading conditions by using each fatigue damage in the in-air environment where the coating is effective and in the corrosive environment where the coating is not effective, considering the ratio of period of each environment.

9.5.6.2 Reference Stress for Fatigue Strength Assessment

Hot spot stress ranges used in screening assessments, $\Delta\sigma_{FS,(j)}$, are $\Delta\sigma_{FS_ort,(j)}$ and $\Delta\sigma_{FS_par,(j)}$, and fatigue damage is to be calculated for each stress range.

where,

$$\Delta\sigma_{FS_ort,(j)} = \max_i(\Delta\sigma_{FS_ort,i(j)})$$

$$\Delta\sigma_{FS_par,(j)} = \max_i(\Delta\sigma_{FS_par,i(j)})$$

$\Delta\sigma_{FS_ort,i(j)}$: Hot spot stress range (N/mm^2) for screening assessment according to the hot spot stress in the direction orthogonal to the weld line, as obtained from the following formula:

$$\Delta\sigma_{FS_ort,i(j)} = f_{mean_ort,i(j)} \cdot \Delta\sigma_{HS_ort,i(j)}$$

$\Delta\sigma_{FS_par,i(j)}$: Hot spot stress range (N/mm^2) for screening assessment according to the hot spot stress in the direction parallel to the weld line, as obtained from the following formula:

$$\Delta\sigma_{FS_par,i(j)} = 0.72 \cdot f_{mean_par,i(j)} \cdot \Delta\sigma_{HS_par,i(j)}$$

f_R : Correction factor corresponding to the wave environment in accordance with 9.5.2.1, Part 1

$f_{mean_ort,i(j)}$, $f_{mean_par,i(j)}$: Correction factor for mean stress effect, as obtained by the following formulas for each combination of $\Delta\sigma_{HS_ort,i(j)}$, $\sigma_{mean_ort,i(j)}$ and $\Delta\sigma_{HS_par,i(j)}$, $\sigma_{mean_par,i(j)}$ respectively.

$$\begin{cases} f_{mean,i(j)} = \min \left[1.0, 0.8 + 0.2 \frac{\sigma_{mCor,i(j)}}{2\Delta\sigma_{HS,i(j)}} \right] : \sigma_{mCor,i(j)} \geq 0 \\ f_{mean,i(j)} = \max \left[0.6, 0.8 + 0.2 \frac{\sigma_{mCor,i(j)}}{2\Delta\sigma_{HS,i(j)}} \right] : \sigma_{mCor,i(j)} < 0 \end{cases}$$

Where, $\sigma_{mCor,i(j)}$ is to be obtained as follows:

$$\begin{cases} \sigma_{mCor,i(j)} = \sigma_{mean,i(j)} & : \sigma_{max} \leq \sigma_{YEq} \\ \sigma_{mCor,i(j)} = \sigma_{YEq} - \sigma_{max} + \sigma_{mean,i(j)} & : \sigma_{max} > \sigma_{YEq} \end{cases}$$

$$\sigma_{max} = \max_i(\Delta\sigma_{HS,i(j)} + \sigma_{mean,i(j)})$$

$$\sigma_{YEq} = \max(315, \sigma_Y)$$

$\Delta\sigma_{HS_ort,i(j)}$, $\Delta\sigma_{HS_par,i(j)}$: As given in **9.5.5.1-2**.

$\sigma_{mean_ort,i(j)}$, $\sigma_{mean_par,i(j)}$: As given in **9.5.5.1-2**.

9.5.6.3 Fatigue Damage Calculation and Fatigue Strength Assessment Criterion

1 The cumulative fatigue damage D is to be obtained from the following formula:

$$D = \sum_j \alpha_{(j)} \cdot D_{(j)}$$

$\alpha_{(j)}$: Fraction of time of loading condition (j) in the fatigue design life, as given in **Table 9.3.1-1**.

$D_{(j)}$: Cumulative fatigue damage for the fatigue design life for loading condition (j) calculated by the following formula:

$$D_{(j)} = \frac{T_{FD} - T_C}{T_{FD}} D_{air,(j)} + \frac{T_C}{T_{FD}} D_{cor,(j)}$$

$D_{air,(j)}$, $D_{cor,(j)}$: Cumulative fatigue damage in the in-air environment and corrosive environment for the fatigue design life for loading condition (j).

$$D_{air,(j)} = \frac{N_{FD}}{K_{2,air}} \frac{\Delta\sigma_{FS,(j)}^m}{(\ln N_R)^{m/\xi}} \cdot \mu_{(j)} \cdot \Gamma\left(1 + \frac{m}{\xi}\right)$$

$$D_{cor,(j)} = \frac{N_{FD}}{K_{2,cor}} \frac{\Delta\sigma_{FS,(j)}^m}{(\ln N_R)^{m/\xi}} \cdot \Gamma\left(1 + \frac{m}{\xi}\right)$$

N_{FD} : Total number of cycles in the fatigue design life T_{FD} .

$$N_{FD} = \frac{60 \times 60 \times 24 \times 365.25}{4 \log L_c} \cdot f_D \cdot T_{FD}$$

f_D : Ship's operation rate, taken as 0.85

$\Delta\sigma_{FS,(j)}$: Fatigue stress range (N/mm^2) at the reference probability level of exceedance of 10^{-2}

m : Inverse of the slope of the $S-N$ curve, taken as $m = 3$

N_R : Number of cycles corresponding to the reference probability of exceedance of 10^{-2} , taken as $N_R = 100$

ξ : Weibull shape parameter, taken as $\xi = 1$

$\Gamma(x)$: Complete Gamma function

$K_{2,air}$: Constant of the design $S-N$ curve for in-air environment, taken as 1.52×10^{12}

$K_{2,cor}$: Constant of the design $S-N$ curve for corrosive environment, taken as 7.60×10^{11}

$\mu_{(j)}$: Coefficient taking into account the change of inverse slope of the $S-N$ curve, m ,

· For in-air environment

$$\mu_{(j)} = 1 - \frac{\left\{ \gamma\left(1 + \frac{m}{\xi}, v_{(j)}\right) - v_{(j)}^{-\Delta m/\xi} \cdot \gamma\left(1 + \left(\frac{m + \Delta m}{\xi}\right), v_{(j)}\right) \right\}}{\Gamma\left(1 + \frac{m}{\xi}\right)}$$

$$v_{(j)} = \left(\frac{\Delta\sigma_q}{\Delta\sigma_{FS,(j)}} \right)^\xi \ln N_R$$

· For corrosive environment

$$\mu_{(j)} = 1$$

$\gamma(a, x)$: Incomplete Gamma function

Δm : Change in inverse slope of $S-N$ curve at $N = 10^7$ cycles, taken as $\Delta m = 2$.

$\Delta\sigma_q$: Stress range (N/mm^2) corresponding to the intersection of the two segments of design $S-N$ curve at $N = 10^7$ cycles, taken as $\Delta\sigma_q = 53.4$

2 Fatigue strength assessment criterion is to be in accordance with **9.5.5, Part 1**.

3 Correction factor for post-weld treatment by grinding is not to be considered.

Chapter 10 ADDITIONAL STRUCTURAL REQUIREMENTS

10.1 Car Deck

10.1.1 Plates and Beams

10.1.1.1 General

1 Plates and stiffeners on car decks are to be accessed according to the conditions described in (1) and (2) below.

(1) Maximum load condition

(2) Harbour condition (for forklifts and other vehicles only used for cargo handling in harbours)

2 The concentrated load from vehicles is to be taken into consideration for decks loaded with wheeled vehicles and stiffeners installed on decks.

10.1.1.2 Section Modulus of Stiffeners

1 The section modulus of stiffeners of decks loaded with wheeled vehicles (hereinafter referred to as “car decks”) is not to be less than that obtained from the following formula. However, Where the span length or moment of inertia changes along the continuous stiffener, the scantlings of the stiffener are to be determined by direct strength calculation as specified in -2.

$$C_{load} C_1 \frac{M}{C_S \sigma_Y} \times 10^3 \quad (cm^3)$$

C_{load} : The safety factor in relation to dynamical influence caused by ship motion, which is 1.0 under maximum load conditions, and 1.2 under harbour conditions (vehicles used for cargo handling only).

C_1 : Coefficient determined as follows:

1.0 for $b/S \leq 0.8$

$1.25 - 0.31b/S$ for $b/S > 0.8$

S : Stiffener spacing (m)

b : Length (m) of wheel print measured at right angle to stiffeners (See Fig. 10.1.1-1) For vehicles with ordinary pneumatic tires, values in Table 10.1.1-1 may be used.

C_S : Coefficient related to the influence of axial force, according to Table 10.1.1-2.

σ_Y : Standard yield stress (N/mm^2)

M : M_1 , M_2 and M_{3j} obtained from the following formula, whichever is the greatest ($kN-m$)

$$M_1 = \frac{1}{15} \left\{ \sum_{i=1}^{N_I} 4P_{Ii} \alpha_{Ii} \left[1 - \left(\frac{\alpha_{Ii}}{\ell} \right)^2 \right] + \sum_{j=1}^{N_{II}} P_{IIj} \alpha_{IIj} \left(1 - \frac{\alpha_{IIj}}{\ell} \right) \left(7 - 5 \frac{\alpha_{IIj}}{\ell} \right) - \sum_{k=1}^{N_{III}} P_{IIIk} (\ell - \alpha_{IIIk}) \left[1 - \left(\frac{\ell - \alpha_{IIIk}}{\ell} \right)^2 \right] \right\}$$

$$M_2 = \frac{1}{15} \left\{ - \sum_{i=1}^{N_I} P_{Ii} \alpha_{Ii} \left[1 - \left(\frac{\alpha_{Ii}}{\ell} \right)^2 \right] + \sum_{j=1}^{N_{II}} P_{IIj} \alpha_{IIj} \left(1 - \frac{\alpha_{IIj}}{\ell} \right) \left(2 + 5 \frac{\alpha_{IIj}}{\ell} \right) + \sum_{k=1}^{N_{III}} 4P_{IIIk} (\ell - \alpha_{IIIk}) \left[1 - \left(\frac{\ell - \alpha_{IIIk}}{\ell} \right)^2 \right] \right\}$$

$$M_{3j} = \left| R_{II} \alpha_{IIj} - \sum_{r=0}^{j-1} P_{IIr} (\alpha_{IIj} - \alpha_{IIr}) - \left(\frac{M_2 - M_1}{\ell} \right) \alpha_{IIj} - M_1 \right|$$

Where: $P_{II0} = 0$, $\alpha_{II0} = 0$

ℓ : Span (m) of stiffener between support points

P_{Ii} , P_{IIj} , P_{IIIk} : The wheel load at each support point, as specified in 4.7.2.1 and 4.7.3.1. Subscript “ Ii ” means the i th load point from left end of the I th stiffener (See Fig. 10.1.1-2). Subscript “ IIj (or IIr)” means the j th (or r th) load point from left end of the II th stiffener (See Fig. 10.1.1-2). Subscript “ $IIIk$ ” means the k th load point from left end of the III th stiffener (See Fig. 10.1.1-

2)

$\alpha_{Ii}, \alpha_{IIj}, \alpha_{IIIk}$: Distance (m) from each support point to the point of action of wheel load (See Fig. 10.1.1-2), when wheels are so arranged that M may be at its maximum value.

N_I, N_{II}, N_{III} : Number of wheel loads between each span

R_{II} : The value obtained from following the formula

$$R_{II} = \frac{1}{\ell} \sum_{j=1}^{N_{II}} P_{IIj} (\ell - \alpha_{IIj})$$

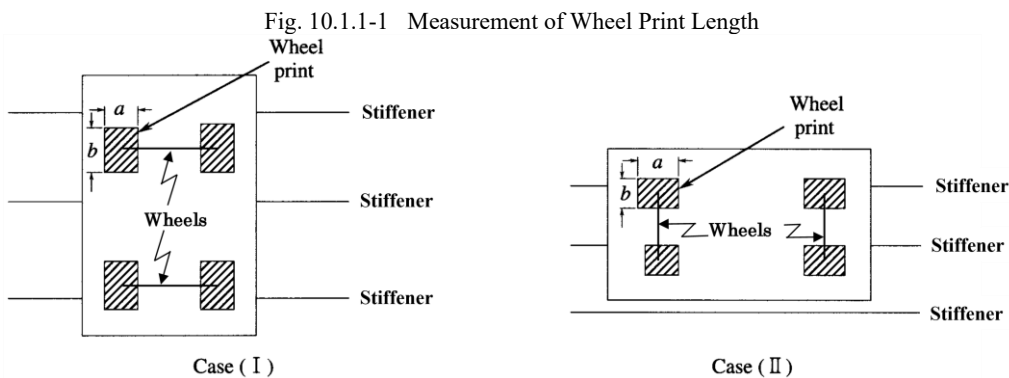

Fig. 10.1.1-2 Measurement of $P_{Ii}, \alpha_{Ii}, \ell$ etc.

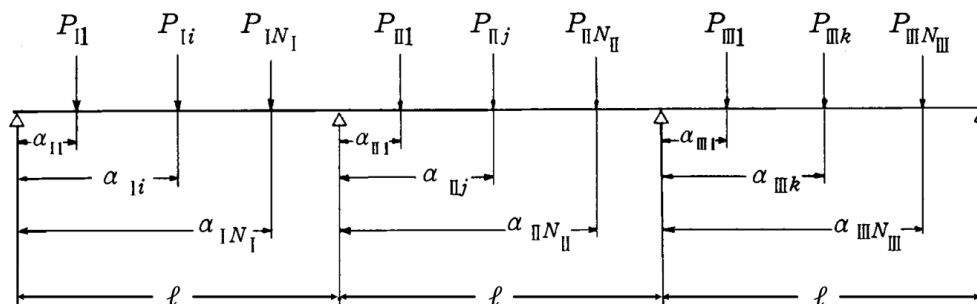

Table 10.1.1-1 Wheel Print Length (m) (Pneumatic Tires)

	Wheel print length parallel to axle in Fig. 10.1.1-1, a in Case (I), b in Case (II)	Wheel print length right angles to axle in Fig. 10.1.1-1, b in Case (I), a in Case (II)
Single tire	Tire width	$\frac{1}{20} \sqrt{P}$
Double tire	2×Tire width. Gap between tires, if any, may be added.	$\frac{9}{250} \sqrt{P}$

Notes:

P : Maximum design wheel load (kN). Where the maximum design wheel load is given in *tons*, the value of P is to be multiplied by 9.81 to convert it into (kN).

Table 10.1.1-2 Value of C_s

	C_s
Longitudinals of strength decks	$1.0 - \frac{ \sigma_{BM} }{\sigma_Y}$
Other than those above	1.0

Notes:

σ_{BM} : According to **6.2.3, Part 1** under maximum weight conditions.

According to the following formula under harbour conditions.

$$\sigma_{BM} = \left| \frac{M_{PT}}{I_{Vertical}} (z - z_B) \right| \times 10^5$$

M_{PT} : The vertical bending moment in the harbour, according to **4.3.1.1, Part 1**.

$I_{Vertical}$: The moment of inertia around the horizontal neutral axis of the transection of the member under consideration (net scantling approach) (cm^4)

z : Z coordinate at the load calculation point of the member under consideration (m)

z_B : Z coordinate of the horizontal neutral axis of the transection under consideration (m)

Further, the coordinate system and load calculation point are to be as prescribed in **1.4.3.5, Part 1** and **3.7.1.3, Part 1**, respectively.

2 Scantlings of stiffeners of car decks may be determined by the direct calculation methods shown below.

- (1) The model of structures and the method of calculation are to be those approved by the Society.
- (2) Loads are in accordance to **4.7.2.1** and **4.7.3.1**.
- (3) The allowable stresses for calculation of the section modulus are to be as shown in **Table 10.1.1-3**.

 Table 10.1.1-3 Allowable Stress (N/mm^2)

Members	Maximum load condition	Harbour condition (vehicles used for cargo handling only)
Longitudinals of strength decks	$C_s \sigma_Y$	$\frac{1}{1.2} C_s \sigma_Y$
Other than those above	σ_Y	$\frac{1}{1.2} \sigma_Y$

Notes:

C_s : Coefficient related to the influence of axial force, according to **Table 10.1.1-2**.

σ_Y : Standard yield stress (N/mm^2)

10.1.1.3 Thickness of Car Deck

The thickness of car deck is to be in accordance with (1) or (2) below.

- (1) Where the distance between the centres of wheel prints in a panel is not less than $2S + a$:

$$C \sqrt{\frac{2S - b'}{2S + a}} \cdot P \times 10^3 \quad (\text{mm})$$

S : Stiffener spacing (m)

P : The wheel load at each support point, as specified in **4.7.2.1** and **4.7.3.1**. However, when $b > S$, the value is to be multiplied by S/b .

b' : b or S , whichever is the smaller (m)

b : Length (m) of wheel print measured at right angle to stiffeners. (See **Fig. 10.1.1-1**)

a : Length (m) of wheel print measured in parallel with stiffeners. (See **Fig. 10.1.1-1**)

However, for vehicles with ordinary pneumatic tires, values of a and b in **Table 10.1.1-1** may be used.

C : Coefficient determined as follows.

$$C = \frac{1}{2} \sqrt{\frac{C_{coll} C_{load}}{C_a \sigma_Y}}$$

C_{coll} : The safety factor in relation to the plastic collapse load of the plate, which is 1.7

C_{load} : The safety factor in relation to dynamical influence caused by ship motion, which is 1.0 under maximum load conditions, and 1.2 under harbour conditions (vehicles used for cargo handling only).

C_a : Axial force influence coefficient, according to [Table 10.1.1-4](#).

(2) Where the distance between centres of wheel prints in a panel is less than $2S + a$ ([Fig. 10.1.1-3](#)):

$$C \sqrt{\frac{2S - b'}{2S + a + e}} \cdot nP \times 10^3 (mm)$$

Where: C , S , a , b' and P : As prescribed in (1) above.

e : Sum of distances (m) between centres of wheel prints where wheels are placed side by side at a spacing of less than $2S + a$ in one panel. (See [Fig. 10.1.1-3](#))

n : Number of wheel loads in the range of e

Table 10.1.1-4 Value of C_a

Members		C_a
Strength deck	Longitudinal framing system	$\sqrt{1 - \left(\frac{\sigma_{BM}}{\sigma_Y}\right)^2}$
	Transverse framing system	$1.0 - \frac{ \sigma_{BM} }{\sigma_Y}$
Other than those above		1.0

Notes:

σ_{BM} : As specified in the note of [Table 10.1.1-2](#).

σ_Y : Standard yield stress (N/mm^2)

Fig. 10.1.1-3 Method for Measuring e

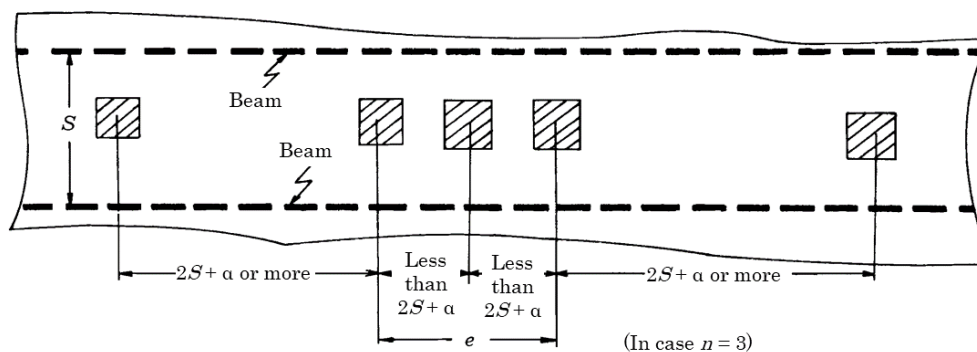

10.1.1.4 Car Deck Girders

The scantlings of deck girders of car decks and girders of similar thin plate construction are to be determined in accordance with the method which is to be as deemed appropriate by the Society.

10.2 Movable Car Deck

10.2.1 Movable Car Deck Girders

10.2.1.1 General

Deck girders of movable car decks and girders of similar thin plate construction are to be in accordance with the requirements of [10.2](#).

10.2.1.2 Strength Requirement*

- 1 The scantlings of movable car deck girders are to be determined in accordance with the following requirements in -2 to -4.
- 2 The effective breadth of compressive plate flange for each girder is to be determined by the following (1) and (2) corresponding to the stiffening direction of the panel.

- (1) Effective breadth for girders parallel to the stiffening direction:

The value specified in **3.6.3, Part 1**.

- (2) Effective breadth (b_{eft}) for girders crossing at right angles with the stiffening direction:

$$b_{eft} = \sum_n \left(\frac{C_{et} \cdot a}{2} \right) (mm)$$

Where buckling stiffeners for deck plates are fitted properly, these may be taken into account for the determination of effective breadth. However, it is not to exceed the value specified in **3.6.3, Part 1**.

C_{et} : Coefficient as given by the following formula However, where it exceeds 1.0, it is to be taken as 1.0.

$$C_{et} = \left(\frac{3}{\beta} - \frac{1.75}{\beta^2} \right) \frac{b}{a} + \left(\frac{0.075}{\beta} + \frac{0.75}{\beta^2} \right) \left(1 - \frac{b}{a} \right)$$

n : 1 for girders located on the periphery of the car deck, and 2 for the others

a : Spacing (mm) of girders crossing at right angles with the stiffening direction

b : Spacing (mm) of stiffeners

β : Coefficient determined as follows.

$$\beta = \frac{b}{t} \sqrt{\frac{\sigma_F}{E}}$$

t : Thickness (mm) of car deck plating

σ_F : Minimum upper yield stress or proof stress (N/mm^2) of the car deck material

E : Modulus of elasticity (N/mm^2) of the material to be assumed equal to 2.06×10^5 for steel

- 3 Design load and allowable stresses are to be in accordance with the requirements of the following (1) and (2).

- (1) Design load P (kN/m^2)

As specified in **4.7.2.1-2** and **4.7.3.1-2**.

- (2) Allowable stresses (N/mm^2)

As specified in **Table 10.2.1-1**.

Table 10.2.1-1 Allowable Stresses

	Maximum load condition	Harbour condition (vehicles used for cargo handling only)
Normal Stresses	σ_F	$0.83\sigma_F$
Shear Stresses	$0.58\sigma_F$	$0.48\sigma_F$

Notes:

σ_F : Minimum upper yield stress or proof stress (N/mm^2) of the material

- 4 Where the scantlings of girders are determined based upon direct calculations, the method of assessments are to be a grillage model analysis or that as deemed appropriate by the Society. "The method of assessment ... as deemed appropriate by the Society" mentioned above means an assessment method that can take into account the elastic buckling effects of compression panels of the car deck. Otherwise, a linear FE analysis using the shell elements and a buckling strength check of compression panels in accordance with the requirements of **Annex 8.6, Part 1 "Buckling Strength Assessment Based on Cargo Hold Analysis"** may be conducted.

10.2.1.3 Structural Details

The thickness of web plates is not to be less than that obtained by the following formula, except where an analysis of the buckling strength of the web plate has been conducted.

$$\frac{d}{C} (mm)$$

d : Depth of girders (mm)

C : Coefficient as given by the following:

65 for symmetrically flanged girders

55 for asymmetrically flanged girders

10.2.2 Support Structures of Movable Car Deck

10.2.2.1

- 1 The requirements in 10.2.2 apply to structures supporting movable car deck.
- 2 Support structures of movable car deck are to be arranged appropriately considering factors such as the shape and the design load.
- 3 The connections of supporting members to hull structural members are to be suitably constructed so as to avoid stress concentration. If necessary, suitable reinforcement is to be provided by means of stiffeners, brackets, etc.
- 4 Where deck panels are suspended by wire ropes, the ropes are to comply with the requirements of Part L or the requirements of the standards as deemed appropriate by the Society, and be subjected to suitable corrosion prevention treatment. The safety factor of the wire ropes is not to be less than the value specified in Table 10.2.2-1.
- 5 Gross scantlings of supporting structural members are to be determined to withstand the design loads defined in 10.2.1.2-3 (1), using the allowable stresses (N/mm^2) shown in Table 10.2.2-2.

Table 10.2.2-1 Safety Factor of Stresses in Wire Rope

Maximum load condition	Harbour condition (vehicles used for cargo handling only)
$\frac{10^4}{8.85W + 1910}$ However, it may not exceed 4.	$1.2 \frac{10^4}{8.85W + 1910}$ However, it may not exceed 4.8.

Notes:

W : Safe working load (ton)

- 5 Gross scantlings of supporting structural members are to be determined to withstand the design loads defined in 10.2.1.2-3 (1), using the allowable stresses (N/mm^2) shown in Table 10.2.2-2.

Table 10.2.2-2 Allowable Stresses

	Maximum load condition	Harbour condition (vehicles used for cargo handling only)
Bending stress σ	$0.50\sigma_F$	$0.42\sigma_F$
Shear stress τ	$0.34\sigma_F$	$0.28\sigma_F$
Equivalent stress σ_e	$0.64\sigma_F$	$0.53\sigma_F$

Notes:

Equivalent stress: $\sigma_e = \sqrt{\sigma^2 + 3\tau^2} (N/mm^2)$

σ_F : Minimum upper yield stress or proof stress (N/mm^2) of the material

Chapter 12 WELDING

12.1 Additional Requirements for Joints at Specific Locations

12.1.1 Car Deck

12.1.1.1 Stiffeners of Car Decks

1 The impact of the dynamic load caused by vehicular traffic is to be taken into account when determining the kind of stiffeners used and the fillet welding method for connecting those stiffeners to the car deck.

2 The method used to weld the stiffeners to the car deck is to be at least in accordance with the requirements specified in [Table 12.1.1-1](#) according to the type of stiffener and frequency of vehicular traffic.

3 Notwithstanding -2 above, the requirement stipulated in [12.2.1.3-4, Part 1](#) of the Rules applies. Where continuous welding is carried out only on one side, at least *F2* welding is to be carried out on the other side, as specified below.

- (1) Up to 0.1ℓ from the end of the stiffeners
- (2) 0.1ℓ on either side of the intersection of stiffeners and girders

Table 12.1.1-1 Method of Fillet Weld ^{(*)4}

	Deck panels on which vehicular traffic is frequent ^{(*)1}	Panels other than those specified in the left column
General type	<i>F2</i> (Both sides or One side)	<i>F4</i> or <i>F2</i> (One side)
Channel type ^{(*)2}	<i>F2</i> (Both sides)	<i>F4</i>
Channel type ^{(*)3}	<i>F2</i> (Web side of flange)	<i>F4</i> (Web side of flange)

^{(*)1}: Deck panels which are subject to the dynamic load in the vicinity of the ramp way and is on the route taken by vehicles when moving between decks

^{(*)2}: Channel type beams as shown in [Fig. 12.1.1-1](#), which are joined to the deck with spot-welds or intermittent welds

^{(*)3}: Channel type beams as shown in [Fig. 12.1.1-2](#), which are joined to the deck with a full penetration weld.

^{(*)4}: “*F2*” and “*F4*” in this table and is as specified in [Table 12.2.1-1, Chapter 12, Part 1](#).

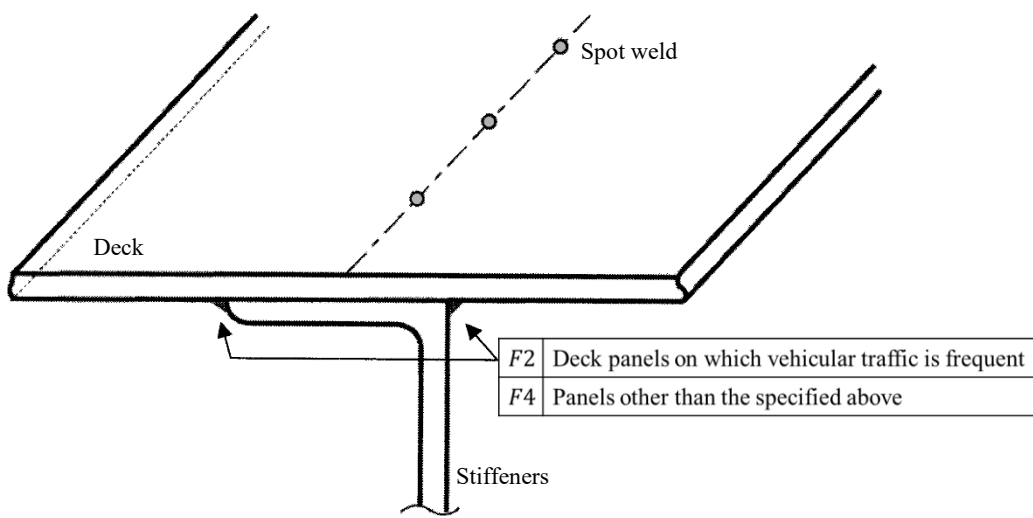
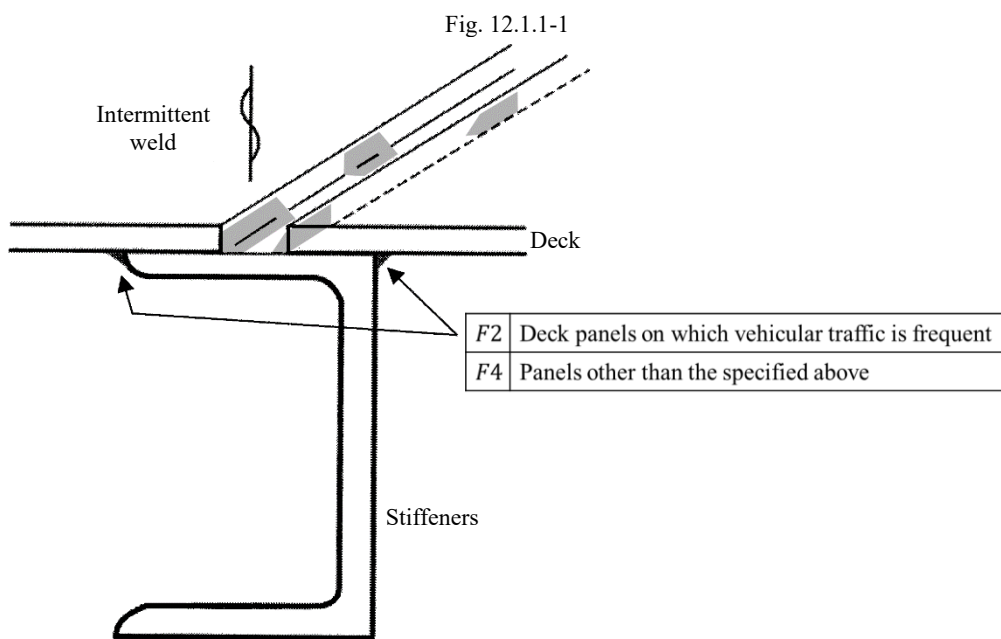
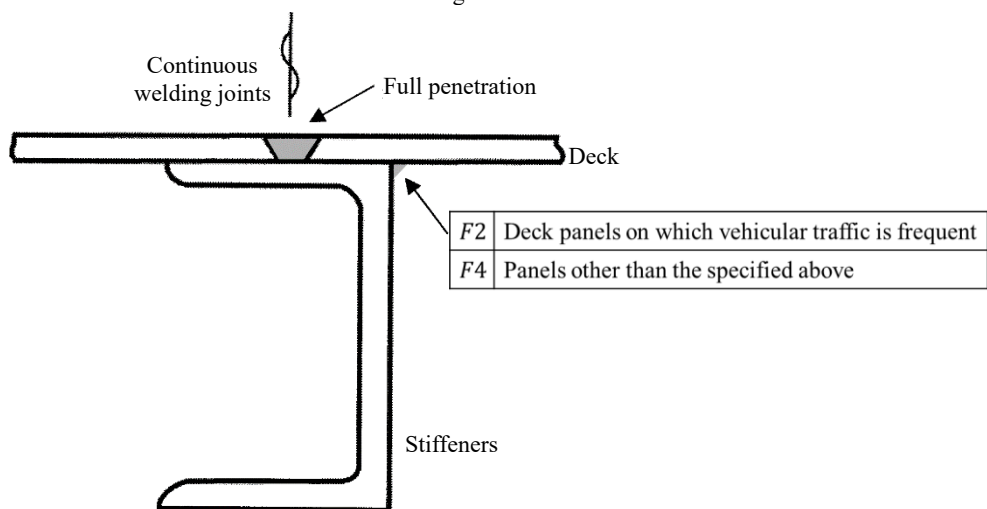

Fig. 12.1.1-2



12.1.1.2 Girders of Movable Car Decks

The connection of girder webs to the car deck is to use the fillet welding method in accordance with [Table 12.1.1-2](#).

Table 12.1.1-2 Fillet Weld of Girder to Movable Car Deck ^{(*)4}

	Panels on which vehicular traffic is frequent ^{(*)1}	Panels other than those specified in the left column
(1) Girders on the deck panel periphery	<i>F2</i> (Both sides)	<i>F2</i> (Both sides)
(2) Within 0.3ℓ midspan of girders other than mentioned in (1) ^{(*)2}		
(2) Within 0.1ℓ of end parts of girders other than mentioned in (1) ^{(*)2}		
(4) Within $0.2\ell'$ of intersections of girders other than mentioned in (1) ^{(*)3}		
(5) Other than those above		<i>F2</i> (One side), at least

^{(*)1}: Deck panels which are subject to the dynamic load in the vicinity of the ramp way and is on the route taken by vehicles when moving between decks

^{(*)2}: ℓ' is the total length of each girder

^{(*)3}: ℓ' is the span of each girder, and $0.1\ell'$ on either side of the intersection of girders is to be welded

^{(*)4}: “*F2*” in this table is as specified in [Table 12.2.1-1, Chapter 12, Part 1](#)

Part 2-7 TANKERS

Chapter 1 GENERAL

1.1 General

1.1.1 Application

1.1.1.1 Application of This Part

- 1 The hull construction and equipment of the following ships are to be in accordance with the requirements in [Part 2-7](#) in addition to [Part 1](#).
 - (1) Ships intended to be registered as tankers affixed with the notation “*Tanker*” (abbreviated as *T*)
 - (2) Ships intended to be registered as ships carrying dangerous chemicals in bulk affixed with the notation “*Chemical Tanker*” (abbreviated as *CT*)
 - (3) Ships carrying liquid cargoes in independent tanks, excluding ships carrying dangerous chemicals in bulk and ships carrying liquefied gases in bulk, , affixed with the notation “*Tank Carrier*” (abbreviated as *TC*)
- 2 The requirements in [Part 2-7](#) are for ships described in the following (1) and (2).
 - (1) Ships carrying liquid cargoes in tanks integrated with their hull structures as well as having one or more longitudinal bulkheads and single decks with double bottoms and double side hull structures
 - (2) Ships with single decks and self-supporting tanks that do not form part of the hull structure
- 3 Ships with a different construction from that specified in -2 above, to which the requirements in this Part are considered to be not applicable, are to be at the discretion of the Society.
- 4 Depending on ship size, navigating area and cargoes carried, the relevant requirements of [Chapter 14](#), [Part D](#), [Chapter 4](#), [Part H](#), [Part R](#), [Part S](#) as well as the [Rules for Marine Pollution Prevention Systems](#) are to also be applied.

1.2 Definitions

1.2.1 Naming Convention

1.2.1.1 Structural Nomenclature

[Fig. 1.2.1-1](#) and [Fig. 1.2.1-2](#) show the common structural nomenclature used in [Part 2-7](#).

Fig. 1.2.1-1 Tankers

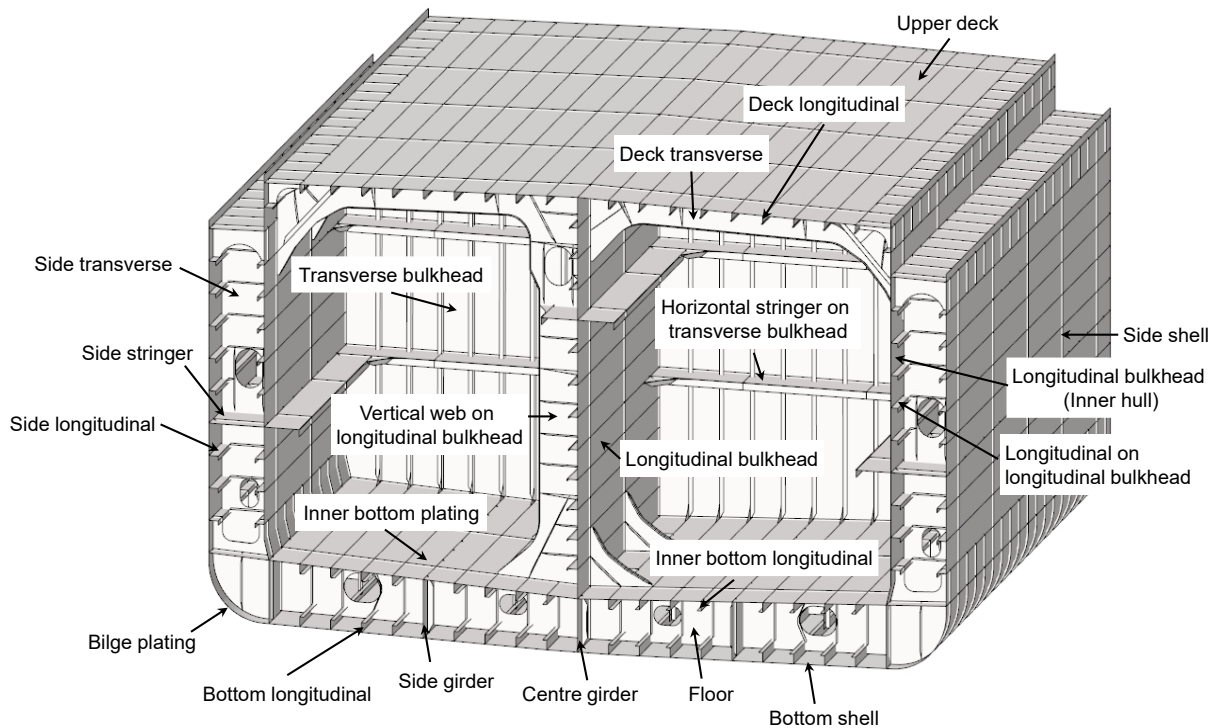
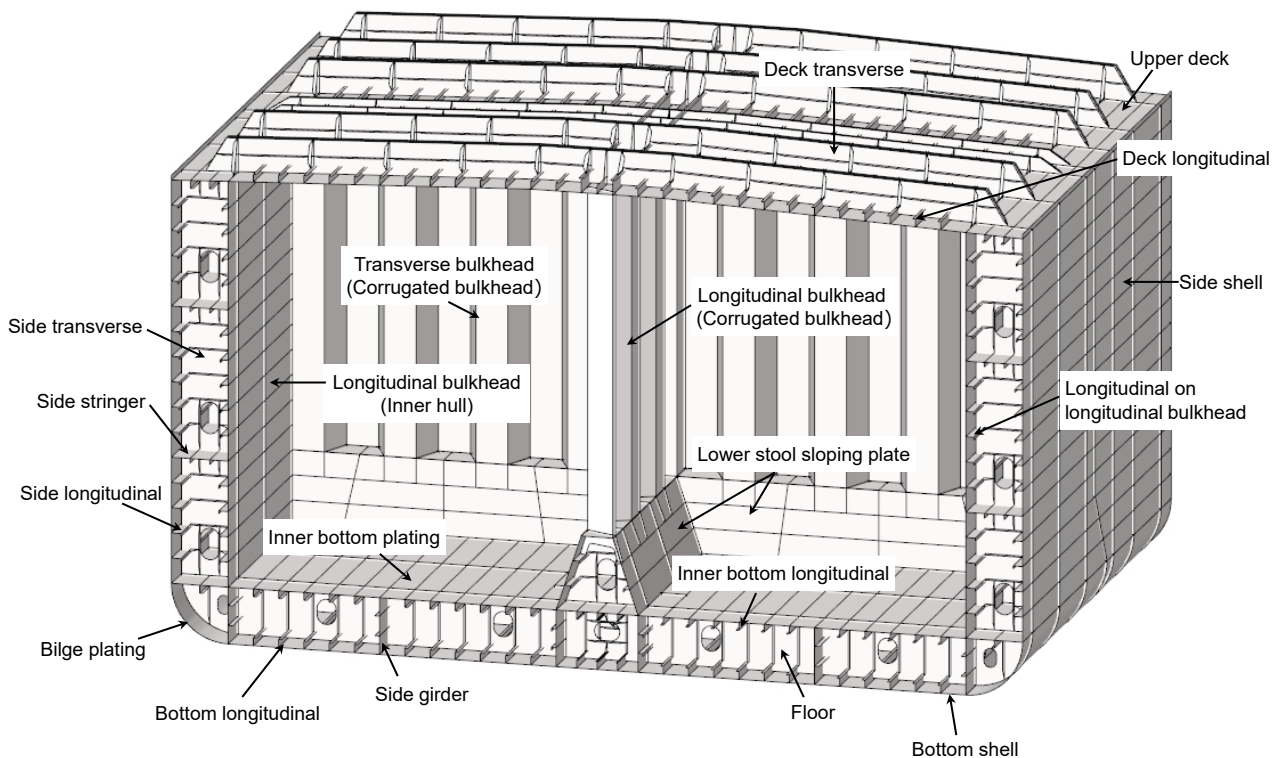

Fig. 1.2.1-2 Chemical Tankers



Chapter 2 GENERAL ARRANGEMENT DESIGN

2.1 Structural Arrangements

2.1.1 Arrangement and Separation

2.1.1.1 Separation of Cargo Oil Tanks, etc.

1 Cofferdams are to be provided in accordance with the following (1) to (6):

- (1) Cofferdams of air-tight construction with a sufficient width for access are to be provided at fore and aft terminations of cargo oil spaces and at spaces between cargo spaces and accommodation spaces. However, for oil tankers intended to carry cargo oil having a flash point above 60 °C, the preceding requirements may be suitably modified.
- (2) Cofferdams specified in (1) may be used as pump rooms.
- (3) Fuel oil or ballast water tanks may be concurrently used as the cofferdams to be provided around cargo oil tanks subject to approval by the Society.
- (4) Where a cargo oil tank is adjacent to the fore peak (fore peak tank), the collision bulkhead is to be free from openings. (See 14.3.2 and 14.3.3, Part D)
- (5) Divisions between compartments defined as cofferdams and other compartments (except cargo oil tanks and fuel oil tanks) are not to have any openings with the exception of bolted watertight manholes provided in chain locker bulkheads, etc. (no watertight door is permitted).
- (6) Electrical equipment is to be dealt with referring to the relevant requirements in Chapter 4, Part H.

2 When separating bulkheads with a cofferdam, the standard layout is such that the distance between bulkheads is at least 600 mm.

2.1.1.2 Airtight Bulkheads

1 All areas where there are cargo oil pumps and cargo oil piping are to be segregated by an air-tight bulkhead from areas where stoves, boilers, propelling machinery, electric installations other than those of explosion-proof type in accordance with 4.2.4, Part H or machinery with a source of ignition is normally present. However, for oil tankers carrying cargo oil having a flash point above 60 °C, the requirements may be suitably modified.

2 Cofferdams which are not utilized as main or auxiliary pump rooms and compartments utilized as cofferdams under the freeboard deck are to meet the requirements for the strength of deep tanks. The bulkhead between the main pump room and engine room is to have structural scantlings of a watertight bulkhead in ships of not less than 100 m in length L_C and of an airtight bulkhead in ships of less than 100 m in length L_C .

2.1.1.3 Openings

1 Ventilation inlets and outlets are to be arranged so as to minimize the possibilities of vapours of cargoes being admitted to an enclosed space containing a source of ignition or collecting in the vicinity of deck machinery and equipment which may constitute an ignition hazard. Especially, ventilation openings for machinery spaces are to be situated as far afterwards as practicable from cargo spaces.

2 Ullage openings, sighting ports and tank cleaning openings are not to be arranged in enclosed spaces.

2.1.1.4 Superstructures and Deckhouses

1 The arrangement of openings on the boundaries of superstructures and deckhouses are to be such as to minimize the possibility of accumulation of vapours of cargoes. Due consideration in this regard is to be given to the openings in superstructures and deckhouses when the ship is equipped with cargo piping to load or unload at the stern.

2 The deckhouse protecting the entrance to pump rooms is to be in accordance with the following requirements.

- (1) The strength of the front wall is to be equivalent to that of the wall of the bridge.
- (2) The strength of side walls and after wall are to be equivalent to that of the front wall of the poop.
- (3) The height of doorway coamings is not to be less than 600 mm above the freeboard deck. However, the height may be reduced to not less than 450 mm for ships with a class notation of *Coasting Service*.

2.1.1.5 Length of Deep Tanks

The length of deep tanks is not to exceed $0.2L_f$ (m).

Chapter 4 LOADS

4.1 General

4.1.1 Overview

4.1.1.1 Structure and Overview of this Chapter

This Chapter specifies the additional requirements shown in **Table 4.1.1-1** as the loads used for the formulae and strength assessments to determine the scantlings specified in **Part 2-7** and **Part 1**.

Table 4.1.1-1 Overview of Chapter 4

Section	Title	Overview
4.1	General	General requirements
4.2	Loads to be Considered in Local Strength	Additional requirements for loads to be considered for the local strength specified in Chapter 6 and Chapter 6, Part 1 .
4.3	Loads to be Considered in Strength of Primary Supporting Structures	Additional requirements for loads to be considered for strength of primary supporting structures specified in Chapter 7 and Chapter 7, Part 1 .
4.4	Loads to be Considered in Strength Assessment by Cargo Hold Analysis	Additional requirements for loads to be considered for strength assessment by cargo hold analysis specified in Chapter 8 and Chapter 8, Part 1 .
4.5	Loads to be Considered in Fatigue	Additional requirements for loads to be considered for fatigue strength assessment specified in Chapter 9 and Chapter 9, Part 1 .

4.2 Loads to be Considered in Local Strength

4.2.1 General

4.2.1.1 General

1 The loads to be considered in the requirements of local strength specified in **Chapter 6** and **Chapter 6, Part 1** are to also be in accordance with **4.2**.

2 Additional requirements for loads in the maximum load condition are to be in accordance with **4.2.2**.

4.2.2 Maximum Load Condition

4.2.2.1 Lateral Loads

1 When applying **4.4.2, Part 1**, the parameters (GM , z_G , etc.) required to calculate pressure dynamic pressure due to cargo are to be values in the full load condition regardless of the cargo density to be considered. However, the values in **Table 4.2.2-1** may be used if the parameters are not available.

2 Where loads acting on the supporting structures of independent prismatic tanks are calculated, the vertical envelope acceleration a_{ze} specified in **4.2.4, Part 1** is to be considered. The parameters (GM , z_G , etc.) required to calculate the loads are to be the same as specified in -1 above.

3 In applying **4.4.2, Part 1**, the parameters (GM , z_G , etc.) required to calculate pressure dynamic pressure due to ballast water in ballast tanks are to be the values in the ballast condition. The same parameters are to be applied where the dynamic pressure due to

liquid other than ballast water, such as the pressure due to fuel oil tank, is considered. For ships loaded with ballast water in their cargo tanks in the emergency ballast condition, the parameters required to calculate dynamic pressure due to the ballast water are to be the values in the emergency ballast condition. However, the values in [Table 4.2.2-1](#) may be used if the parameters are not available.

Table 4.2.2-1 Simplified Formulae of parameters

Loading condition	Draught T_{LC} (m) in the midship part	Z coordinate z_G (m) of the centre of gravity of the ship	Metacentric height GM (m)	Radius of gyration K_{xx} (m)
Full load condition	T_{SC}	$0.25 \frac{B}{C_B}$	$\frac{T_{SC}}{2} + \frac{B^2}{T_{SC} C_B} \frac{3C_W - 1}{24} - z_G$	$0.35B$
Ballast condition	T_{BAL}	$0.20 \frac{B}{C_{B,LC}}$	$\frac{T_{LC}}{2} + \frac{B^2}{T_{LC} C_{B,LC}} \frac{3C_{W,LC} - 1}{24} - z_G$	$0.40B$
Emergency Ballast condition	T_{BAL-E}	$0.20 \frac{B}{C_{B,LC}}$	$\frac{T_{LC}}{2} + \frac{B^2}{T_{LC} C_{B,LC}} \frac{3C_{W,LC} - 1}{24} - z_G$	$0.40B$

4.3 Loads to be Considered in Strength of Primary Supporting Structures

4.3.1 General

4.3.1.1 General

1 The loads to be considered in the requirements of strength of primary supporting structures specified in [Chapter 7](#) and [Chapter 7, Part 1](#) are to be in accordance with [4.3](#).

2 Additional requirements for loads in maximum load conditions are to be in accordance with [4.3.2](#).

3 Additional requirements for loads in the harbour condition are to be in accordance with [4.3.3](#).

4.3.2 Maximum Load Condition

4.3.2.1 General

1 Loads for simple girders are to also in accordance with the relevant requirements of [4.2](#).

2 The loads specified in [Table 4.3.2-1](#) are to be considered for double hull. However, where deemed necessary by the Society, additional loading patterns taken the loading conditions into account specified in the loading manual may be requested.

Table 4.3.2-1 Loads to be Considered in Maximum Load Condition

Structures to be assessed		Loading patterns ⁽¹⁾			Equivalent design wave	Difference between external and internal pressure to be considered (kN/m^2)
		Draught(m)	Vertical still water bending moment ($kN-m$)	Loaded to be considered		
Double bottom	S1 ⁽²⁾	$0.9T_{SC}$	$M_{SV\ max}$	None	HM-1 / HM-2	Double bottom: P_{DB} Double side: P_{DS}
	S2 ⁽³⁾	$0.6T_{SC}$	$M_{SV\ min}$	Liquid cargo		
Double side	S3 ⁽²⁾	$0.9T_{SC}$	$M_{SV\ min}$	None	BP-1P / BP-1S	
	S4 ⁽³⁾	$0.6T_{SC}$	$M_{SV\ min}$	Liquid cargo		

Notes:

- (1) For the ships designed with the emergency ballast condition, the loading condition is to be considered in maximum load condition
- (2) For the ships designed so that the draught is smaller than $0.9T_{SC}$ where the cargo tank to be assessed is empty, the draught may be considered. In this case, it is clearly stated in the loading manual that exceeding the draught is not allowed where the cargo tank is empty.
- (3) For the ships designed so that the draught is greater than $0.6T_{SC}$ where the cargo tank to be assessed is loaded, the draught may be considered. In this case, it is clearly stated in the loading manual that being less than the draught is not allowed where the cargo tank is loaded.

4.3.2.2 External Pressure

For the requirements of double hull, the hydrostatic pressure and the hydrodynamic pressure at the equivalent design wave specified in **Table 4.3.2-2** are to be considered.

Table 4.3.2-2 External and Internal Pressure to be Considered

Structures to be assessed		$P_{DB}(kN/m^2)$ ⁽¹⁾⁽²⁾	$P_{DS}(kN/m^2)$ ⁽¹⁾⁽²⁾
Double bottom	S1 ⁽³⁾	$P_{exs} + P_{exw}$	$P_{exs} + P_{exw}$
	S2	$P_{exs} + P_{exw} - (P_{ls} + P_{ld})$	$P_{exs} + P_{exw} - (P_{ls} + P_{ld})$
Double side	S3	$P_{exs} + P_{exw}$	$P_{exs} + P_{exw}$
	S4	$P_{exs} + P_{exw} - (P_{ls} + P_{ld})$	$P_{exs} + P_{exw} - (P_{ls} + P_{ld})$

Notes:

P_{exs} , P_{exw} : Hydrostatic and Hydrodynamic pressure (kN/m^2) act on bottom shell in case of P_{DB} . Those values act on side shell in case of P_{DS} . Each value is calculated in accordance with **4.6.2.4, Part 1**.

P_{ls} , P_{ld} : Static and dynamic pressure due to liquid cargo (kN/m^2) act on inner bottom plating in case of P_{DB} . Those values act on side shell in case of P_{DS} . Each value is calculated in accordance with **4.6.2.5, Part 1**.

- (1) The parameters (GM , z_G , K_{XX}) required to calculate loads is given by the follows.
 S1, S3: As given by the formula for full load condition specified in **Table 4.2.2-1**
 S2, S4: As given by the formula for ballast condition specified in **Table 4.2.2-1**
- (2) Load calculation points is in accordance with **7.3.1.5, Part 1** for all loading conditions.
- (3) P_{exw} is to be not less than the value of P_{exw} for HM-2 at x_G , which is the X coordinate (m) at the centre of gravity of the ship.

4.3.2.3 Internal Pressure

For the requirements of double hull, internal pressure due to liquid cargo is to be considered in accordance with [Table 4.3.2-2](#).

4.3.2.4 Vertical Bending Moments

1 The vertical still water bending moments and the vertical wave induced bending moments for the equivalent design waves specified in [4.3.2.1-2](#) are to be considered for the requirements of double hull structures.

2 The vertical wave induced bending moment considered for each equivalent design wave is to be in accordance with [4.6.2.10, Part 1](#).

4.3.3 Harbour Condition

4.3.3.1 General

The loads specified in [Table 4.3.3-1](#) are to be considered in the requirements for double hull.

Table 4.3.3-1 Loads to be Considered in Harbour Condition

Structures to be assessed		Loading patterns ⁽¹⁾			Difference between external and internal pressure to be considered (kN/m^2)
		Draught(m)	Vertical bending moment in harbour($kN\cdot m$)	Loaded to be considered	
Double bottom	$P1^{(1)}$	T_{SC}	M_{PT_max}	None	Double bottom: P_{DB} Double side: P_{DS}
	$P2^{(2)}$	T_{BAL}	M_{PT_min}	Liquid cargo	
Double side	$P3^{(1)}$	T_{SC}	M_{PT_max}	None	
	$P4^{(2)}$	T_{BAL}	M_{PT_min}	Liquid cargo	

Notes:

(1) For ships designed so that their draught is smaller than T_{SC} when the cargo tank to be assessed is empty, the smaller draught may be considered. In such cases, it is to be clearly stated in the Loading Manual that exceeding the smaller draught is not allowed when the cargo tank is empty.

(2) For ships designed so that their draught is greater than T_{BAL} when the cargo tank to be assessed is loaded, the greater draught may be considered. In such cases, it is to be clearly stated in the Loading Manual that being less than the greater draught is not allowed when the cargo tank is loaded.

4.3.3.2 External Pressure

For the requirements of double hull, the hydrostatic pressure is to be considered in accordance with [Table 4.3.3-2](#).

Table 4.3.3-2 External and Internal Pressure to be Considered

Structures to be assessed		$P_{DB}(kN/m^2)^{(1)}$	$P_{DS}(kN/m^2)^{(1)}$
Double bottom	$P1$	P_{exs}	P_{exs}
	$P2$	$P_{exs} - P_{ls}$	$P_{exs} - P_{ls}$
Double side	$P3$	P_{exs}	P_{exs}
	$P4$	$P_{exs} - P_{ls}$	$P_{exs} - P_{ls}$

Notes:

P_{exs} , P_{exw} : Hydrostatic pressure (kN/m^2) act on bottom shell in case of P_{DB} . The value act on side shell in case of P_{DS} . Each value is calculated in accordance with [4.6.2.4, Part 1](#).

P_{ls} , P_{ld} : Static pressure due to liquid cargo (kN/m^2) act on inner bottom plating in case of P_{DB} . The value act on side shell in case of P_{DS} . Each value is calculated in accordance with [4.6.2.5, Part 1](#).

(1) Load calculation points is in accordance with **7.3.1.5, Part 1** for all loading conditions.

4.3.3.3 Internal Pressure

For the requirements of double hull, the internal pressure due to liquid cargo is to be considered in accordance with **Table 4.3.3-2**.

4.3.3.4 Vertical Bending Moment in Harbour

The vertical bending moment in harbour to be considered for the requirements of double hull is to be in accordance with **4.3.3.1**.

4.4 Loads to be Considered in Strength Assessment by Cargo Hold Analysis

4.4.1 General

4.4.1.1 General

1 The loads to be considered for strength assessment by cargo hold analysis specified in **Chapter 8** and **Chapter 8, Part 1** are to also be in accordance with **4.4**.

2 Additional requirements for loads in the maximum load condition are to be in accordance with **4.4.2**.

3 Additional requirements for loads in the harbour condition are to be in accordance with **4.4.3**.

4.4.2 Maximum Load Condition

4.4.2.1 Loading Conditions

In applying **4.6.2.1, Part 1**, as for dangerous chemical bulk carriers, the loading conditions specified in **Table 4.4.2-1** are to be considered. Loading conditions specified in the loading manual may be required additionally where deemed necessary by the Society.

Table 4.4.2-1 Loads in Maximum Load Condition

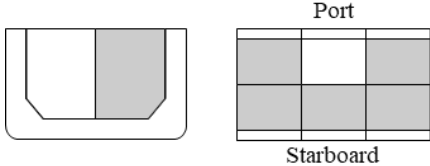
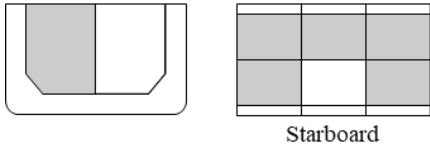
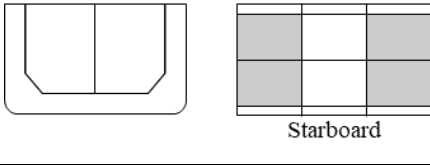
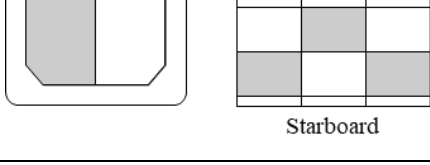
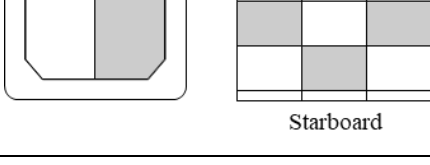
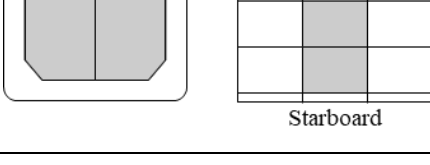
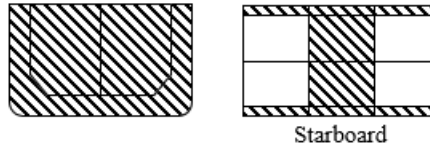
Loading condition	Loading pattern		Draught	Vertical still water bending moment	Equivalent design wave
Partial load condition	S1		$0.9T_{SC}$	M_{SV_max}	HM-2/FM-2
				M_{SV_min}	HM-1/FM-1 BR-1P/S BP-1P/S
Partial load condition	S2		$0.9T_{SC}$	M_{SV_max}	HM-2/FM-2
				M_{SV_min}	HM-1/FM-1 BR-1P/S BP-1P/S
Jumping load condition	S3		$0.9T_{SC}$	M_{SV_max}	HM-2/FM-2
				0	HM-1/FM-1 BR-1P/S BP-1P/S
Zig-zag load condition	S4		$0.6T_{SC}$	M_{SV_min}	HM-1/FM-1 BR-1P/S BP-1P/S
Zig-zag load condition	S5		$0.6T_{SC}$	M_{SV_min}	HM-1/FM-1 BR-1P/S BP-1P/S
Jumping load condition	S6		$0.6T_{SC}$	0	HM-2/FM-2
				M_{SV_min}	HM-1/FM-1 BR-1P/S BP-1P/S
Emergency Ballast condition	S7		T_{BAL-E}	M_{SV_min}	HM-1/FM-1 BR-1P/S BP-1P/S
■: Liquid cargo ▨: Ballast water					
Notes: The radius of gyration (m) around the X -axis is taken as $0.38B$. However, the value calculated based on the weight distribution according to the loading condition under consideration may be used.					

4.4.2.2 Hull Girder Loads

In applying **4.6.2.10, Part 1**, the vertical still water bending moment for the loading condition under consideration is to be in accordance with **4.4.2.1**.

4.4.3 Harbour Condition

4.4.3.1 Loading Conditions

In applying **4.6.3.1, Part 1**, the loading conditions specified in **Table 4.4.3-1** are to be considered.

Table 4.4.3-1 Loading Conditions to be Considered in Harbour Condition

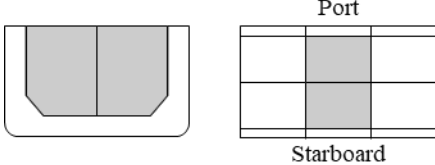
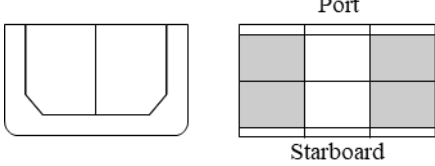
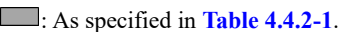
Loading condition	Loading pattern		Draught	Vertical bending moment in the harbour
Harbour condition	P1		T_{BAL}	M_{PT_min}
	P2		T_{SC}	M_{PT_max}
				

4.4.3.2 Hull Girder Loads

In applying **4.6.3.5, Part 1**, the value of M_{PT} is to be taken as the value specified in **4.4.3.1**.

4.5 Loads to be Considered in Fatigue

4.5.1 General

4.5.1.1 General

1 The loads to be considered for fatigue strength assessments specified in **Chapter 9** and **Chapter 9, Part 1** are to be in accordance with **4.5**.

2 Additional requirements for loads in the cyclic load condition are to be in accordance with **4.5.2**.

4.5.2 Cyclic Load Condition

4.5.2.1 Loading Conditions

In applying **4.7.2.1, Part 1**, the loading conditions specified in **Table 4.5.2-1** are to be considered. The loading conditions specified in the loading manual may be required additionally where deemed necessary by the Society.

Table 4.5.2-1 Loads in Cyclic Load Condition

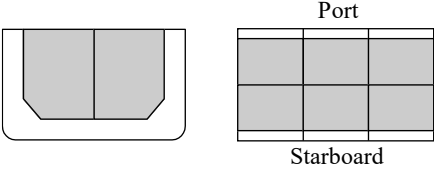
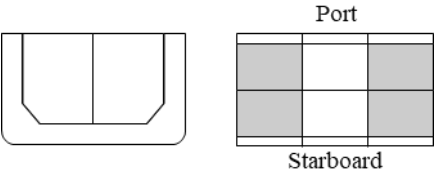
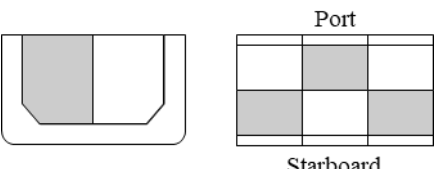
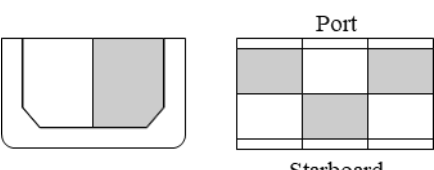
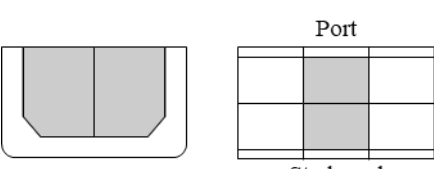
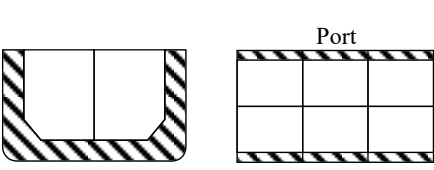
Loading condition	Loading pattern		Draught	Vertical still water bending moment	Equivalent design wave
Full load condition	FA1		T_{SC}	Values for the loading conditions under consideration	HM FM BR BP
Jumping load condition	FA2		$0.9T_{SC}$		
Zig-zag load condition	FA3		$0.6T_{SC}$		
	FA4		$0.6T_{SC}$		
Jumping load condition	FA5		$0.6T_{SC}$		
Ballast condition	FA6		T_{BAL}		

■, ▨: As specified in Table 4.4.2-1.

Chapter 6 LOCAL STRENGTH

6.1 Independent Prismatic Tanks

6.1.1 Plates and Stiffeners

6.1.1.1

The plates and stiffeners of independent prismatic tanks respectively are to be in accordance with 6.3 and 6.4, Part 1. However, in applying 6.3 and 6.4, Part 1, the coefficients C_a and C_s related to the influence of axial force are to be assessed as 1.0.

6.1.2 Supporting Structures in Independent Prismatic Tanks

6.1.2.1 General

The arrangements and scantlings of the supporting structures of independent prismatic tanks are to comply with 6.1.2. However, this does not apply to cases where such arrangements and scantlings are determined by other appropriate methods.

6.1.2.2 Materials*

- 1 Materials deemed appropriate by the Society are to be used for supporting structures.
- 2 For the materials referred to in -1 above, documents showing their properties at room temperature and operating temperature are to be submitted.

6.1.2.3 Strength Criteria

Compressive stresses $\sigma_a(N/mm^2)$ acting on each plate which composes the supporting structures, excluding top plate, is to comply with the following criteria:

$$\sigma_a < \sigma_{cr}$$

σ_a : The compressive stress acting on each plate which composes the supporting structures, excluding top plate, as given by the following:

$$\sigma_a = \frac{F_a}{A_{min}} \quad (N/mm^2)$$

Where:

F_a : Load acting on the supporting structures as given by the following:

$$F_a = (\rho_L V_t \times 10^3 + m_T)(g + a_{ze}) \quad (N)$$

ρ_L : Cargo density (ton/m^3)

V_t : Tank volume (m^3) supported by the supporting structure under consideration

m_T : Mass of tank, insulation and equipment (kg)

a_{ze} : Vertical envelope acceleration acting on the centre of gravity of the cargo tank under consideration, according to 4.2.2.1

A_{min} : Minimum horizontal sectional area (mm^2) which is obtained by subtracting half of corrosion addition t_c from all side of the plates (See Fig. 6.1.2-1)

σ_{cr} : Allowable stress obtained as follows, whichever is smaller.

$$\frac{\sigma_{yd}}{1.33} \quad (N/mm^2)$$

$$C_x \sigma_{yd} \quad (N/mm^2)$$

Where:

σ_{yd} : Yield stress (N/mm^2) of the material used for the supporting structure

C_x : Reduction factor for each plate which composes the supporting structures, excluding top plates, as obtained by Table 6.1.2-1. Assessed plate which is not rectangular may be approximated using Table 6.1.2-2.

Fig. 6.1.2-1 Example of Supporting Structure (Excluding Top Plate) and the Relevant Minimum Horizontal Sectional Area

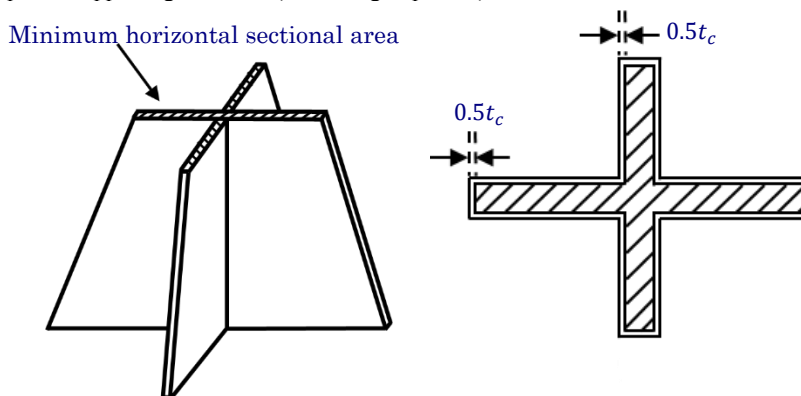

Table 6.1.2-1 Reduction Factor for Plane Plate Panels

	Aspect ratio α	Buckling factor K	Reduction factor C_x
1 	$\alpha \geq 1$	$K = 4$	$C_x = 1$ for $\lambda \leq 0.8$ $C_x = 1.13 \left(\frac{1}{\lambda} - \frac{0.22}{\lambda^2} \right)$ for $\lambda > 0.8$
2 	$\alpha > 0$	$K = 0.425 + \frac{1}{\alpha^2}$	$C_x = 1$ for $\lambda \leq 0.7$ $C_x = \frac{1}{\lambda^2 + 0.51}$ for $\lambda > 0.7$

Explanations for boundary conditions:

----- plate edge free

————— plate edge simply supported

λ : Reference degree of slenderness, to be taken as:

$$\lambda = \sqrt{\frac{\sigma_{yd}}{K\sigma_E}}$$

σ_E : Reference stress (N/mm^2), to be taken as:

$$\sigma_E = 0.9E \left(\frac{t}{l_a} \right)^2$$

Where:

t : Net plate thickness (mm) of plate member

l_a : Length of the side of the plate panel (mm)

Table 6.1.2-2 Trapezoidal Panel Approximation

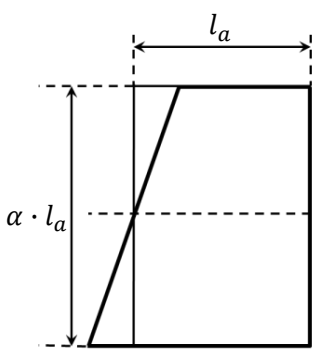
Shape	Approximation
 <p>The diagram shows a trapezoidal panel on the left and its rectangular approximation on the right. The trapezoid has a vertical line representing the mean value of the bases, labeled l_a. The height of the trapezoid is indicated as $\alpha \cdot l_a$. The approximation is a rectangle with the same height and width l_a.</p>	<p>A rectangle is derived with l_a being the mean value of the bases and $\alpha \cdot l_a$ being the height of the original panel.</p>

Chapter 7 STRENGTH OF PRIMARY SUPPORTING STRUCTURES

7.1 General

7.1.1 Application

7.1.1.1

1 The requirements in this Chapter apply to ships of less than 150 m in length L_C .

2 Notwithstanding -1 above, strength assessments for deck girders with respect to deck loads and green sea loads are to be carried out in accordance with this Chapter.

3 For the double bottom and double-side skin structure, the requirements of the double hull structure specified in 7.3, Part 1 are to be applied. For other girder members that can be regarded as simple girders, the requirement of the simple girder specified in 7.2, Part 1 are to be applied.

7.1.1.2 Application Example of Assessment Model for Oil Tanker

1 An application example of an assessment model applying 7.2 and 7.3, Part 1 is shown in Fig. 7.1.1-1.

2 For girder members deemed to be simple girders with structures different from that shown in Fig. 7.1.1-1, the boundary conditions and acting loads are to be considered, and the assessment model from Table 7.2.1-2, Part 1 is to be appropriately selected.

Fig. 7.1.1-1 Application Example of Oil Tanker

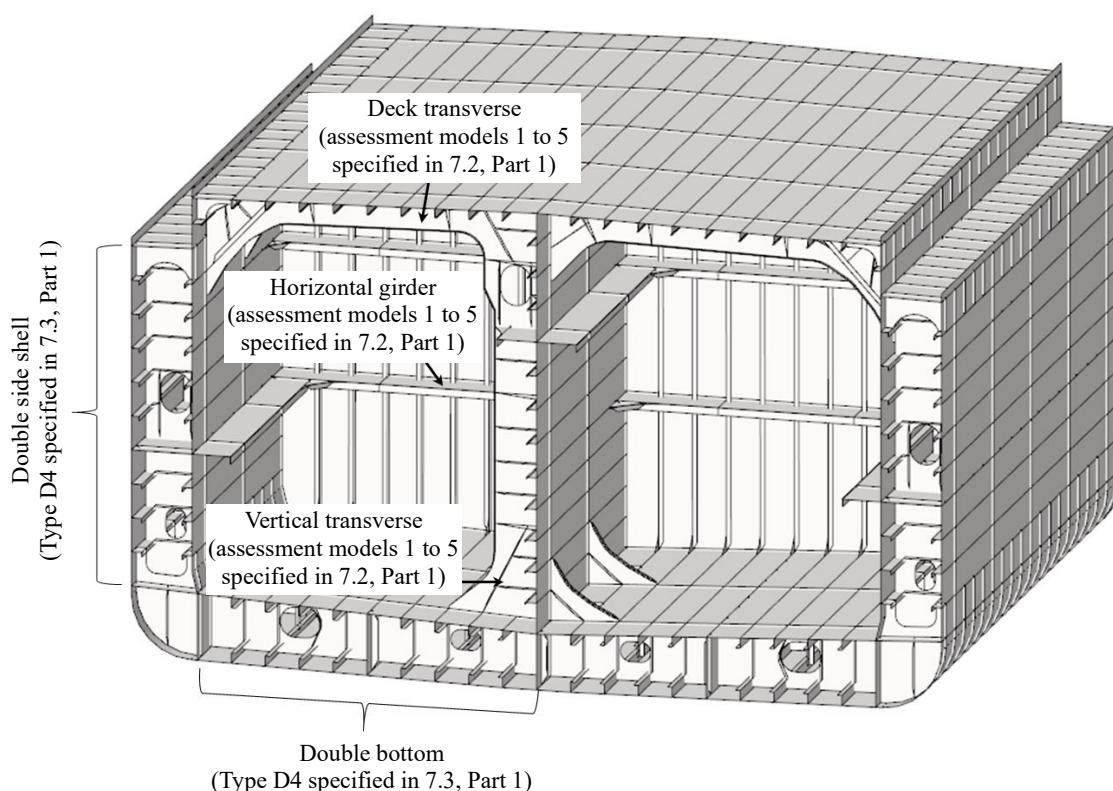

7.1.1.3 Application Example of Assessment Model for Chemical Tanker

1 An application example of an assessment model applying 7.2 and 7.3, Part 1 is shown in Fig. 7.1.1-2.

2 For girder members that have a structure not shown in Fig. 7.1.1-2 and can be regarded as a simple girder, the boundary conditions and acting loads are to be considered, and an assessment model from Table 7.2.1-2, Part 1 is to be appropriately selected.

Fig. 7.1.1-2 Application Example of Chemical Tanker

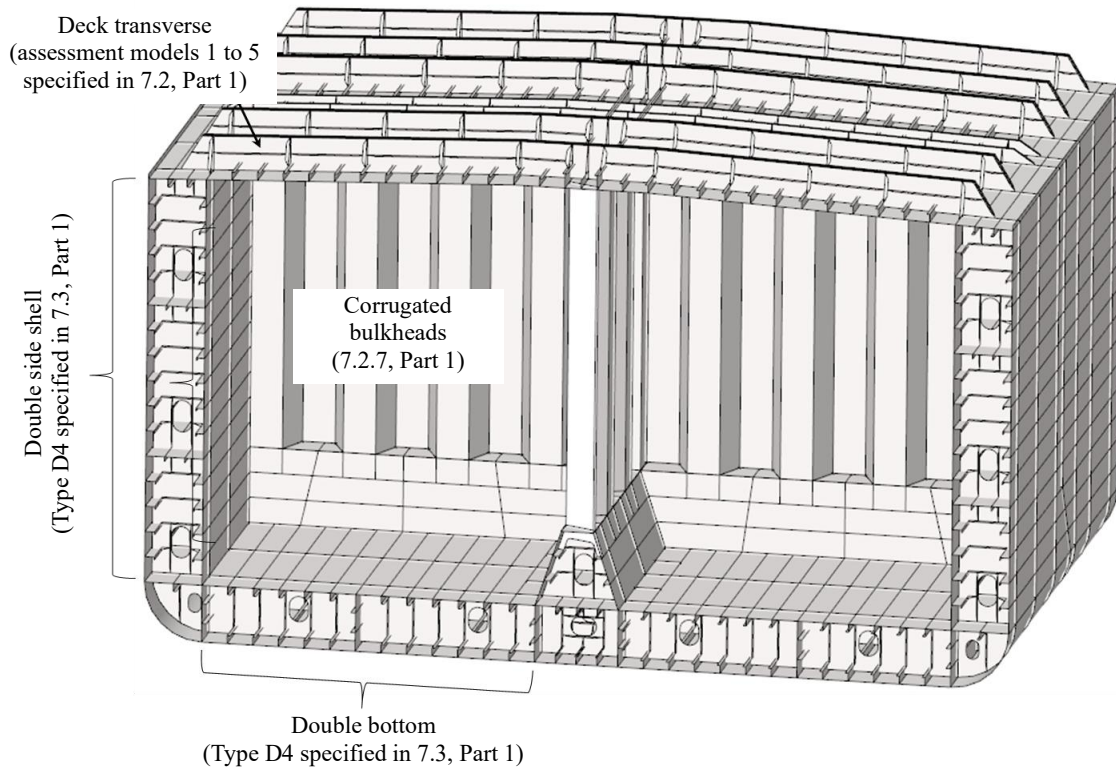

7.2 Independent Prismatic Tanks

7.2.1 Girders Supporting Stiffeners

7.2.1.1

Stiffening girders supporting the plate stiffeners of independent prismatic tanks are to be in accordance with [7.2, Part 1](#). However, in applying said [7.2](#), the coefficient C_s related to the influence of axial force is to be taken as 1.0.

Chapter 8 STRENGTH ASSESSMENT BY CARGO HOLD ANALYSIS

8.1 General

8.1.1 Overview

8.1.1.1 Structure and Overview of this Chapter

- 1 This Chapter specifies a method for strength assessment by cargo hold analysis in tankers.
- 2 The structure and overview of this Chapter are shown in [Table 8.1.1-1](#).

Table 8.1.1-1 Overview of Chapter 8

Section	Title	Overview
8.1	General	Additional requirements related to the overview and application of this Chapter
8.2	Evaluation Area and Members to be Assessed	Additional requirements related to evaluation area and members to be assessed
8.3	Structural Models	Additional requirements related to extent of model, members to be modelled, meshing, etc.
8.4	Boundary Conditions and Loads Conditions	Additional requirements related to boundary conditions and loads conditions
8.5	Strength Assessments	Additional requirements related to yield strength assessments

8.1.2 Application

8.1.2.1

Ships that strength assessment by cargo hold analysis is required, which fall under [8.1.2.1-1\(2\), Part 1](#) are dangerous chemical bulk carriers with the length L_C of 150 m or more.

8.2 Evaluation Area and Members to be Assessed

8.2.1 Evaluation Area

8.2.1.1 Members to be Assessed

In applying [8.2.2.1, Part 1](#), the structures and members to be assessed are to be as follows for dangerous chemical bulk carriers with a length L_C of 150 m or more.

- (1) Double bottom structures (bottom shell, inner bottom plating, centre girder, side girder and floor)
- (2) Double side shell structures (side shell, longitudinal bulkhead, side stringer and side transverse)
- (3) Deck structure (upper decks and deck transverses)
- (4) Bulkhead structures (transverse bulkheads and longitudinal bulkheads)
- (5) Other members and locations deemed necessary by the Society

8.3 Structural Models

8.3.1 General

8.3.1.1 Extent of Model

In applying [8.3.1.1, Part 1](#), the model is, in principle, to represent three adjacent cargo holds with the target the middle and the

full depth and the full width of the holds are to be modelled.

8.3.1.2 In way of Lower End of Vertically Corrugated Bulkheads

1 In applying **8.3.3.1-2, Part 1**, plating and primary supporting members around the lower end of vertically corrugated bulkheads are to be modelled by shell elements with a mesh size of $100\text{ mm} \times 100\text{ mm}$ or less.

2 In applying -1 above, members for reinforcements directly under vertically corrugated bulkheads across the inner bottom plating are to be appropriately modelled. Shell elements are to be used for modelling if necessary.

8.4 Boundary Conditions and Loads Conditions

8.4.1 Boundary Conditions

8.4.1.1

In applying **8.5.1, Part 1**, boundary conditions are to be in accordance with **8.4.1, Part 2-2**.

8.4.2 Loads Conditions

8.4.2.1 Loads to be Considered

In applying **8.5.2, Part 1**, loads based also upon the additional requirements specified in **4.4** are to be considered.

8.4.2.2 Methods for Applying Moments to Structural Models

In applying **8.5.2, Part 1**, the vertical bending moment and horizontal bending moment act on the target hold are to be adjusted in accordance with **8.4.2, Part 2-2**.

8.5 Strength Assessments

8.5.1 Yield Strength Assessments

8.5.1.1 Reference Stress

1 In applying **8.6.1.1, Part 1**, the averaged stresses of multiple elements within the range deemed appropriate by the Society may be taken as the reference stress for locations where the mesh size specified in **8.3.1.2** is applied. A range for which the web depth of the vertically corrugated bulkhead is divided into three parts (that is, approximately $300\text{ mm} \times 300\text{ mm}$) is to be taken as the standard range.

2 In applying -1 above, stress is not to be averaged across structural discontinuities.

Chapter 9 FATIGUE

9.1 General

9.1.1 Application of Fatigue Requirements

9.1.1.1 Application

Ships with a length L_C of 150 m or more are to be assessed for fatigue strength based on the hot spot stresses obtained by simplified stress analysis according to **9.3, Part 1** and finite element analysis according to **9.4, Part 1**.

9.2 Structural Details to be Assessed

9.2.1 Structural Details Subject to Finite Element Analysis

9.2.1.1

1 Critical structural details to be assessed for fatigue strength by finite element analysis according to **9.4, Part 1** are shown in **Table 9.2.1-1**.

2 Notwithstanding the requirements specified in -1 above, where documents demonstrating sufficient fatigue strength are submitted and deemed appropriate by the Society, the fatigue strength assessment of the structure may be omitted.

Table 9.2.1-1 Structural Details of Primary Members to be Assessed in the Hull Structure

No.	Critical structural details of hull structure
1	Intersections between inner bottom plating, bilge hopper plating, upper deck, lower stool, and corrugated bulkhead
2	Intersections between lower stool and inner bottom plating in way of bottom girder
3	Intersections of cross joints between side stringer and transverse bulkhead horizontal stringers
4	On-deck transverse girder toe
5	Intersections between transverse corrugated bulkhead and longitudinal corrugated bulkhead
6	Transverse bulkhead vertical web toe(intersections between inner bottom plating and upper deck)
7	Intersections between bilge hopper plating and inner bottom plating
8	Intersections between bilge hopper plating and inner longitudinal bulkhead
9	Other areas with large stress concentrations

9.3 Loading Conditions and Fraction of Time to be Considered

9.3.1 General

9.3.1.1

1 Standard loading conditions and fraction of time are to be in accordance with **Table 9.3.1-1** and **Table 9.3.1-2**.

2 Notwithstanding the requirements specified in -1 above, when considering loading conditions and fraction of time other than those in **Table 9.3.1-1** and **Table 9.3.1-2**, it is necessary to consider appropriate combinations.

Table 9.3.1-1 Standard Loading Conditions and Fraction of Time for Oil Tankers

Loading condition	Fraction of time $\alpha_{(j)}$
Full load condition (homogeneous loading)	50 %
Ballast condition	50 %

Table 9.3.1-2 Standard Loading Conditions and Fraction of Time for Chemical Tankers

Loading conditions	Fraction of time $\alpha_{(j)}$
Full load condition (homogeneous loading)	20%
Full load condition (alternate loading)	20%
Full load condition (zig-zag loading)	20%
Ballast condition	40%

9.4 Boundary Conditions and Load Conditions

9.4.1 Boundary Conditions

9.4.1.1

In applying [9.4.4.1, Part 1](#), the boundary conditions are to be in accordance with [8.4.1.1, Part 2-2](#).

9.4.2 Load Conditions

9.4.2.1 Method of Applying Moments to the Structural Model

In applying [9.4.4.2, Part 1](#), the method of applying moments to the structural model is to be in accordance with [8.4.2.2, Part 2-2](#). However, the vertical bending moment and horizontal bending moment ($kN-m$) specified in [Table 9.4.2-1](#) are to be used as M_{V-targ} and M_{H-targ} instead of those specified in [Table 8.4.2-1, Part 2-2](#).

 Table 9.4.2-1 M_{V-targ} and M_{H-targ}

	Cyclic load condition
Vertical bending moment M_{V-targ}	M_{V-HG}
Horizontal bending moment M_{H-targ}	M_{H-HG}
Note: M_{V-HG} , M_{H-HG} : Vertical bending moment and horizontal bending moment ($kN-m$) under cyclic load condition, to be in accordance with 4.7.2.10, Part 1 .	

9.5 Detailed Design Standards

9.5.1 General

9.5.1.1

The structural details of the end bracket of girder, and bracket or cross tie provided on the back side of the girder ([Fig. 9.5.1-1](#) and [Fig. 9.5.1-2](#)), are to be in accordance with [9.6.2.2, Part 1](#) when the stress is high.

Fig. 9.5.1-1 Intersections of Transverses Girders and Cross Ties

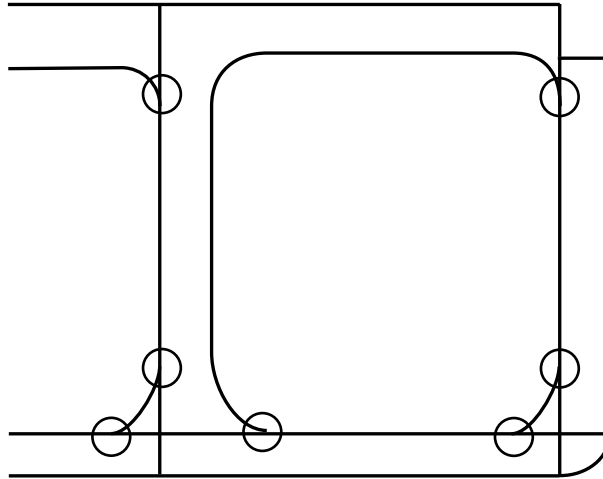
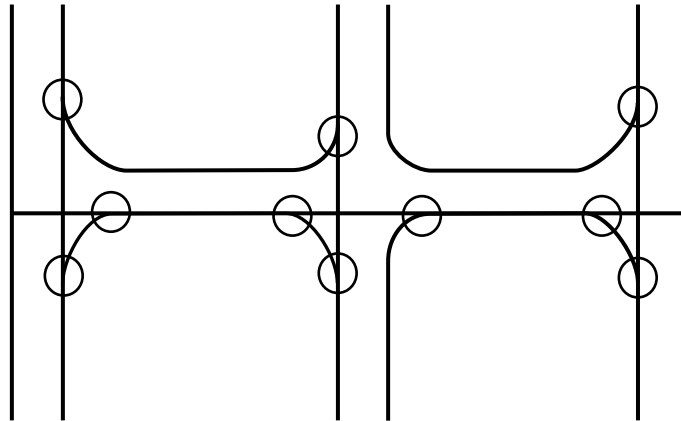

Fig. 9.5.1-2 Intersections of Horizontal Girders



Chapter 10 ADDITIONAL STRUCTURAL REQUIREMENTS

10.1 General

10.1.1 General

10.1.1.1 Structural Continuity

1 Primary structural members are to be so arranged to ensure strength continuity throughout cargo areas. In addition, structures in the forward and afterword parts of cargo areas are to be effectively strengthened so that strength continuity is not sharply impaired.

2 Sufficient consideration is to be given to the fixity at the ends of primary structural members with respect to their supporting and stiffening systems against out-of-plane deflections, and their construction is to minimize local stress concentrations.

3 At the forward and afterword ends of a cargo oil tank, precautions are to be taken to maintain continuity between the ends of the longitudinal bulkhead and the longitudinal members of the deck (See Fig. 10.1.1-1).

Fig. 10.1.1-1 Continuity of Longitudinal Bulkhead at Ends
Upper Deck

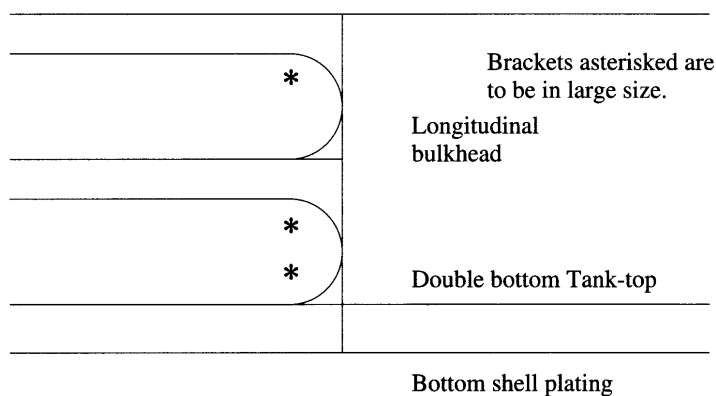

10.1.2 Primary Structural Members

10.1.2.1 General

1 Girders provided within the same plane are to be arranged to avoid sharp changes in strength and rigidity. Brackets of a suitable size are to be provided at the ends of girders, and bracket toes are to be sufficiently rounded.

2 Where the depth of longitudinal girders is large, stiffeners are to be arranged in parallel with the face plates.

3 Tripping brackets are to be provided on the web plate transverses at appropriate intervals and also at the inner edge of end brackets. Where width of face plates of each girder exceeds 180 mm on a one side, the tripping brackets are to support face plates as well.

4 Webs for the upper and lower end brackets of side transverses and vertical webs on longitudinal bulkhead and areas in the vicinity of their inner ends are to be stiffened specifically by closer spacing.

10.1.2.2 Structural Details

Structural details of transverses are to be in accordance with the following (1) and (2).

- (1) Additional stiffeners are to be provided for locations where shear stress and/or compressive stress are expected to be high (e.g. bracket parts at the ends of transverses). These locations are not to provide lightening holes, and are to be provided color plates for slots for penetration of longitudinals.
- (2) When angle bars are used instead of flat bars as stiffeners installed on transverses, their moments of inertia with effective plates are to be approximately equivalent to the required ones.

Chapter 12 WELDING

12.1 Welding in Tankers

12.1.1 Application

12.1.1.1

Regarding the welding of tankers, **Chapter 12, Part 1** is to apply for matters not specified in **12.1**.

12.1.2 Fillet Welding

12.1.2.1

The application of fillet welding to structural members within cargo areas is to be as given in **Table 12.1.2-1**.

12.1.2.2

The leg lengths of fillet welds in the areas given in the following **(1)** and **(2)** is to be at least 0.7 times the plate thickness as specified in this Chapter.

- (1) Fillet welds at the connections between the outermost girders in double bottoms and floors
- (2) Fillet welds at the connections between the lowermost girders in double side hulls and transverses

12.1.2.3

In areas where bending, shearing or axial force is particularly significant, the leg lengths of fillet welds are to be suitably increased or are to be bevelled and welded.

Table 12.1.2-1 Application of Fillet Welding

Column	Item	Application	Kind of weld
1	Web plates	Shell, deck, longitudinal bulkhead or inner bottom plating	F1
2		Web plates	F1
3		Face plates	F2
4	Slots in web plates	Web plates of longitudinal frames, beams and horizontal stiffeners on longitudinal bulkheads	F2
5	Tripping brackets and stiffeners provided for web plates	Web plates	F3
6		Longitudinal frames, beams and horizontal stiffeners for longitudinal bulkheads	F1
7	Longitudinal frames, beams and horizontal stiffeners for longitudinal bulkheads	Shell, deck or longitudinal bulkhead plating	F3
8	Cross ties	Members forming cross ties (web plates to face plates)	F3
9		Face plates of transverses or girders	F1

Notes:

Where the end bracket toe radius is small, it is recommended that F1 be used for the appropriate length at the bracket toe.

Chapter 14 EQUIPMENT

14.1 Special Requirements for Hatch Covers

14.1.1 General

14.1.1.1 Ships Having Unusually Large Freeboards

Ships considered to have unusually large freeboards may be given special consideration with regards to [14.1](#).

14.1.2 Cargo Oil Tank Hatch Covers

14.1.2.1 General

1 The thickness of hatch coaming plate is not to be less than 10 mm . Where the length and coaming height of a hatchway exceed 1.25 m and 760 mm respectively, vertical stiffeners are to be provided to side or end coamings, and the upper edges of coamings are to be suitably stiffened.

2 Hatch covers are to be constructed of steel or other approved materials. The construction of steel hatch cover is to comply with the following **(1)** to **(4)**. The construction of hatch covers for materials other than steel is to be at the discretion of the Society.

- (1) Cover plate thickness is not to be less than 12 mm .
- (2) Where hatchway area exceeds 1 m^2 but does not exceed 2.5 m^2 , cover plates are to be stiffened by flat bars of 100 mm in depth spaced not more than 610 mm apart. Where cover plates are 15 mm or more in thickness, stiffeners may be dispensed with.
- (3) Where hatchway area exceeds 2.5 m^2 , cover plates are to be stiffened by flat bars of 125 mm in depth spaced not more than 610 mm apart.
- (4) For circular hatchway coamings, fasteners or devices with equivalent efficacy are to be placed at a centre distance of 457 mm or less. For rectangular hatchway coamings, fasteners or devices with equivalent efficacy are to be placed within 230 mm from each corner and at a centre distance of 380 mm or less and the structure is to allow hatch cover plates to be attached so as to be oiltight.

14.1.2.2 Hatch Covers of Glass-Fibre Reinforced Plastics

Where glass-fibre reinforced plastic hatch covers are provided for cargo oil tanks, they are to comply with the following requirements.

- (1) The basic material is to be of a fire-resistant nature.
- (2) Model tests are to be carried out according to the standard fire test method specified in [3.2.47, Part R](#), through exposing the inside face to fire. This standard fire test is to be carried out for a duration of not less than 20 minutes at a highest temperature of 790 °C to confirm that there is no passage of flame until the end of the first 20 minutes of the test.
- (3) Steaming tests are to be carried out to confirm that there are no deformations causing leakage.
- (4) Models of different dimensions are to be subject to hydraulic tests at pressures not less than 27.5 kPa to confirm their strength.
- (5) Covers are to be designed to be set either at a full-open position or full-close position only. Notices indicating this manner of handling is to be fitted to cover upper surfaces.

14.1.2.3 Materials of Tank Cleaning Hatch Covers

1 Materials used for tank cleaning hatch covers provided for cargo oil tanks are to be as follows.

- (1) Covers may be constructed of brass, bronze or steel, but are not to be constructed of aluminium.
- (2) Synthetic materials such as glass-fibre reinforced plastics materials may be used only when all the requirements under [14.1.2.2](#) can be met.

2 Tank hatch cleaning cover tightening devices are to be capable of keeping ample tightness under pressures corresponding to water heads of 2.4 m above tank tops. If such devices are constructed as mentioned below or equivalent, the hatch coaming height required by [14.6.9.1-2, Part 1](#) may be reduced in accordance with [14.6.9.1-1, Part 1](#).

- (1) Where liners are placed on tank tops and covers are tightened by bolts, the pitch between bolts is not to exceed 150 mm , and the number of bolts is not to be less than ten. The use of parts such as butterfly-nuts that allow the hatches to be opened by simple manipulation is not permitted. Furthermore, liners are to be constructed of the same materials as the upper deck.
- (2) Hatches having hinged covers with arms are to have coamings, and their construction is to be such that they cannot be opened

simply by hand (See Fig. 14.1.2-1).

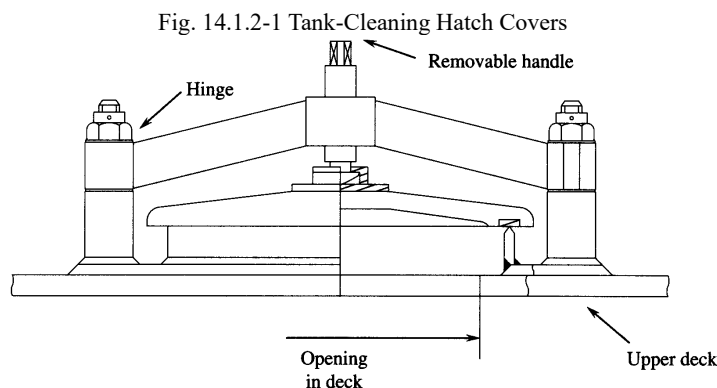

14.1.3 Hatch Covers for Tanks Other Than Cargo Oil Tanks

14.1.3.1

At exposed positions one freeboards and forecastle decks or on the tops of expansion trunks, hatchways serving spaces other than cargo oil tanks are to be provided with steel watertight covers having scantlings complying with 14.6, Part 1.

14.2 Special Requirements for Freeing Arrangements

14.2.1 Freeing Arrangements

14.2.1.1 General

- 1 Ships with bulwarks are to be provided with open rails for at least half the length of the exposed areas of freeboard decks or are to be provided with other effective freeing arrangements. The upper edges of sheer strakes are to be kept as low as practicable.
- 2 Notwithstanding -1 above, open guardrails installed on more than half the length of the exposed areas of freeboard decks may be replaced by freeing ports in the lower parts of bulwarks for at least 33 % of the total bulwark area.
- 3 Where superstructures are connected by trunks, open rails are to be provided for the entire length of exposed areas of freeboard decks.
- 4 Gutter bars 300 mm or more in height fitted around the weather decks of tankers in way of cargo manifolds and cargo piping are to be treated as bulwarks. Freeing ports are to be arranged in accordance with 14.9, Part 1. Closures attached to the freeing ports for use during loading and discharge operations are to be arranged in such a way that jamming cannot occur while at sea.

Part 2-8 SHIPS CARRYING LIQUEFIED GASES IN BULK (INDEPENDENT SPHERICAL TANKS OF TYPE B)

Chapter 1 GENERAL

1.1 General

1.1.1 Application

1.1.1.1 Application of this Part

1 The hull construction and equipment of ships intended to be registered as ships with independent spherical tanks of type B carrying liquefied gases in bulk, affixed with the notation “*Independent Spherical Tanks of Type B*” (abbreviated as *IST Type B*), are to be in accordance with the requirements in [Part 2-8](#) in addition to [Part 1](#).

2 The requirements in [Part 2-8](#) are generally for ships having double bottoms, double side structure and single deck, and in which a spherical or similar cargo tank is supported by a tank skirt and a tank cover is provided on the upper deck.

3 Ships with independent spherical tanks of type B carrying liquefied gases in bulk with a different construction from that specified in -2 above, to which the requirements in this Part are considered to be not applicable, are to be at the discretion of the Society.

1.2 Definitions

1.2.1 Naming Convention

1.2.1.1 Structural Nomenclature

[Fig. 1.2.1-1](#) show the common structural nomenclature used in [Part 2-8](#).

Fig. 1.2.1-1 Ships Carrying Liquefied Gases in Bulk (Independent spherical tanks of type B)

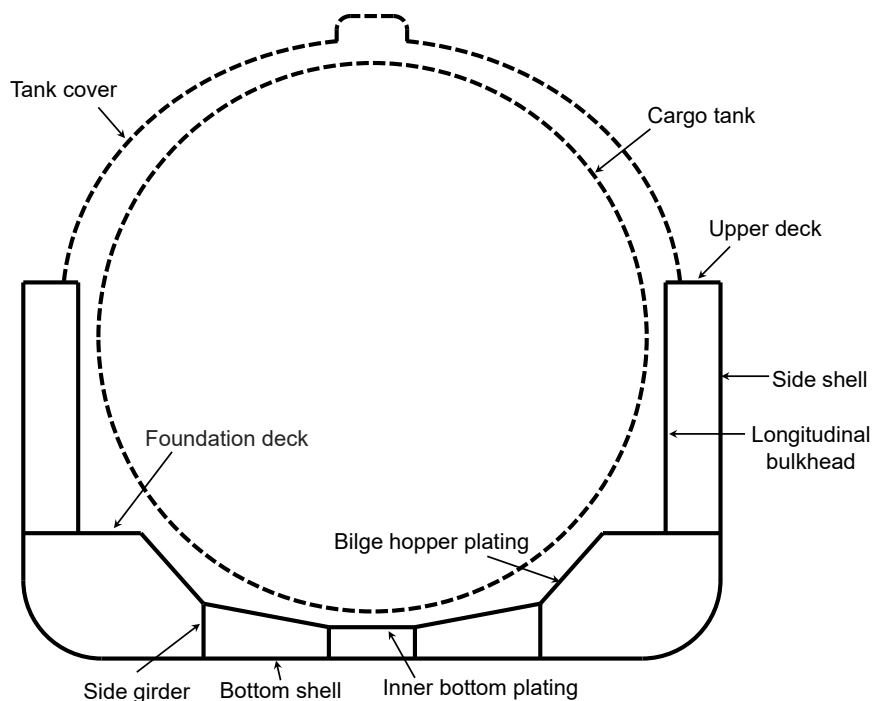

Chapter 3 STRUCTURAL DESIGN PRINCIPLES

3.1 Loading Manual and Loading Instrument

3.1.1 Loading Manual

3.1.1.1 Additional Requirements for the Loading Manual

In applying 3.8.2.1-3, Part 1, the loading manual is to include the following items as operational limitations.

- (1) Where, of the loading conditions considered in the strength assessment by the cargo hold analysis specified in Chapter 8, one cargo tank is empty (one-tank-empty condition) and strength assessment is performed with ballast tanks adjacent to the empty cargo tank as fully loaded, the ballast tanks are to be fully loaded under the loading conditions in the loading manual that corresponds to the one-tank-empty condition.
- (2) Of the loading conditions corresponding to the one-tank-empty conditions considered for the strength assessment by the cargo hold analysis specified in Chapter 8, the designed maximum and minimum draught values specified by the designer.
- (3) Where designing assuming one and/or a few the cargo tanks be empty, the designed position of the empty cargo tanks and its combinations, etc.

Chapter 4 LOADS

4.1 General

4.1.1 Overview

4.1.1.1 Structure and Overview of this Chapter

Each section of this Chapter specifies the additional requirements shown in **Table 4.1.1-1** as the loads used for each formula and each strength assessment to determine the scantlings specified in each Chapter of **Part 2-8** and **Part 1**.

Table 4.1.1-1 Overview of Chapter 4

Section	Title	Overview
4.1	General	Requirements for the general principles of Chapter 4
4.2	Loads to be Considered in Local Strength	Additional requirements for loads to be considered in the requirements of local strength specified in Chapter 6, Part 1 .
4.3	Loads to be Considered in Strength Assessment by Cargo Hold Analysis	Additional requirements for loads to be considered in the requirements for strength assessment by cargo hold analysis specified in Chapter 8 and Chapter 8, Part 1 .
4.4	Loads to be Considered in Fatigue	Additional requirements for loads to be considered in the requirements of fatigue strength assessment specified in Chapter 9 and Chapter 9, Part 1 .

4.2 Loads to be Considered in Local Strength

4.2.1 General

4.2.1.1 General

1 The loads to be considered in the requirements of local strength specified in **Chapter 6, Part 1** are also to be in accordance with the requirements of **4.2**.

2 Additional requirements for loads in the maximum load conditions are to be in accordance with the requirements of **4.2.2**.

4.2.2 Maximum Load Condition

4.2.2.1 Lateral Loads

In applying **4.4.2, Part 1**, the parameters (GM , z_G etc.) required to calculate the dynamic pressure due to ballast water are to be the values in the ballast condition. The same parameters are to be applied where the dynamic pressure due to liquid other than ballast water, such as the pressure due to fuel oil tank, is calculated.

4.3 Loads to be Considered in Strength Assessment by Cargo Hold Analysis

4.3.1 General

4.3.1.1 General

1 The loads to be considered for the strength assessment by the cargo hold analysis specified in **Chapter 8** and **Chapter 8, Part 1** are also to be in accordance with the requirements of **4.3**.

2 Additional requirements for loads in maximum load condition are to be in accordance with the requirements of **4.3.2**.

3 Additional requirements for loads in harbour condition are to be in accordance with the requirements of **4.3.3**.

4.3.2 Maximum Load Condition

4.3.2.1 Loading Conditions

1 Loading conditions which affect structural response of each structure to be assessed significantly are to be considered appropriately from all possible loading conditions except those restricted in the loading manuals.

2 The loading conditions to be considered are to be in accordance with the following (1) to (3). However, where restricting the loading conditions during voyage in the loading manual, the corresponding loading conditions may not be considered.

(1) For cargo hold analysis in the midship part, the loading conditions are to be in accordance with [Table 4.3.2-1](#).

(2) For cargo hold analysis of the aftmost cargo hold, the loading conditions are to be in accordance with [Table 4.3.2-2](#).

(3) For cargo hold analysis of the foremost cargo hold, the loading conditions are to be in accordance with [Table 4.3.2-3](#).

3 The ballast tanks adjacent to the empty cargo hold in the one-tank-empty condition (See S2 in [Table 4.3.2-1](#), [Table 4.3.2-2](#) and [Table 4.3.2-3](#)) are to be taken as being empty where the ballast tanks are designed as being partially loaded or empty and are to be taken as being fully loaded where the ballast tanks are designed as being fully loaded. Where the ballast tanks are taken as being fully loaded, it is to be stated in the loading manual that the ballast tanks are to be fully loaded in loading conditions where one cargo tank is in the one-tank-empty condition.

Table 4.3.2-1 Loading Condition in Maximum Load Condition (Cargo Hold in the Midship Part)

Loading condition	Loading pattern		Draught	Vertical still water bending moment $M_{SV}^{(2)}$	Equivalent design wave
Full load condition	S1		T_{SC}	$M_{SV,max}$	HM-2 / FM-2
				$M_{SV,min}$	HM-1 / FM-1 BR-1P / -1S BP-1P / -1S
Condition loaded/unloaded in multiple ports ⁽¹⁾	S2		T_e	$M_{SV,max}$	HM-2 / FM-2
				$M_{SV,min}$	HM-1 / FM-1 BR-1P / -1S BP-1P / -1S
	S3		T_e	$M_{SV,max}$	HM-2 / FM-2
				$M_{SV,min}$	HM-1 / FM-1 BR-1P / -1S BP-1P / -1S
S4		T_e	$M_{SV,max}$	HM-2 / FM-2	
			$M_{SV,min}$	HM-1 / FM-1 BR-1P / -1S BP-1P / -1S	
Ballast condition	S5		T_{BAL2}	$M_{SV,max}$	HM-2 / FM-2
				$M_{SV,min}$	HM-1 / FM-1 BR-1P / -1S BP-1P / -1S
■: Liquid cargo ▨: Ballast water ▩: Ballast water (See 4.3.2.1-3)					
Notes:					
T_e : Maximum draught (m) in condition loaded/unloaded in multi ports					
T_{BAL2} : Maximum draught (m) in ballast condition					
(1) The radius of gyration (m) around the X-axis is taken as 0.38B. However, the value calculated based on the weight distribution according to the loading condition to be considered may be used.					
(2) In the loading condition to be considered, instead of the vertical still water bending moment specified in the table, the maximum or maximum vertical still water bending moment that occurs after considering all possible physical combinations such as fully filled or empty consumable tank may be used.					

Table 4.3.2-2 Loading Conditions in Maximum Load Condition (Aftmost Cargo Hold)

Loading condition	Loading pattern		Draught	Vertical still water bending moment $M_{SV}^{(2)}$	Equivalent design wave
Full load condition	S1		T_{SC}	M_{SV_max}	HM-2 / FM-2
				M_{SV_min}	HM-1 / FM-1 BR-1P / -1S BP-1P / -1S
Condition loaded/unloaded in multiple ports ⁽¹⁾	S2		T_e	M_{SV_max}	HM-2 / FM-2
				M_{SV_min}	HM-1 / FM-1 BR-1P / -1S BP-1P / -1S
Ballast condition	S3		T_{BAL2}	M_{SV_max}	HM-2 / FM-2
				M_{SV_min}	HM-1 / FM-1 BR-1P / -1S BP-1P / -1S
■, ▨, ▩: As specified in Table 4.3.2-1 .					
Notes:					
T_e , T_{BAL2} : As specified in Table 4.3.2-1					
(1) The radius of gyration (m) around the X -axis is taken as $0.38B$. However, the value calculated based on the weight distribution according to the loading condition to be considered may be used.					
(2) In the loading condition to be considered, instead of the vertical still water bending moment specified in the table, the maximum or maximum vertical still water bending moment that occurs after considering all possible physical combinations such as fully filled or empty consumable tank may be used.					

Table 4.3.2-3 Loading Conditions in Maximum Load Conditions (Foremost Cargo Hold)

Loading condition	Loading pattern		Draught	Vertical still water bending moment $M_{SV}^{(2)}$	Equivalent design wave
Full load condition	S1		T_{SC}	M_{SV_max}	HM-2 / FM-2
				M_{SV_min}	HM-1 / FM-1 BR-1P / -1S BP-1P / -1S
Condition loaded/unloaded in multiple ports ⁽¹⁾	S2		T_e	M_{SV_max}	HM-2 / FM-2
				M_{SV_min}	HM-1 / FM-1 BR-1P / -1S BP-1P / -1S
Ballast condition	S3		T_{BAL2}	M_{SV_max}	HM-2 / FM-2
				M_{SV_min}	HM-1 / FM-1 BR-1P / -1S BP-1P / -1S
■, ▨, ▩: As specified in Table 4.3.2-1 .					
Notes:					
T_e , T_{BAL2} : As specified in Table 4.3.2-1					

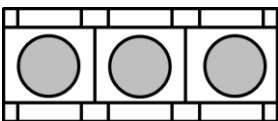
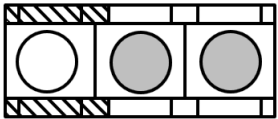
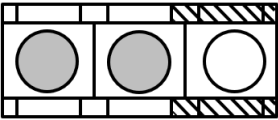
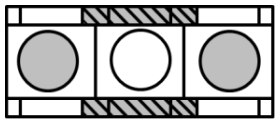
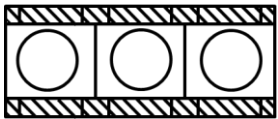
- (1) The radius of gyration (m) around the X -axis is taken as $0.38B$. However, the value calculated based on the weight distribution according to the loading condition to be considered may be used.
- (2) In the loading condition to be considered, instead of the vertical still water bending moment specified in the table, the maximum or maximum vertical still water bending moment that occurs after considering all possible physical combinations such as fully filled or empty consumable tank may be used.

4.3.2.2 Hull Girder Loads

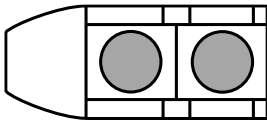
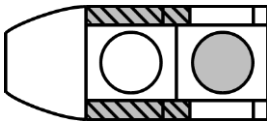
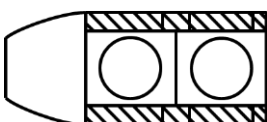
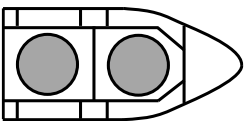
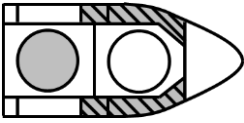
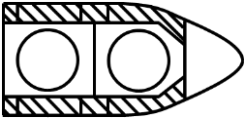
In applying **4.6.2.10, Part 1**, the vertical still water bending moment for the loading condition under consideration is to be in accordance with the requirements of **4.3.2.1**.

4.3.3 Harbour Condition

4.3.3.1 Loading Conditions

In applying the requirements of **4.6.3.1, Part 1**, the loading conditions are to be in accordance with the following (1) to (3). However, where restricting loading conditions in harbour in the loading manual, the corresponding loading conditions may not be considered.

- (1) For the cargo hold analysis in the midship part, the loading conditions are to be in accordance with **Table 4.3.3-1**.
- (2) Cargo hold analysis of the aftmost cargo hold, the loading conditions are to be in accordance with **Table 4.3.2-2**.
- (3) Cargo hold analysis of the foremost cargo hold, the loading conditions are to be in accordance with **Table 4.3.3-3**.

Table 4.3.3-1 Loading Conditions in Harbour Condition (Cargo Hold in the Midship Part)

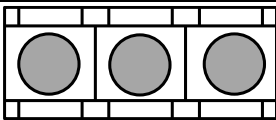
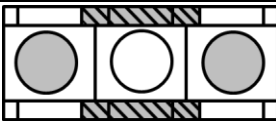
Loading condition	Loading pattern		Draught	Vertical bending moment in harbour
Harbour condition	P1		T_{SC}	M_{PT_max}
				M_{PT_min}
	P2		T_e	M_{PT_max}
				M_{PT_min}



, : As specified in **Table 4.3.2-1**.

Table 4.3.3-2 Loading Conditions in Harbour Condition (Aftmost Cargo Hold)

Loading condition	Loading pattern		Draught	Vertical bending moment in harbour
Harbour condition	P1		T_{SC}	M_{PT_max}
				M_{PT_min}
	P2		T_e	M_{PT_max}
				M_{PT_min}

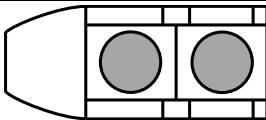
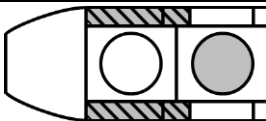

, : As specified in **Table 4.3.2-1**.

Table 4.3.3-3 Loading Conditions in Harbour Condition (Foremost Cargo Hold)

Loading condition	Loading pattern		Draught	Vertical bending moment in harbour
Harbour condition	P1		T_{SC}	M_{PT_max}
				M_{PT_min}
	P2		T_e	M_{PT_max}
				M_{PT_min}
				

4.3.3.2 Hull Girder Loads

In applying 4.6.3.5, Part 1, the vertical bending moment in harbour for the loading condition under consideration is to be in accordance with the requirements of 4.3.3.1.

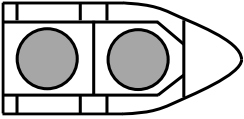
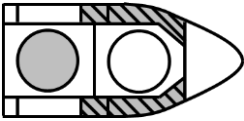
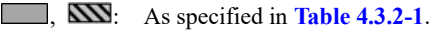
4.4 Loads to be Considered in Fatigue

4.4.1 General

4.4.1.1 General

1 The loads to be considered in the fatigue strength assessment specified in Chapter 9 and Chapter 9, Part 1 are also to be in accordance with the requirements of 4.4.





2 Additional requirements for loads in the cyclic load condition are to be in accordance with the requirements of 4.4.2.

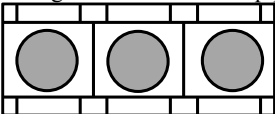
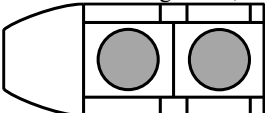
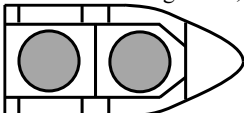

4.4.2 Cyclic Load Condition

4.4.2.1 Loading Conditions

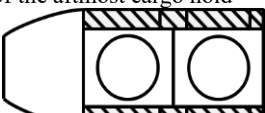
The loading conditions under consideration are to be in accordance with Table 4.4.2-1. Where the difficulty occurs in matching the loading pattern with those specified in Table 4.4.2-1 because of the arrangements of tanks, etc., the pattern based upon the loading condition described in loading manual may be considered.

Table 4.4.2-1 Loading Conditions in Cyclic Load Condition

Loading condition	Loading pattern		Draught	Vertical still water bending moment	Equivalent design wave
Full load condition	FA1	In case of cargo hold in the midship part 	Values at the time of departure described in the loading manual		HM / FM BR / BP
In case of the aftmost cargo hold; 					
In case of the foremost cargo hold; 					
Ballast condition	FA2	In case of cargo hold in the midship part 	Values at the time of departure described in the loading manual		HM / FM BR / BP
In case of the aftmost cargo hold 					
In case of the foremost cargo hold 					

: As specified in [Table 4.3.2-1](#).

4.4.2.2 Hull Girder Loads

In applying [4.7.2.10, Part 1](#), the vertical still water bending moment for the loading condition to be considered is to be in accordance with the requirements of [4.4.2.1](#).

Chapter 5 LONGITUDINAL STRENGTH

5.1 Hull Girder Ultimate Strength

5.1.1 Strength Criteria

5.1.1.1 Effect of Double Bottom Bending

In the assessment decision specified in [5.4.2.2, Part 1](#), the coefficient γ_{DB} that takes into account the effect of double bottom bending is as follows.

$$\gamma_{DB} = 1.25$$

Chapter 7 STRENGTH OF PRIMARY SUPPORTING STRUCTURES

7.1 General

7.1.1 Primary Supporting Structure

7.1.1.1 Members Related to the Primary Support Structure

The scantlings of the members related to the primary support structure are to be determined in accordance with finite element analysis (FEA) based on the requirements of [Chapter 8](#).

Chapter 8 STRENGTH ASSESSMENT BY CARGO HOLD ANALYSIS

8.1 General

8.1.1 Overview

8.1.1.1 Structure and Overview of this Chapter

- 1 This Chapter specifies a method for strength assessment by cargo hold analysis in liquefied gas bulk carriers.
- 2 The structure and overview of this Chapter are shown in [Table 8.1.1-1](#).

Table 8.1.1-1 Overview of Chapter 8

Section	Title	Overview
8.1	General	Additional requirements related to the overview and application of this Chapter
8.2	Evaluation Area and Members to be Assessed	Additional requirements related to evaluation area and members to be assessed
8.3	Structural Models	Additional requirements related to extent of model, members to be modelled, meshing, etc.
8.4	Boundary Conditions and Loads Conditions	Additional requirements related to the boundary conditions and loads conditions

8.1.2 Application

8.1.2.1 Ships to be Assessed

Ships that strength assessment by cargo hold analysis is required, which fall under [8.1.2.1-1\(2\), Part 1](#), are to be ships of which the length of L_C is 90 m or more.

8.2 Evaluation Area and Members to be Assessed

8.2.1 Evaluation Area

8.2.1.1 Evaluation Areas and Target Holds

- 1 In applying [8.2.1.1-2\(1\), Part 1](#), the cargo hold in the midship part is as defined in [Fig. 8.2.1-1](#).
- 2 In applying [8.2.1.1-2\(3\), Part 1](#), the foremost cargo hold and the aftmost cargo hold are to be selected as the target hold. (See [Fig. 8.2.1-1](#))

Fig. 8.2.1-1 Target Hold

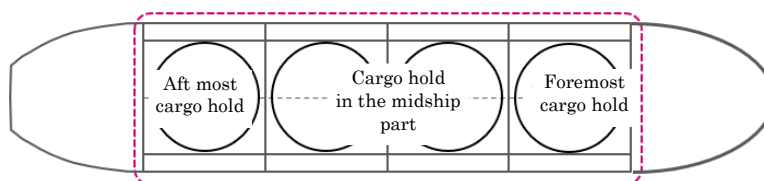

8.2.2 Members to be Assessed

8.2.2.1 Members to be Assessed in Maximum Load Condition, Harbour Condition and Testing Condition

- 1 In applying [8.2.2.1, Part 1](#), the structures and members to be assessed are to be as follows:

- (1) Double bottom structure (bottom shell, inner bottom plating, hopper tank sloping, centre girder, side girder and floor)
 - (2) Double side structure (side shell, longitudinal bulkhead, side stringer and side transverse)
 - (3) Deck structure (including the structure around the cross deck)
 - (4) Bulkhead structure (transverse bulkhead and longitudinal bulkhead)
 - (5) Foundation deck
 - (6) Other members and locations deemed necessary by the Society
- 2 Members forming the cargo tank structure (cargo tank, skirt, tank cover and etc.) are not taken as the members to be assessed.

8.3 Structural Models

8.3.1 General

8.3.1.1 Extent of Model

In applying [8.3.1.1, Part 1](#), the model is, in principle, to represent three adjacent cargo holds with the target hold in the middle and the full depth and the full width of the holds are to be modelled.

8.3.1.2 Properties of Elements

Density of materials is to be adjusted in consideration of the weight of equipment such as unmodeled cargo pumps, piping, etc. and insulation.

8.3.2 Meshing

8.3.2.1 Openings

In principle, openings in the transverse girder in the bilge part are to be modelled by recreating the opening's shape or removing the appropriate elements in consideration of size and position of the opening.

8.4 Boundary Conditions and Loads Conditions

8.4.1 Boundary Conditions

8.4.1.1 Boundary Conditions for the Cargo Hold in the Midship Part

In applying [8.5.1, Part 1](#), where strength assessment are carried out for the cargo hold in the midship part as the target hold, the boundary conditions are to consist of the rigid links at model ends and point constraints (See [Table 8.4.1-1](#)).

Table 8.4.1-1 Boundary Conditions Where Strength Assessment is Carried out for the Cargo Hold in the Midship Part as the Target Hold

Location and node		Translation direction			Rotation direction		
		<i>X</i> direction	<i>Y</i> direction	<i>Z</i> direction	Around <i>X</i> axis	Around <i>Y</i> axis	Around <i>Z</i> axis
Aft end	Independent point	<i>NA</i>	Fix	Fix	Fix	$-M_{V-end}$	$-M_{H-end}$
	Dependent point	Constraint by a rigid link					
Fore end	Independent point	Fix	Fix	Fix	Fix	$+M_{V-end}$	$+M_{V-end}$
	Dependent point	Constraint by a rigid link					
Notes:							
(1) <i>NA</i> means no constraint applied (i.e. free).							
(2) M_{V-end} , M_{H-end} : Adjustment vertical bending moment and adjustment horizontal bending moment, as given in 8.4.2.2 .							

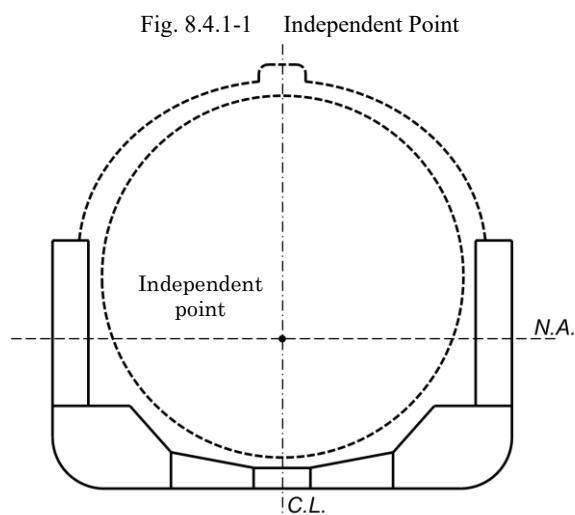

8.4.1.2 Boundary Conditions in Foremost/Aftmost Cargo Hold

In applying 8.5.1, Part 1, the boundary conditions are to consist of the rigid links at model's aft ends and plane constraints where the foremost cargo hold is taken as the target hold, and consist of the rigid links at model's fore ends and plane constraints where the aftmost cargo hold is taken as the target hold (See Tables 8.4.1-2 and 8.4.1-3).

Table 8.4.1-2 Boundary Conditions Where Strength Assessment is Carried out for the Foremost Cargo Hold as the Target Hold

Location and node		Translation direction			Rotation direction		
		X direction	Y direction	Z direction	Around X axis	Around Y axis	Around Z axis
Aft end	Independent point	Fix	Fix	Fix	Fix	Fix	Fix
	Dependent point	Constraint by a rigid link					
Fore end		NA					
Notes: NA means no constraint applied (i.e. free).							

Table 8.4.1-3 Boundary Conditions Where Strength Assessment is Carried out for the Aftmost Cargo Hold as the Target Hold

		Translation direction			Rotation direction		
		X direction	Y direction	Z direction	Around X axis	Around Y axis	Around Z axis
Aft end		NA					
Fore end	Independent point	Fix	Fix	Fix	Fix	Fix	Fix
	Dependent point	Constraint by a rigid link					
Notes: NA means no constraint applied (i.e. free).							

8.4.1.3 Others

In cases where difficulty occurs in appropriately reproducing the hull girder loads and structural response of some members within the target hold, because of being short or long with the length in longitudinal direction of the target hold and the adjacent cargo holds and the reasons other than it, the members may be assessed using boundary conditions different from those specified in 8.4.1.1 and 8.4.1.2.

8.4.2 Loads Condition

8.4.2.1 Loads to be Considered

In applying **8.5.2, Part 1**, loads based also upon the additional requirements specified in **4.3** are to be considered.

8.4.2.2 Method of Applying Loads to the Structural Model

1 In applying **8.5.2, Part 1**, the vertical bending moment and horizontal bending moment act on the target hold are to be adjusted in accordance with the following (1) to (3) based upon the boundary conditions specified in **8.4.1.1** and the value of the moment for each analysis case.

- (1) The maximum and minimum values of the vertical bending moment and horizontal bending moment act on the target hold due to local loads are to be calculated by the following formulae. External pressure, internal pressure and weight of the hull structure, etc., are considered as the local loads

$$M_{V-Max} = \max(M_{V-FEM}(x) | x_{th-a} \leq x \leq x_{th-f})$$

$$M_{V-Min} = \min(M_{V-FEM}(x) | x_{th-a} \leq x \leq x_{th-f})$$

$$M_{H-Max} = \max(M_{H-FEM}(x) | x_{th-a} \leq x \leq x_{th-f})$$

$$M_{H-Min} = \min(M_{H-FEM}(x) | x_{th-a} \leq x \leq x_{th-f})$$

Where:

x_{th-a} , x_{th-f} : X coordinate (m) of the aft and fore ends of the target hold

$M_{V-FEM}(x)$: Vertical bending moment ($kN-m$) due to local loads at any position x , to be taken as follows:

$$M_{V-FEM}(x) = -(x - x_{aft})R_{V-aft} - \sum_i^{x_i < x} (x - x_i)f_{vi}$$

$$M_{H-FEM}(x) = (x - x_{aft})R_{H-aft} + \sum_i (x - x_i)f_{hi}$$

x : X coordinate (m) of position x

x_{aft} , x_{fore} : X coordinate (m) of the aft and fore ends of the structural model

R_{V-fore} , R_{V-aft} , R_{H-fore} , R_{H-aft} : Vertical and horizontal reaction forces (kN) at the support points at the fore and aft ends of the model, to be taken as follows:

$$R_{V-fore} = -\frac{\sum_i (x_i - x_{aft})f_{vi}}{x_{fore} - x_{aft}}$$

$$R_{V-aft} = -\sum_i f_{vi} - R_{V-fore}$$

$$R_{H-fore} = -\frac{\sum_i (x_i - x_{aft})f_{hi}}{x_{fore} - x_{aft}}$$

$$R_{H-aft} = -\sum_i f_{hi} - R_{H-fore}$$

f_{vi} , f_{hi} : Vertical and horizontal components of the local loads at x_i (kN)

x_i : X coordinate (m) of the considered longitudinal station x_i .

- (2) The adjustment vertical bending moment M_{V-end} and adjustment horizontal bending moment M_{H-end} ($kN-m$) are obtained by the following formulae:

$$M_{V-end} = M_{V-targ} - M_{V-max}, \text{ for } M_{V-targ} \geq 0$$

$$M_{V-end} = M_{V-targ} - M_{V-min}, \text{ for } M_{V-targ} < 0$$

$$M_{H-end} = M_{H-targ} - M_{H-max}, \text{ for } M_{H-targ} \geq 0$$

$$M_{H-end} = M_{H-targ} - M_{H-min}, \text{ for } M_{H-targ} < 0$$

M_{V-targ} , M_{H-targ} : The maximum or minimum value in the target hold of the vertical bending moment and horizontal bending moment ($kN-m$) specified in **Table 8.4.2-1**

- (3) The adjustment moments M_{V-end} and M_{H-end} obtained from (2) above are to be applied to the independent points at the fore and aft ends of the model.

Table 8.4.2-1 M_{V-targ} and M_{H-targ}

	Maximum load condition	Harbour condition	Testing condition	Flooded condition
Vertical bending moment M_{V-targ}	M_{V-HG}	M_{PT_max} or M_{PT_min}	0	M_{FD_max} or M_{FD_min}
Horizontal bending moment M_{H-targ}	M_{H-HG}	0	0	0

Notes:

M_{V-HG} , M_{H-HG} : Vertical bending moment and horizontal bending moment ($kN-m$) in maximum load condition.

M_{PT_max} , M_{PT_min} : Vertical bending moment in harbour ($kN-m$)

M_{FD_max} , M_{FD_min} : Vertical bending moment in flooded condition ($kN-m$)

Fig. 8.4.2-1 Example of Vertical Bending Moment Adjustment

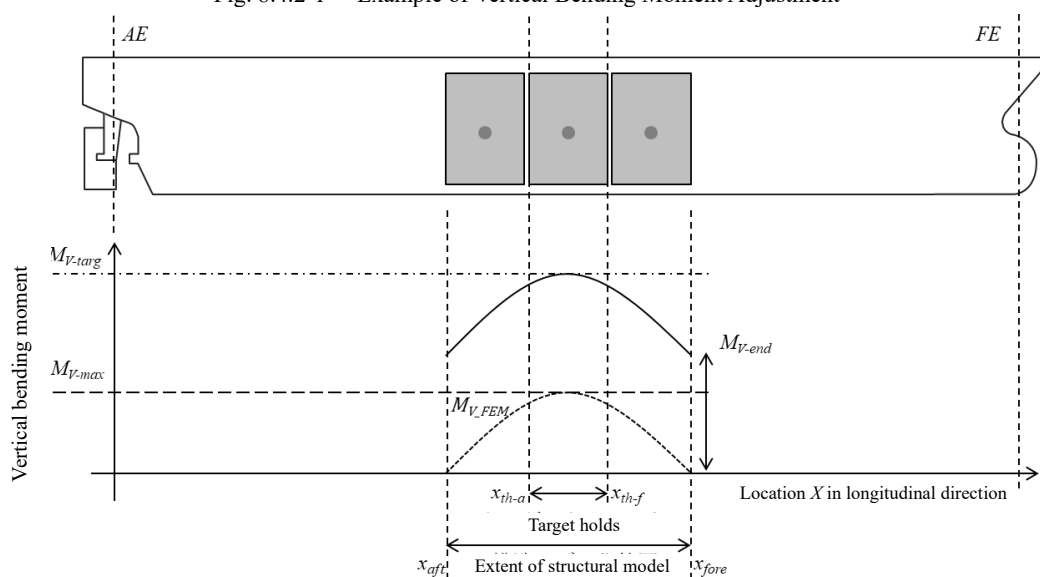

2 Where the foremost or the aftmost cargo hold is selected as the target hold, loads for adjustment are applied near the model's end opposite to the end to which the boundary conditions are applied so that vertical and horizontal bending moment at the middle in the longitudinal direction of the target hold are equal to the value, including the slope of the moment distribution, specified in [Table 8.4.2-1](#). The adjustment loads are, in principle, applied at the cross section where transverse girders are maintained from the baseline to the strength deck.

3 In cases where moments at the cross sections in the target hold exceed those to be considered as the result of applying -1 above, because of being long with the length in longitudinal direction of the target hold and/or significant gap between moments distribution to be considered and those due to local loads and the reasons other than them, the stress caused by the excess moments may be subtracted in accordance with the method as deemed appropriate by the Society. And for the same reasons and etc., where vertical shear force in the target hold exceeds the force specified in [4.3.2, Part 1](#), the effect due to the excess shear force may not be considered.

Chapter 9 FATIGUE

9.1 General

9.1.1 Application of Fatigue Requirements

9.1.1.1 Application

Ships with a length L_C of 90 m or more are to be assessed for fatigue strength based on the hot spot stresses obtained by simplified stress analysis according to **9.3, Part 1** and finite element analysis according to **9.4, Part 1**.

9.2 Structural Details to be Assessed

9.2.1 Structural Details to be Assessed by Finite Element Analysis (FEA)

9.2.1.1

1 Critical structural details to be assessed for fatigue strength by finite element analysis according to **9.4, Part 1**, are shown in **Table 9.2.1-1** and **Table 9.2.1-2**.

2 Notwithstanding the requirements specified in -1 above, where documents demonstrating sufficient fatigue strength are submitted and deemed appropriate by the Society, the fatigue strength assessment of the structure may be omitted.

Table 9.2.1-1 Structural Details of Primary Members to be Assessed in the Hull Structure

No.	Critical structural details of hull structure
1	Intersections of bilge hopper plating and girder or floor (centreline side and inner longitudinal bulkhead side)
2	Intersections of inner longitudinal bulkhead and foundation deck
3	Intersections of tank skirt and foundation deck
4	Intersections of tank cover and upper deck (from centreline to side-most position)
5	Intersections of inner bottom plating and transverse bulkhead (at the centreline)
6	Intersections of slant longitudinal bulkhead and foundation deck
7	Intersections of knuckle part of transverse bulkhead in void space and deck
8	Lower part of transverse web in under deck passage
9	Intersections of knuckle part of inner longitudinal bulkhead in fore and aft cargo holds and their attached plating

Table 9.2.1-2 Specific Structural Details to be Assessed to Continuous Tank Cover

No.	Specific critical structural details to continuous tank cover
10	Intersections of tank cover top and sloping tank cover top
11	Intersections of tank cover top and transverse bulkhead
12	Intersections of tank cover bracket and accommodation space
13	Intersections of tank cover bracket and upper deck
14	Opening of manifold in tank cover
15	Intersections of tank cover top and compressor motor room
16	Opening in pipe dome

9.3 Loading Conditions and Time Ratios to Consider

9.3.1 General

9.3.1.1

- 1 Standard loading conditions and fraction of time are to be in accordance with [Table 9.3.1-1](#).
- 2 Notwithstanding the requirements specified in -1, when considering loading conditions and fraction of time other than those in [Table 9.3.1-1](#), it is necessary to consider appropriate combinations.

Table 9.3.1-1 Standard Loading Conditions and Fraction of Time

Loading conditions	Fraction of time $\alpha_{(j)}$
Full load condition (homogeneous loading)	50 %
Ballast condition	50 %

9.4 Boundary Conditions and Load Conditions

9.4.1 Boundary Conditions

9.4.1.1

In applying [9.4.4.1, Part 1](#), the boundary conditions are to be in accordance with [8.4.1](#).

9.4.2 Load Conditions

9.4.2.1 Method of Applying Moments to the Structural Model

In applying [9.4.4.2, Part 1](#), the method of applying moments to the structural model is to be in accordance with [8.4.2.2](#). However, the vertical bending moment and horizontal bending moment ($kN\cdot m$) specified in [Table 9.4.2-1](#) are to be used as M_{V-targ} , M_{H-targ} instead of that specified in [Table 8.4.2-1](#).

Table 9.4.2-1 M_{V-targ} and M_{H-targ}

	Cyclic load condition
Vertical bending moment M_{V-targ}	M_{V-HG}
Horizontal bending moment M_{H-targ}	M_{H-HG}
Note: M_{V-HG} , M_{H-HG} : Vertical bending moment and horizontal bending moment ($kN\cdot m$) under cyclic load condition, to be in accordance with 4.7.2.10, Part 1 .	

Part 2-9 SHIPS CARRYING LIQUEFIED GASES IN BULK (INDEPENDENT PRISMATIC TANKS TYPE A/B)

Chapter 1 GENERAL

1.1 General

1.1.1 Application

1.1.1.1 Application of this Part

1 The hull construction and equipment of ships intended to be registered as ships with independent prismatic tanks of type A or type B carrying liquefied gases in bulk, affixed with the notation “*Independent Prismatic Tanks of Type A*” (abbreviated as *IPT Type A*) or “*Independent Prismatic Tanks of Type B*” (abbreviated as *IPT Type B*), are to be in accordance with the requirements in **Part 2-9** in addition to **Part 1**.

2 The requirements in **Part 2-9** are for ships described in the following (1) and (2).

(1) LPG carriers

Generally, ships of single side skin constructions having double bottoms, bilge hopper tanks and topside tanks, and that support independent prismatic tanks in the cargo hold by vertical, transverse and longitudinal direction.

(2) LNG carriers

Generally, ships of double side skin constructions having double bottoms and bilge hopper tanks, and that support independent prismatic tanks in the cargo hold by vertical, transverse and longitudinal direction.

3 Ships with independent prismatic tanks carrying liquefied gases in bulk with a different construction from that specified in -2 above, to which the requirements in this Part are considered to be not applicable, are to be at the discretion of the Society.

1.1.1.2 Relationship with Other Rules of the Society*

In applying **1.2.2.5, Part 1**, the relevant requirements specified in **Part N** are shown for the reference.

Table 1.1.1-1 Relationship with the Other Rules

Tank type and hull structure	Items	Relevant rules, etc. other than Part C
Tank type A, B (hull structure)	Applications of steels	4.19.1, Part N and Chapter 6, Part N
Tank type B (Cargo tank structures)	Local strength evaluation ⁽¹⁾	4.21.3, Part N
	Buckling strength evaluation	4.22.3-2, Part N
	Fatigue strength evaluation of tank internal component	4.22.4, Part N
	Evaluation of crack propagation of tank internal component	4.22.4, Part N
	Fatigue strength evaluation of primary members of supports (at the side of cargo tank)	4.22.4, Part N
	Design for small leak protection system (amount of cargo leak, evaluation of evaporation capacity)	4.4.3, Part N

	of secondary barriers, etc.)	
	Vibration analysis	4.13.5, Part N
Tank type A, B (Cargo tank structures)	Sloshing evaluation (within allowable filling levels)	4.14.3, Part N
	Thermal stress analysis (considering transient condition for cargo temperature below -55°C)	4.13.4, Part N
Notes:		
(1) Local strength evaluation of tank type A is to be in accordance with this Chapter 6 .		

1.2 Definitions

1.2.1 Terms

1.2.1.1 Definition of Terms

1 Independent tank type A are tanks primarily designed using classical ship-structural analysis procedures in accordance with recognized standards.

2 Independent tank type B are tanks designed using model tests, refined analytical tools and analysis methods to determine stress levels, fatigue life and crack propagation characteristics.

3 Gap effect means the increment of reaction force on supports caused by allowable construction tolerances taken into consideration during installation of cargo tanks.

1.2.2 Naming Convention

1.2.2.1 Structural Nomenclature

1 [Fig. 1.2.2-1](#) show the common structural nomenclature used in [Part 2-9](#).

2 Supports in [Part 2-9](#) means supports in vertical direction (bottom supports), supports in transverse direction (anti-rolling chocks), supports in longitudinal direction (anti-pitching chocks) and anti-floatation arrangements (anti-floatation chocks). [Fig. 1.2.2-2](#) show the typical structures of various supports.

3 Supporting structures in [Part 2-9](#) include various supports, adjacent hull and cargo tank structures, bearing blocks inserted in the contact surfaces between cargo tanks and various supports and coamings/ dam plates, etc. [Fig. 1.2.2-3](#) show the typical supporting structures.

Fig. 1.2.2-1 Ships Carrying Liquefied Gases in Bulk (Independent Prismatic Tanks)
(Example of midship section of LPG carrier with independent prismatic cargo tanks)

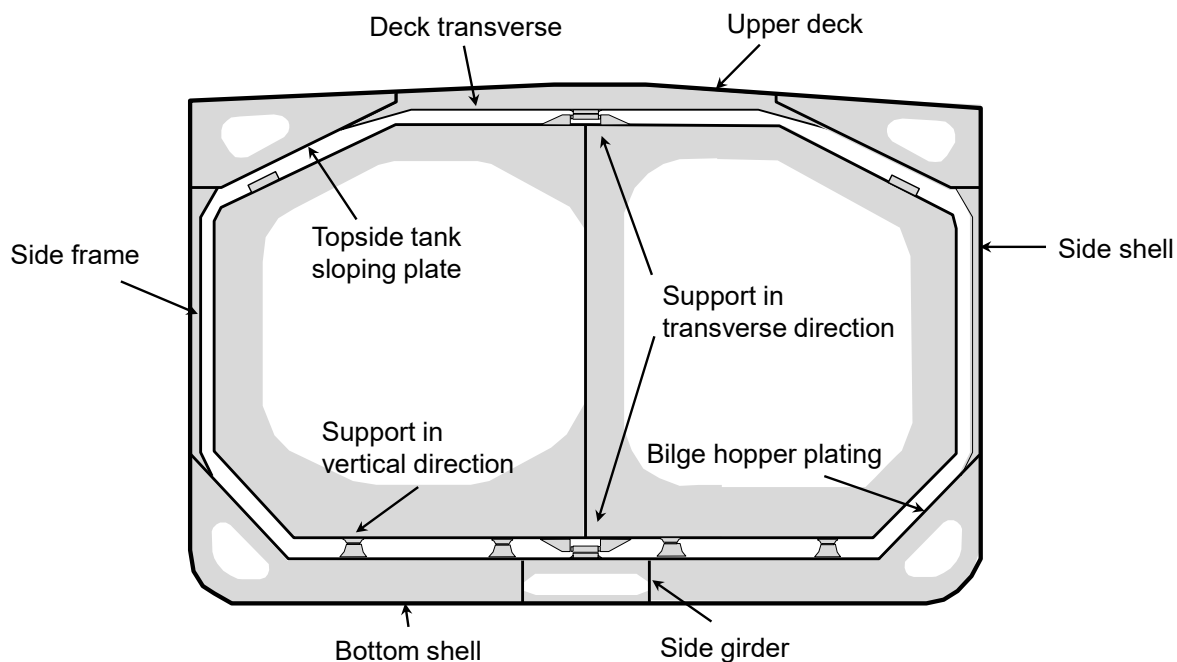
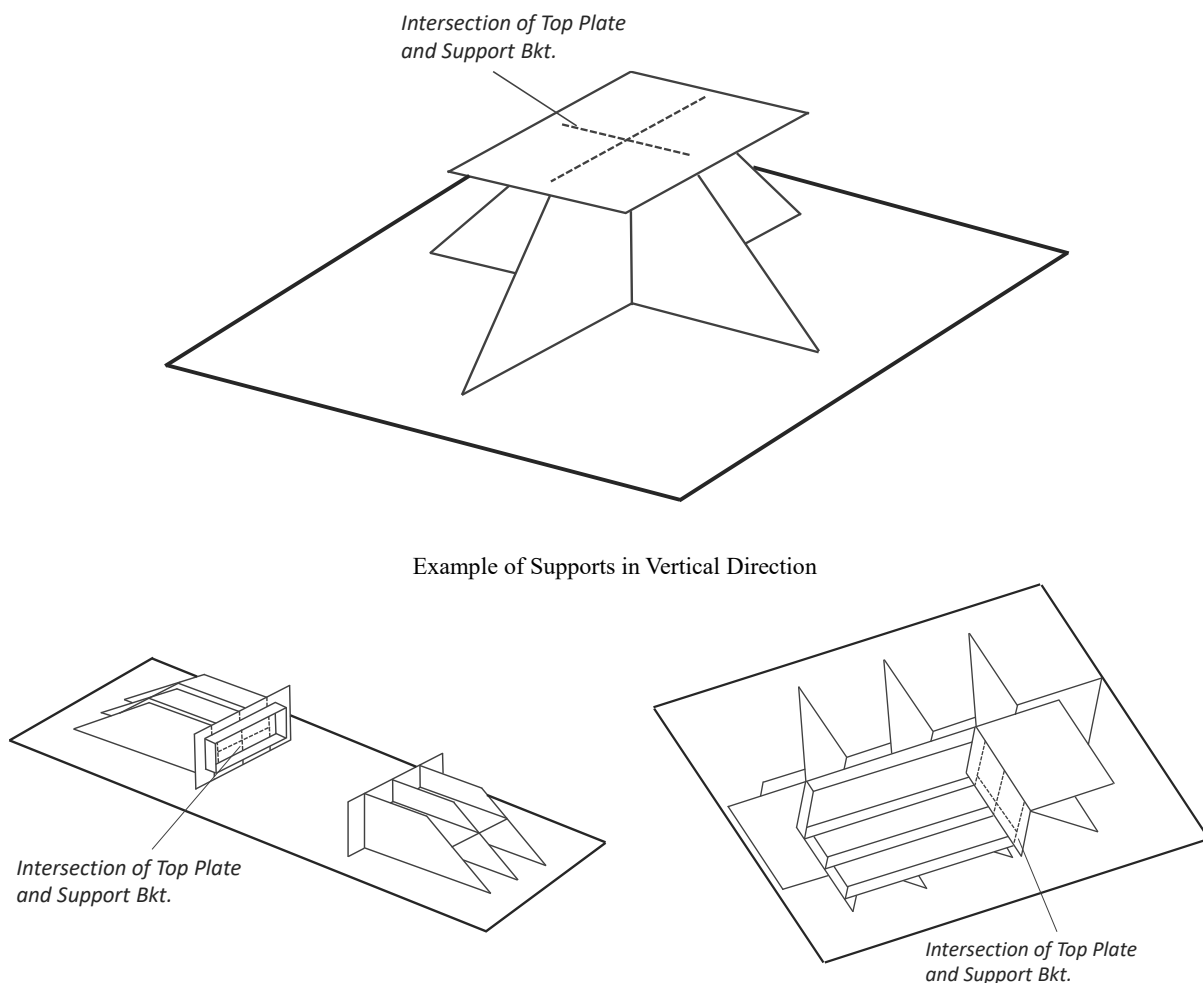
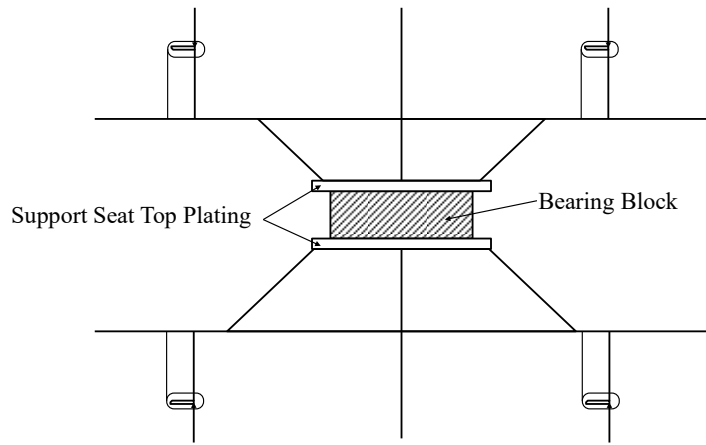

Fig. 1.2.2-2 Various Supports (Examples of Supports in Vertical, Transverse, and Longitudinal Direction)



Example of Supports in Transverse Directions (anti-rolling chock) and Longitudinal Directions (anti-pitching chock)

Fig. 1.2.2-3 Bearing Block, Coaming/Dam Plate and Support Seat Top Plates of Supporting Structures
(Example of Supports in Vertical Direction)



Supporting Structure Example 1

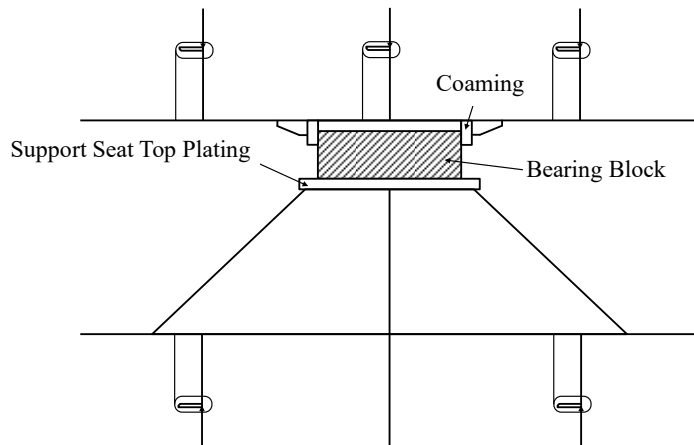

Supporting Structure Example 2

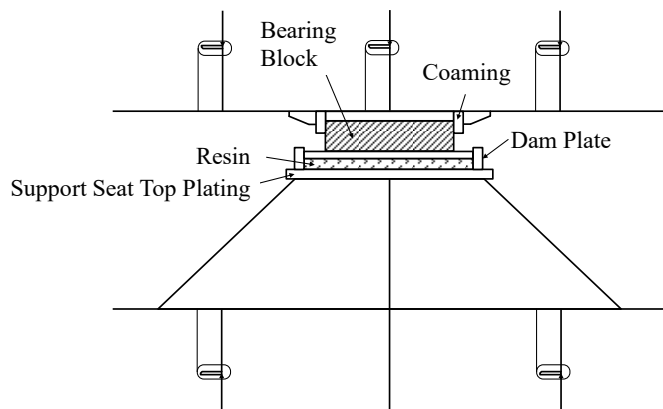

Supporting Structure Example 3

1.3 Plans and Documents to be Submitted

1.3.1 General

1.3.1.1

In the application of **Chapter 8** and **Chapter 9** in this Part, the following documents are to be submitted to the Society:

- (1) Trim, longitudinal strength and stability calculation sheets listing the operational loading conditions (including any limitations related to such loading conditions)
- (2) Documents containing the following information in the application of **Chapter 8**
 - (a) Software used for direct load analysis if applicable
 - (b) Calculation condition and results for direct load analysis if applicable
 - (c) Analytical loading conditions (including parameters such as draught, still water vertical bending moment, etc.)
 - (d) Location of the centre of gravity of each tank
 - (e) Modelling procedures of support structures and method for contact assessments
 - (f) Modelling procedures of cargo tanks including the adjustment necessary to consider the weight of primary fittings such as piping, pumps, insulation materials (e.g. specific gravity adjustments, etc.)
 - (g) Friction coefficients used in analysis (including justification of the use of any values different from standard values in this Part if so adopted)
 - (h) Summary of the reaction and friction forces of the supports derived from finite element analysis for strength assessment by cargo hold analysis
 - (i) Procedures for selection of support structures to be assessed in strength assessment by local structural analysis
 - (j) Permissible construction tolerances to be considered in design (control values for gaps between contact surfaces at supports and procedures to be followed when considering the gap effect in design and permissible work tolerances considered in buckling strength assessments (the latter only applies type B tank)) and documents related to the gap controls for cargo tank installation
 - (k) Summary of the reaction and friction forces derived from finite element analysis for strength assessment by local structural analysis (included documents showing the assessments for design reaction forces due to gap effect to consider any increase in reaction forces for a particular support due to possible relative gap between contact surfaces to be calculated based on the permissible construction tolerances put in place for installing cargo tanks)
- (3) Documents containing the following information in the application of **Chapter 9**
 - (a) Documentation containing information as specified in **(2)(a)** to **(g)** above
 - (b) Procedures for selection of locations for fatigue strength assessment
 - (c) Summary of the reaction and friction forces derived from fatigue strength assessment

Chapter 3 STRUCTURAL DESIGN PRINCIPLES

3.1 Loading Manual and Loading Computer

3.1.1 Loading Manual

3.1.1.1 Additional Requirements for the Loading Manual

In applying **3.8.2.1-3, Part 1**, the loading manual is to include the following items as operational limitations.

- (1) Where, of the loading conditions considered in the strength assessment by the cargo hold analysis specified in **Chapter 8**, one cargo tank is empty (one-tank-empty condition) and strength assessment is performed with ballast tanks adjacent to the empty cargo tank as fully loaded, the ballast tanks are to be fully loaded under the loading conditions in the loading manual that corresponds to the one-tank-empty condition.
- (2) Of the loading conditions corresponding to the one-tank-empty condition considered for the strength assessment by cargo hold analysis specified in **Chapter 8**, the maximum and minimum design draught values specified by the designer.
- (3) Where designing assuming one and/or a few cargo tanks be empty, the designed position of the empty cargo tanks and its combinations, etc.
- (4) Where the cargo tank is not allowed to be loaded asymmetrically port and starboard in the harbour condition, this is to be clearly stated in the loading manual.

Chapter 4 LOADS

4.1 General

4.1.1 Overview

4.1.1.1 Structure and Overview of this Chapter

Each section of this Chapter specifies the additional requirements shown in **Table 4.1.1-1** as the loads used for each formula and each strength assessment to determine the scantlings specified in each chapter of **Part 2-9** and **Part 1**.

Table 4.1.1-1 Overview of Chapter 4

Section	Title	Overview
4.1	General	Requirements for the general principles of Chapter 4
4.2	Loads to be Considered in Local Strength	Additional requirements for loads to be considered for the requirements of local strength specified in Chapter 6 and Chapter 6, Part 1 .
4.3	Loads to be Considered in Strength Assessment by Cargo Hold Analysis	Additional requirements for loads to be considered for the requirements of strength assessment by cargo hold analysis specified in Chapter 8 and Chapter 8, Part 1 .
4.4	Loads to be Considered in Fatigue	Additional requirements for loads to be considered for fatigue strength assessment requirements specified in Chapter 9 and Chapter 9, Part 1 .
Annex 4.3	Relationship Between Operational Loading Conditions and Analytical Loading Conditions	Guidelines on the relationship between the loading conditions to be considered for strength assessment by cargo hold analysis and the loading conditions described in the loading manual

4.1.2 Design Load Scenarios and Loads to be Considered

4.1.2.1

In addition to the requirements of **4.1.2.1, Part 1**, the Design load scenarios and loads in the following (1) to (3) are to be considered in accordance with the requirements of this Chapter:

- (1) 30-degree static heel condition: Lateral loads due to seawater and cargo where the ship is heeled at 30 degrees (Relevant requirements: **4.13.9, Part N**)
- (2) Collision condition: Possible lateral loads due to seawater and cargo in the condition where the ship collides (Relevant requirements: **4.15.1, Part N**)
- (3) Flooded condition (IGC): Loads act on anti-floatation arrangements and support structures of the arrangements where the cargo tank is empty and the cargo hold is flooded up to the summer load line (Relevant requirements: **4.15.2, Part N**)

4.2 Loads to be Considered in Local Strength

4.2.1 General

4.2.1.1 General

1 The loads to be considered for the requirements of local strength specified in **Chapter 6** and **Chapter 6, Part 1** are also to be in accordance with the requirements of **4.2**.

- 2 Additional requirements for loads in maximum load conditions are to be in accordance with the requirements of [4.2.2](#).
- 3 Loads for tank type *A* cargo tanks are to be in accordance with the requirements of [4.2.3](#).

4.2.2 Maximum Load Condition

4.2.2.1 Lateral Loads

1 In applying [4.4.2, Part 1](#), the parameters required to calculate the dynamic pressure due to cargo are to be the values in the loading condition where cargo is loaded in the cargo hold to be considered and the draught is at a minimum (e.g. one-tank-loaded condition). The radius of gyration (m) around *X-axis* is to be taken as $0.38B$, but the value calculated based upon the weight distribution according to the loading condition to be considered may be used.

2 In applying [4.4.2, Part 1](#), the parameters (GM , z_G etc.) required to calculate the dynamic pressure due to ballast water are to be the values in the ballast condition. The same are to be applied where the dynamic pressure due to liquid other than ballast water, such as the pressure due to fuel oil tank, is calculated.

4.2.3 Loads to be Considered in Tank Type A

4.2.3.1 Loads to be Considered in Tank Boundary Plates

The load P_{in} (kN/m^2) to be considered for tank boundary plates is to be in accordance with the following formula. However, P_2 is used only where P_h is set as specified in [4.13.2-3, Part N](#).

$$P_{in} = \max(P_1, P_2, P_3)$$

$$P_1 = P_{ls} + P_{ld}$$

$$P_2 = P_{ls,2}/0.95$$

$$P_3 = P_{heel}$$

P_{ls} : Static pressure and design vapour pressure (kN/m^2), as specified in [4.4.2.4, Part 1](#).

P_{ld} : Dynamic pressure (kN/m^2), in accordance with [4.4.2.4, Part 1](#).

$P_{ls,2}$: Static pressure and design vapour pressure in harbour condition (kN/m^2). As for P_{ls} specified in [4.4.2.4, Part 1](#), it is the value obtained by replacing the design vapour pressure with P_h specified in [4.13.2-3, Part N](#).

P_{heel} : Maximum static pressure in 30-degree static heel condition (kN/m^2)

4.2.3.2 Loads Considering Increase of Pressure due to a Fire

The Load P_f (kN/m^2) considering increase of pressure due to a fire is to be in accordance with the following formula. However, P_{f2} is used only where P_h is set as specified in [4.13.2-3, Part N](#).

$$P_f = \max(P_{f1}, P_{f2})$$

$$P_{f1} = P_{ls,f1} + P_{ld}$$

$$P_{f2} = P_{ls,f2}/0.95$$

$P_{ls,f1}$: Static pressure and design vapour pressure (kN/m^2), as obtained by multiplying the design vapour pressure P_0 by 1.2 in P_{ls} specified in [4.4.2.4, Part 1](#).

P_{ld} : Dynamic pressure (kN/m^2) in accordance with the requirements of [4.4.2.4, Part 1](#).

$P_{ls,f2}$: Static pressure and design vapour pressure in harbour condition (kN/m^2). As for P_{ls} specified in [4.4.2.4, Part 1](#), it is the value obtained by replacing the design vapour pressure with 1.2 times the value of P_h specified in [4.13.2-3, Part N](#).

4.2.3.3 Loads to be Considered in Centreline Bulkheads

The load P_{CL} (kN/m^2) to be consider for centreline bulkheads is to be in accordance with the following formula:

$$P_{CL} = \max(P_{CL1}, P_{CL2}, P_{CL3})$$

$$P_{CL1} = P_{ld}$$

$$P_{CL2} = P_{heel}$$

$$P_{CL3} = P_{ope}$$

P_{ld} : Dynamic pressure (kN/m^2) in accordance with the requirements of [4.4.2.4, Part 1](#).

P_{heel} : Static pressure (kN/m^2) from maximum difference between liquid levels of both sides of the cargo tank in the 30-degree static heel condition.

P_{ope} : Internal pressure (kN/m^2) of cargo tank according to operational restrictions, to be taken as follows. Where operations are limited, operational limitations are to be specified in the loading manual.

Where asymmetric loading of both side of cargo tanks is not allowed in harbour condition, $P_{ope} = 0.4P_{CL1}$

Where asymmetric loading of both side of cargo tanks is allowed in harbour condition, $P_{ope} = P_{ls}/0.95$

Where asymmetric loading of both side of cargo tanks is allowed in maximum load condition, $P_{ope} = P_{ls} + P_{ld}$

4.3 Loads to be Considered in Strength Assessment by Cargo Hold Analysis

4.3.1 General

4.3.1.1 General

1 The loads to be considered in strength assessment by the cargo hold analysis specified in [Chapter 8](#) and [Chapter 8, Part 1](#) are to be in accordance with the requirements of [4.3](#).

2 Additional requirements for loads in the maximum load condition are to be in accordance with the requirements of [4.3.2](#).

3 Additional requirements for loads in the harbour condition are to be in accordance with the requirements of [4.3.3](#).

4 The loads in the 30-degree static heel condition are to be in accordance with the requirements of [4.3.4](#).

5 The loads in the collision condition are to be in accordance with the requirements of [4.3.5](#).

6 The loads in the flooded condition (IGC) are to be in accordance with the requirements of [4.3.6](#).

4.3.2 Maximum Load Condition

4.3.2.1 General

1 As for strength assessment of the cargo tank structure and support structure of tank type B, the loads based on the direct load analysis are to be considered instead of the wave loads specified in [4.3.2](#). The wave loads specified in [4.3.2](#) may be used for the strength assessment of the hull structure; however, since the same structural model as in the assessment of the cargo tank structure is used, it is recommended that the load based on the direct load analysis be considered.

2 In -1 above, “**Guidelines for Direct Load Analysis and Strength Assessment**” is to be applied.

4.3.2.2 Loading Conditions

1 Loading conditions which affect structural response of each structure to be assessed significantly are to be considered appropriately from all possible loading conditions except those restricted in the loading manual.

2 The loading conditions to be considered are to be in accordance with the following (1) to (3). However, where restricting the loading conditions on sea-going in the loading manual, the corresponding loading conditions may not be considered.

(1) For cargo hold analysis in the midship part, the loading conditions are to be in accordance with [Table 4.3.2-1](#).

(2) For cargo hold analysis of the aftmost cargo hold, the loading conditions are to be in accordance with [Table 4.3.2-2](#).

(3) For cargo hold analysis of the foremost cargo hold, the loading conditions are to be in accordance with [Table 4.3.2-3](#).

3 The ballast tanks adjacent to the empty cargo hold in the one-tank-empty condition (*See S2 in [Table 4.3.2-1](#), [Table 4.3.2-2](#) and [Table 4.3.2-3](#)*) are to be taken as being empty where the ballast tanks are designed as being partially loaded or empty and are to be taken as being fully loaded where the ballast tanks are designed as being fully loaded. Where the ballast tanks are taken as being fully loaded, it is to be stated in the loading manual that the ballast tanks are to be fully loaded in loading conditions where one cargo tank is in the one-tank-empty condition.

Table 4.3.2-1 Loading Conditions in Maximum Load Condition (Cargo Hold in the Midship Part)

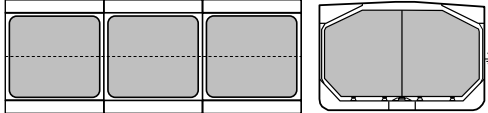
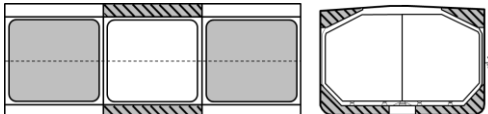
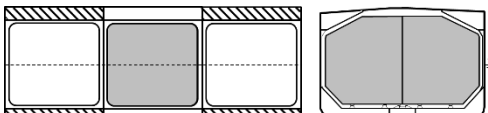
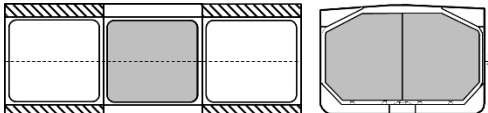
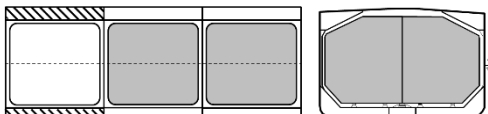
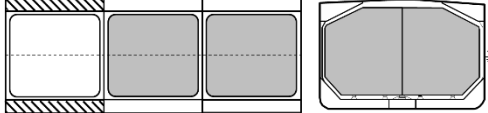
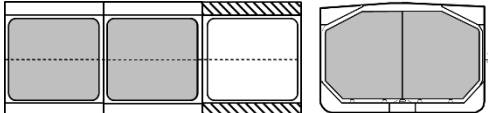
Loading condition	Loading pattern		Draught	Vertical still water bending moment $M_{SV}^{(2)}$	Equivalent design wave
Full load condition	S1		T_{SC}	M_{SV_max}	HM-2 / FM-2 PCL-2
				M_{SV_min}	HM-1 / FM-1 BR-1P / -1S BP-1P / -1S AV-1P / -1S PCL-1
Condition loaded/unloaded in multiple ports ⁽¹⁾	S2		T_{1e_max}	M_{SV_max}	HM-2 / FM-2 PCL-2
	M_{SV_min}	HM-1 / FM-1 BR-1P / -1S BP-1P / -1S PCL-1			
	S3		T_{2e_max}	M_{SV_max}	HM-2 / FM-2 PCL-2
	M_{SV_min}	HM-1 / FM-1 BR-1P / -1S BP-1P / -1S AV-1P / -1S PCL-1			
	S4		T_{2e_min}	M_{SV_max}	HM-2 / FM-2 PCL-2
	M_{SV_min}	HM-1 / FM-1 BR-1P / -1S BP-1P / -1S AV-1P / -1S PCL-1			
	S5		T_{1e_max}	M_{SV_max}	HM-2 / FM-2 PCL-2
M_{SV_min}	HM-1 / FM-1 BR-1P / -1S BP-1P / -1S AV-1P / -1S PCL-1				
S6		T_{1e_min}	M_{SV_max}	HM-2 / FM-2 PCL-2	
M_{SV_min}	HM-1 / FM-1 BR-1P / -1S BP-1P / -1S AV-1P / -1S PCL-1				
S7		T_{1e_max}	M_{SV_max}	HM-2 / FM-2 PCL-2	
M_{SV_min}	HM-1 / FM-1 BR-1P / -1S BP-1P / -1S AV-1P / -1S PCL-1				





Loading condition	Loading pattern		Draught	Vertical still water bending moment $M_{SV}^{(2)}$	Equivalent design wave
	S8		T_{1e_min}	M_{SV_max} M_{SV_min}	HM-2 / FM-2 PCL-2 HM-1 / FM-1 BR-1P / -1S BP-1P / -1S AV-1P / -1S PCL-1
Ballast condition	S9		T_{BAL_max}	M_{SV_max} M_{SV_min}	HM-2 / FM-2 PCL-2 HM-1 / FM-1 BR-1P / -1S BP-1P / -1S PCL-1
<p> : Liquid cargo : Ballast water : Ballast water (See 4.3.2.2-3) </p>					
<p>Notes:</p> <p>T_{1e_max}: Maximum draught designed for loaded/unloaded conditions in multiple ports which is the basis of the one-tank-empty condition (m), and the value are specified by the designer. The value is to be described in the loading manual as an operational restriction.</p> <p>T_{1e_min}: Minimum draught designed for loaded/unloaded conditions in multiple ports which is the basis of the one-tank-empty condition (m), and the value are specified by the designer. The value is to be described in the loading manual as an operational restriction.</p> <p>T_{2e_max}: Maximum draught designed for loaded/unloaded conditions in multiple ports which is the basis of the two-tank-empty condition (m), and the value are specified by the designer.</p> <p>T_{2e_min}: Minimum draught designed for loaded/unloaded conditions in multiple ports which is the basis of the two-tank-empty condition (m), and the value are specified by the designer.</p> <p>T_{BAL_max}: Maximum draught (m) in ballast condition</p>					
<p>(1) The radius of gyration (m) around the X-axis is taken as $0.38B$. However, the value calculated based on the weight distribution according to the loading condition to be considered may be used.</p> <p>(2) In the loading condition to be considered, instead of the vertical still water bending moment specified in the table, the maximum or maximum vertical still water bending moment that occurs after considering all possible physical combinations such as fully filled or empty consumable tank may be used.</p>					

Table 4.3.2-2 Loading Conditions in Maximum Load Condition (Aftmost Cargo Hold)

Loading condition	Loading pattern		Draught	Vertical still water bending moment $M_{SV}^{(2)}$	Equivalent design wave
Full load condition	S1		T_{SC}	$M_{SV_{max}}$	HM-2 / FM-2 PCL-2
				$M_{SV_{min}}$	HM-1 / FM-1 BR-1P / -1S BP-1P / -1S PCL-1
Condition loaded/unloaded in multiple ports ⁽¹⁾	S2		$T_{1e_{max}}$	$M_{SV_{max}}$	HM-2 / FM-2 PCL-2
				$M_{SV_{min}}$	HM-1 / FM-1 BR-1P / -1S BP-1P / -1S PCL-1
	S4		$T_{1e_{min}}$	$M_{SV_{max}}$	HM-2 / FM-2 PCL-2
				$M_{SV_{min}}$	HM-1 / FM-1 BR-1P / -1S BP-1P / -1S PCL-1
Ballast condition	S9		$T_{BAL_{max}}$	$M_{SV_{max}}$	HM-2 / FM-2 PCL-2
				$M_{SV_{min}}$	HM-1 / FM-1 BR-1P / -1S BP-1P / -1S PCL-1

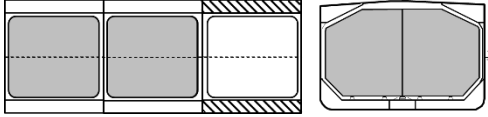
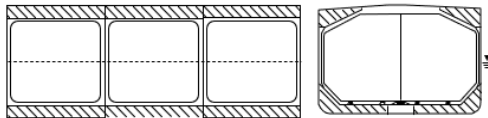
,
 ,
 : As specified in [Table 4.3.2-1](#).

Notes:

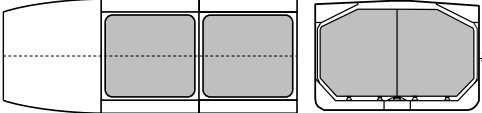
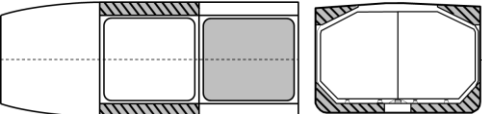
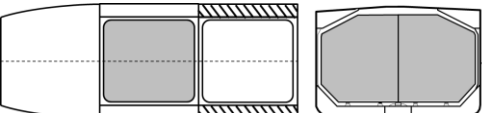
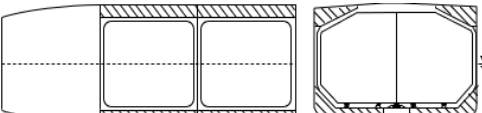
$T_{1e_{max}}$, $T_{BAL_{max}}$: As specified in [Table 4.3.2-1](#).

- (1) The radius of gyration (m) around the X -axis is taken as $0.38B$. However, the value calculated based on the weight distribution according to the loading condition to be considered may be used.
- (2) In the loading condition to be considered, instead of the vertical still water bending moment specified in the table, the maximum or maximum vertical still water bending moment that occurs after considering all possible physical combinations such as fully filled or empty consumable tank may be used.

Table 4.3.2-3 Loading Conditions in Maximum Load Condition (Foremost Cargo Hold)

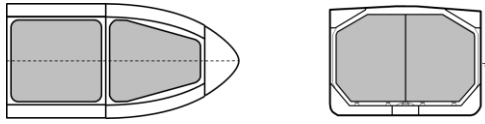
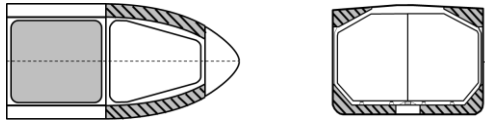
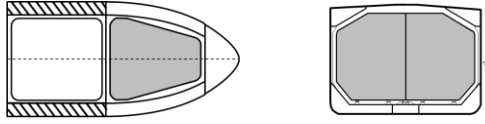
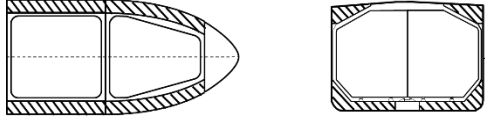
Loading condition	Loading pattern		Draught	Vertical still water bending moment $M_{SV}^{(2)}$	Equivalent design wave
Full load condition	S1		T_{SC}	M_{SV_max}	HM-2 / FM-2 PCL-2
				M_{SV_min}	HM-1 / FM-1 BR-1P / -1S BP-1P / -1S AV-1P / -1S PCL-1
Condition loaded/unloaded in multiple ports ⁽¹⁾	S2		T_{1e_max}	M_{SV_max}	HM-2 / FM-2 PCL-2
				M_{SV_min}	HM-1 / FM-1 BR-1P / -1S BP-1P / -1S PCL-1
	S4		T_{1e_min}	M_{SV_max}	HM-2 / FM-2 PCL-2
				M_{SV_min}	HM-1 / FM-1 BR-1P / -1S BP-1P / -1S AV-1P / -1S PCL-1
Ballast condition	S9		T_{BAL_max}	M_{SV_max}	HM-2 / FM-2 PCL-2
				M_{SV_min}	HM-1 / FM-1 BR-1P / -1S BP-1P / -1S PCL-1

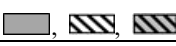
: As specified in [Table 4.3.2-1](#).

Notes:

T_{1e_max} , T_{1e_min} , T_{BAL_max} : As specified in [Table 4.3.2-1](#).

(1) The radius of gyration (m) around the X -axis is taken as $0.38B$. However, the value calculated based on the weight distribution according to the loading condition to be considered may be used.

(2) In the loading condition to be considered, instead of the vertical still water bending moment specified in the table, the maximum or maximum vertical still water bending moment that occurs after considering all possible physical combinations such as fully filled or empty consumable tank may be used.

4.3.2.3 Wave Conditions

Loads based on the equivalent design waves specified in [Table 4.3.2-4](#) are to be additionally considered.

Table 4.3.2-4 Concept of Equivalent Design Wave

Equivalent design wave		Heading	Typical Features	
<i>AV</i> ⁽¹⁾	<i>AV-1P</i>	Oblique sea	Port side: weather side up	Vertical acceleration at the centre of gravity of the cargo hold is maximum
	<i>AV-2P</i>	Oblique sea	Port side: weather side down	Vertical acceleration at the centre of gravity of the cargo hold is minimum
	<i>AV-1S</i>	Oblique sea	Starboard: weather side up	Vertical acceleration at the centre of gravity of the cargo hold is maximum
	<i>AV-2S</i>	Oblique sea	Starboard : weather side down	Vertical acceleration at the centre of gravity of the cargo hold is minimum
<i>PCL</i>	<i>PCL-1</i>	Head sea	Sagging condition	Hydrodynamic pressure at the centre line of the bottom is minimum
	<i>PCL-2</i>	Head sea	Hogging condition	Hydrodynamic pressure at the centre line of the bottom is maximum
(1) The wave <i>AV</i> is applied where the position of the centre of gravity of the cargo hold to be assessed is $0.6 < x/L_C$.				

4.3.2.4 External Pressure due to Seawater

In applying 4.6.2.4, Part 1, hydrodynamic pressure P_{exw} specified in (1) to (2) is to be additionally considered.

- (1) Hydrodynamic pressure in the equivalent design wave *AV* is in accordance with Table 4.3.2-5 and Fig. 4.3.2-1.
- (2) Hydrodynamic pressure in the equivalent design wave *PCL* is in accordance with Table 4.3.2-6 and Fig. 4.3.2-2.

Table 4.3.2-5 Hydrodynamic Pressure P_{exw} in Equivalent Design Wave AV

	Hydrodynamic pressure P_{exw} (kN/m^2)		
	$z \leq T_{LC}$	$T_{LC} < z \leq T_{LC} + h_W$	$z > T_{LC} + h_W$
$AV-1P$	$P_{exw} = \max(P_{AV}, \rho g(z - T_{LC}))$	$P_{WL} - \rho g(z - T_{LC})$	0
$AV-2P$	$P_{exw} = \max(-P_{AV}, \rho g(z - T_{LC}))$		
$AV-1S$	$P_{exw} = \max(P_{AV}, \rho g(z - T_{LC}))$		
$AV-2S$	$P_{exw} = \max(-P_{AV}, \rho g(z - T_{LC}))$		

Notes:

P_{AV} : As given by the following formula:
 $P_{AV} = 0.5C_{R_{AV}}C_{NL_{AV}}C_M C_{AV1}H_{S_{AV}}(P_{AV1} + P_{AV2} + P_{AV3} + P_{AV4} + P_{AV5})$
 $C_{R_{AV}}$: Coefficient considering the effect of ship operation, to be taken as 0.85.
 $C_{NL_{AV}}$: Coefficient considering nonlinear effects, to be taken as 0.9.
 C_M : Coefficient for maximum wave height, to be taken as 1.9.
 C_{AV1} : Correction coefficient for regular wave height, as given by the following formula:
 $C_{AV1} = 0.135(L_C C_{W_{LC}})^{0.26}$
 $H_{S_{AV}}$: Significant wave height (m), as given by the following formula but not to be less than 2.0.
 $H_{S_{AV}} = -0.21T_{Z_{AV}}^2 + 5.07T_{Z_{AV}} - 15.7$
 $T_{Z_{AV}}$: Average zero up-crossing wave period (s), as give by the following formula:

$$T_{Z_{AV}} = 0.71 \sqrt{\frac{2\pi\lambda_{AV}}{g}} + 3.0$$

 λ_{AV} : Wavelength (m) in the equivalent design wave under consideration, as given by the following formula:
 $\lambda_{AV} = 6.0 \cdot (0.014L_C + 3.3)\sqrt{T_{LC}}$

P_{AV1} : As given by the following formula:

$$P_{AV1} = \rho g \cdot \exp\left(\frac{2\pi}{\lambda_{AV}}(z - T_{LC})\right) C_{AV2} \cdot \cos(\varepsilon_{AV1} - \varepsilon_{AV2})$$

 C_{AV2} : Coefficient, as specified in **Table 4.3.2-7**.
 ε_{AV1} : The phase of the incident wave, as specified in **Table 4.3.2-7**.
 ε_{AV2} : The phase of Equivalent design wave AV , as given by the following formula:

$$\varepsilon_{AV2} = 10.28\pi \cdot \exp\left(-7.0 \frac{\lambda_{AV}}{L_C}\right)$$

P_{AV2} : As given by the following formulae:
 For equivalent design waves $AV-1P$ and $AV-2P$:
 For $y > 0.0$, $P_{AV2} = \rho g \left\{ 0.6 \sin\left(\frac{2(x - x_G)}{L_C} \pi\right) - [-2.0 \cdot 10^{-5} \cdot (x - x_G) + 2.0 \cdot 10^{-3}](y^2 + z^2) \right\}$
 For $y \leq 0.0$, $P_{AV2} = \rho g \left\{ 0.6 \sin\left(\frac{2(x - x_G)}{L_C} \pi\right) - 1.0 \cdot 10^{-3} \cdot (y^2 + z^2) \right\}$
 For equivalent design waves $AV-1S$ and $AV-2S$:
 For $y > 0.0$, $P_{AV2} = \rho g \left\{ 0.6 \sin\left(\frac{2(x - x_G)}{L_C} \pi\right) - 1.0 \cdot 10^{-3} \cdot (y^2 + z^2) \right\}$
 For $y \leq 0.0$, $P_{AV2} = \rho g \left\{ 0.6 \sin\left(\frac{2(x - x_G)}{L_C} \pi\right) - [-2.0 \cdot 10^{-5} \cdot (x - x_G) + 2.0 \cdot 10^{-3}](y^2 + z^2) \right\}$

P_{AV3} : As given by the following formulae:
 For equivalent design waves $AV-1P$ and $AV-2P$:
 For $y > 0.0$, $P_{AV3} = \rho g \left\{ -0.8 \sin\left(\frac{5(x - x_G)}{3L_C} \pi\right) + [-1.0 \cdot 10^{-5} \cdot (x - x_G) + 2.0 \cdot 10^{-3}](y^2 + z^2) \right\}$
 For $y \leq 0.0$, $P_{AV3} = \rho g \left\{ -0.8 \sin\left(\frac{5(x - x_G)}{3L_C} \pi\right) + 1.0 \cdot 10^{-3} \cdot (y^2 + z^2) \right\}$

For equivalent design waves AV-1S and AV-2S:

$$\text{For } y > 0.0, P_{AV3} = \rho g \left\{ -0.8 \sin \left(\frac{5(x - x_G)}{3L_C} \pi \right) + 1.0 \cdot 10^{-3} \cdot (y^2 + z^2) \right\}$$

$$\text{For } y \leq 0.0, P_{AV3} = \rho g \left\{ -0.8 \sin \left(\frac{5(x - x_G)}{3L_C} \pi \right) + [-1.0 \cdot 10^{-5} \cdot (x - x_G) + 2.0 \cdot 10^{-3}] (y^2 + z^2) \right\}$$

x_G : X coordinate (m) at the centre of gravity of the ship, to be taken as $x_G = (0.36 + 0.2C_{B_LC})L_C$. The value calculated based on the weight distribution corresponding to the loading condition under consideration may be used.

P_{AV4} : As given by the following formula:

$$P_{AV4} = \rho g |R_{3_AV}| \cos(1.78\pi - 0.42\varepsilon_{AV2})$$

R_{3_AV} : As given by the following formula:

$$R_{3_AV} = \frac{\left[0.5 \left(\frac{2\pi}{K_{AV}L_C} \right)^2 - 1.6 \left(\frac{2\pi}{K_{AV}L_C} \right) + 3.2 \right] \left| -\frac{0.82\lambda_{AV}}{\pi L_C} \sin \left(-\frac{\pi C_{W_LC} L_C}{2\lambda_{AV}} \right) \right|}{\left[K_{AV}B \cdot \exp(-2K_{AV}T_{LC}C_{VP_LC}^2) \cdot \frac{2C_{W_LC}}{C_{W_LC} + 1} \right]} + 9.03 \frac{T_{LC}}{L_C} - 0.3$$

K_{AV} : As given by the following formula:

$$K_{AV} = \frac{1}{g} \left(\sqrt{\frac{2\pi g}{\lambda_{AV}}} + 2.57 \frac{2\pi}{\lambda_{AV}} \right)^2$$

P_{AV5} : As given by the following formula:

$$P_{AV5} = -\rho g |R_{5_AV}| (x - x_G) \cdot (-0.95)$$

R_{5_AV} : As given by the following formula:

$$R_{5_AV} = \frac{-0.54(0.33C_{W_LC} - 0.12) \exp \left(-\frac{2\pi}{\lambda_{AV}} T_{LC} C_{VP_LC} \right)}{0.26 \left(\frac{2\pi}{K_{AV}L_C} + 1.0 \right) K_{AV}B \cdot \exp(-2K_{AV}T_{LC}C_{VP_LC}^4) \cdot \frac{C_{W_LC}^{3.65}}{12} L_C}$$

P_{WL} : Hydrodynamic pressure (kN/m^2) at the waterline in the equivalent design wave to be considered, to be taken as:

For $y \geq 0$, the value of P_{exw} at $y = B_{x1}/2$ and $z = T_{LC}$

For $y < 0$, the value of P_{exw} at $y = -B_{x1}/2$ and $z = T_{LC}$

B_{x1} : Moulded breadth (m) at the waterline of the draught in the cross section to be considered.

h_W : Water head (m) equivalent to the pressure at the waterline, as given by the following formula:

$$h_W = \frac{P_{WL}}{\rho g}$$

Fig. 4.3.2-1 Hydrodynamic Pressure Distribution near $0.7L_C$ in the Equivalent Design Wave AV

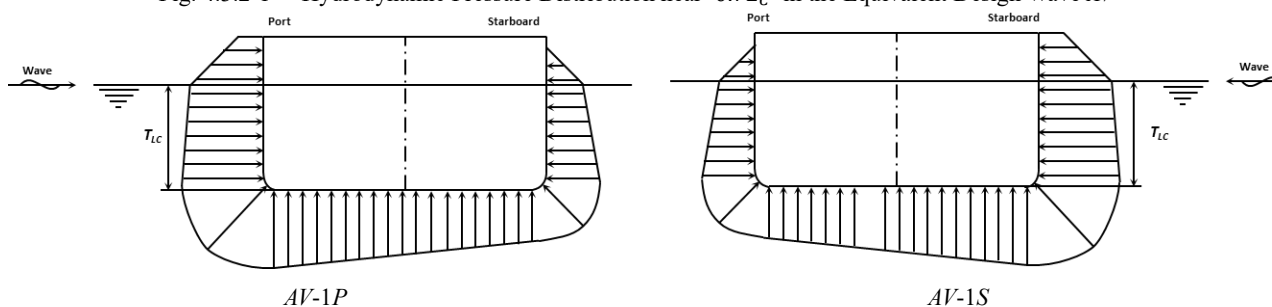

Fig. 4.3.2-2 Hydrodynamic Pressure Distribution near $0.7L_C$ in the Equivalent Design Wave AV

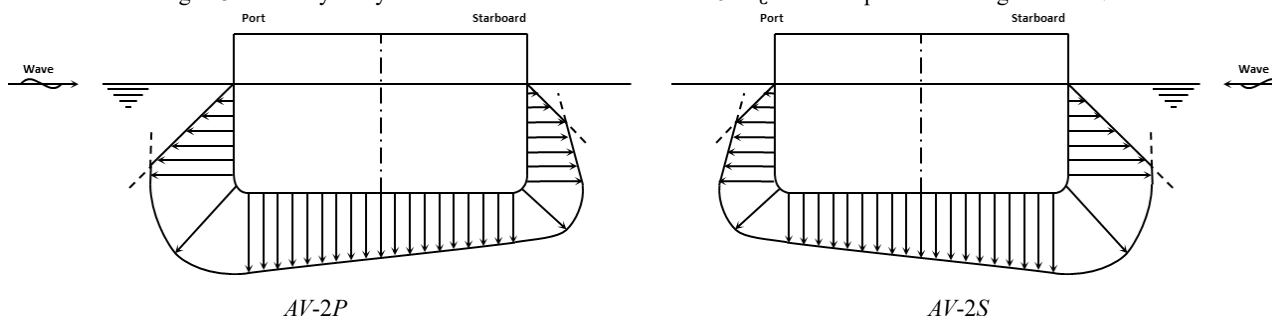

Table 4.3.2-6 Hydrodynamic Pressure P_{exw} in Equivalent Design Wave PCL

	Hydrodynamic pressure P_{exw} (kN/m^2)		
	$z \leq T_{LC}$	$T_{LC} < z \leq T_{LC} + h_W$	$z > T_{LC} + h_W$
$PCL-1$	$P_{exw} = \max(-P_{PCL}, \rho g(z - T_{LC}))$	$P_{WL} - \rho g(z - T_{LC})$	0
$PCL-2$	$P_{exw} = \max(P_{PCL}, \rho g(z - T_{LC}))$		

Notes:

P_{WL} , h_W : As specified in [Table 4.3.2-5](#).

P_{PCL} : As given by the following formula:

$$P_{PCL} = 0.5C_{R_PCL}C_{NL_PCL}C_M C_{PCL1}H_{S_PCL}(P_{PCL1} + P_{PCL2} + P_{PCL3})$$

C_{R_PCL} : Coefficient considering the effect of ship operation, to be taken as 0.85.

C_{NL_PCL} : Coefficient considering nonlinear effect, to be taken as 0.9.

C_M : Coefficient for maximum wave height, to be taken as 1.9.

C_{PCL1} : Correction coefficient for regular wave height, as given by the following formula:

$$C_{PCL1} = -\frac{4.3}{\sqrt{L_C T_{LC}}} + 0.75$$

H_{S_PCL} : Significant wave height (m), as given by the following formula but not to be less than 2.0.

$$H_{S_PCL} = -0.21T_{Z_PCL}^2 + 5.07T_{Z_PCL} - 15.7$$

T_{Z_PCL} : Average zero up-crossing wave period (s), as given by the following formula:

$$T_{Z_PCL} = 0.71 \sqrt{\frac{2\pi\lambda_{PCL}}{g}} + 2.8$$

λ_{PCL} : Wavelength (m) in the equivalent design wave to be considered, as given by the following formula:

$$\lambda_{PCL} = L_C \left(0.6 + \left| 0.3 - \frac{0.8x_{THG}}{L_C} \right| \right)$$

x_{THG} : X coordinate (m) at the centre of gravity of cargo tank in the target hold

P_{PCL1} : As given by the following formula:

$$P_{PCL1} = \rho g \cdot \exp\left(\frac{2\pi}{\lambda_{PCL}}(z - T_{LC})\right) C_{PCL2} \cdot \cos(\varepsilon_{PCL1} - \varepsilon_{PCL2})$$

C_{PCL2} : Coefficient, as specified in [Table 4.3.2-7](#).

ε_{PCL1} : The phase of the incident wave, as specified in [Table 4.3.2-7](#).

ε_{PCL2} : The phase of Equivalent design wave PCL , as given by the following formula:

$$\varepsilon_{PCL2} = \pi \left[1 - \left| \operatorname{sgn}\left(\frac{x_{THG}}{L_C} - 0.5\right) \right| - \operatorname{sgn}\left(\frac{x_{THG}}{L_C} - 0.5\right) \cos\left(1.5\left(\frac{x_{THG}}{L_C} - 0.5\right)\pi\right) \right]$$

P_{PCL2} : As given by the following formula:

$$P_{PCL2} = \rho g |R_{3_PCL}| \cos\left(\left\{ 1.25 \cdot 10^{-3} \cdot L_C + 0.056 \left[\frac{5(T_{SC} - T_{LC})}{T_{SC} - T_{BAL}} + 1 \right] \right\} \pi - \varepsilon_{PCL2}\right)$$

R_{3_PCL} : As given by the following formula:

$$R_{3_PCL} = 2.5 \cdot 10^{-3} \cdot \left[\frac{2(T_{LC} - T_{SC})}{T_{SC} - T_{BAL}} + 1 \right] B + 0.2$$

P_{PCL3} : As given by the following formula:

$$P_{PCL3} = -\rho g |R_{5_PCL}| (x - x_G) \cos\left(\left(0.05\sqrt{\lambda_{PCL}} - 1.28\right)\pi - \varepsilon_{PCL2}\right)$$

R_{5_PCL} : As given by the following formula:

$$R_{5_PCL} = \frac{3\pi(1 - C_{W_LC})}{2B} \left(\frac{\lambda_{PCL}}{L_C}\right)^4$$

x_G : As specified in [Table 4.3.2-5](#).

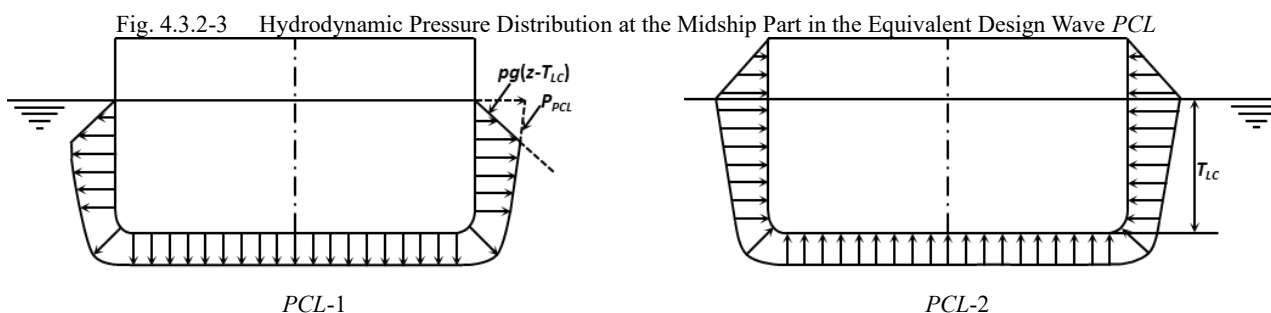

Table 4.3.2-7 Phase of Incident Wave in the Equivalent Design Wave

	$C_{RE} > 0$	$C_{RE} < 0$	$C_{RE} = 0$ and $C_{IM} \geq 0$	$C_{RE} = 0$ and $C_{IM} < 0$
C_{AV2}, C_{PCL2}	1	-1	1	-1
$\varepsilon_{AV1}, \varepsilon_{PCL1}$	$\arctan\left(\frac{C_{IM}}{C_{RE}}\right)$		$\frac{\pi}{2}$	

Notes:

C_{RE} : As given by the following formula:

For equivalent design waves *AV-1P* and *AV-2P*, $C_{RE} = \cos\left(\pi + \frac{2\pi}{\lambda_{AV}}\left[\frac{(x - x_G)}{2} + \frac{\sqrt{3}}{2}y\right]\right)$

For equivalent design waves *AV-1S* and *AV-2S*, $C_{RE} = \cos\left(\pi + \frac{2\pi}{\lambda_{AV}}\left[\frac{(x - x_G)}{2} - \frac{\sqrt{3}}{2}y\right]\right)$

For equivalent design wave *PCL*, $C_{RE} = \cos\left(\pi + \frac{2\pi}{\lambda_{PCL}}(x - x_G)\right)$

λ_{AV} : As specified in [Table 4.3.2-5](#).

λ_{PCL} : As specified in [Table 4.3.2-6](#).

x_G : As specified in [Table 4.3.2-5](#).

C_{IM} : As given by the following formula:

For equivalent design waves *AV-1P* and *AV-2P*, $C_{IM} = \sin\left(\frac{2\pi}{\lambda_{AV}}\left[-\frac{(x - x_G)}{2} - \frac{\sqrt{3}}{2}y\right]\right)$

For equivalent design waves *AV-1S* and *AV-2S*, $C_{IM} = \sin\left(\frac{2\pi}{\lambda_{AV}}\left[-\frac{(x - x_G)}{2} + \frac{\sqrt{3}}{2}y\right]\right)$

For equivalent design wave *PCL*, $C_{IM} = \sin\left(-\frac{2\pi}{\lambda_{PCL}}(x - x_G)\right)$

4.3.2.5 Internal Pressure due to Loaded Liquid

1 In applying [4.6.2.5, Part 1](#), where the cargo tank is equipped with swash bulkhead, it is to be assumed that there is no swash bulkhead when calculating dynamic pressure due to cargo.

2 In applying [4.6.2.5, Part 1](#), the acceleration at any position with respect to the equivalent design wave *AV* and *PCL* is to be in accordance with [Table 4.3.2-8](#).

Table 4.3.2-8 Acceleration at Any Position, a_x , a_y , a_z

Equivalent design wave		Longitudinal acceleration a_x (m/s^2)	Transverse acceleration a_y (m/s^2)	Vertical acceleration a_z (m/s^2)
AV	AV-1P	$-0.5g \cdot \sin \phi$ $+0.1a_1 - 0.95a_5(z - z_G)$	$0.1g \cdot \sin \theta$ $+0.01GMa_2 + 0.1a_4(z - z_G)$ $+[-0.9a_6(x - x_G)]$	$(1.7 \frac{\lambda_{AV}}{L_C} - 0.6)a_3 - 0.1a_4y$ $+0.95a_5(x - x_G)$
	AV-2P	$0.5g \cdot \sin \phi$ $-0.1a_1 + 0.95a_5(z - z_G)$	$-0.1g \cdot \sin \theta$ $-0.01GMa_2 - 0.1a_4(z - z_G)$ $+ [0.9a_6(x - x_G)]$	$(-1.7 \frac{\lambda_{AV}}{L_C} + 0.6)a_3 + 0.1a_4y$ $-0.95a_5(x - x_G)$
	AV-1S	$-0.5g \cdot \sin \phi$ $+0.1a_1 - 0.95a_5(z - z_G)$	$-0.1g \cdot \sin \theta$ $-0.01GMa_2 - 0.1a_4(z - z_G)$ $+ [0.9a_6(x - x_G)]$	$(1.7 \frac{\lambda_{AV}}{L_C} - 0.6)a_3 + 0.1a_4y$ $+0.95a_5(x - x_G)$
	AV-2S	$0.5g \cdot \sin \phi$ $-0.1a_1 + 0.95a_5(z - z_G)$	$0.1g \cdot \sin \theta$ $+0.01GMa_2 + 0.1a_4(z - z_G)$ $+ [-0.9a_6(x - x_G)]$	$(-1.7 \frac{\lambda_{AV}}{L_C} + 0.6)a_3 - 0.1a_4y$ $-0.95a_5(x - x_G)$
PCL	PCL-1	$-0.15 \frac{T_{LC}}{D} \sin \phi - 0.3 \frac{T_{LC}}{D} a_1$ $+ (-40 \frac{f_T}{L_C} - 0.2)a_5(z - z_G)$	0	$15 \frac{f_T}{L_C} a_3$ $- (-40 \frac{f_T}{L_C} - 0.2)a_5(x - x_G)$
	PCL-2	$0.15 \frac{T_{LC}}{D} \sin \phi + 0.3 \frac{T_{LC}}{D} a_1$ $+ (40 \frac{f_T}{L_C} + 0.2)a_5(z - z_G)$	0	$-15 \frac{f_T}{L_C} a_3$ $- (40 \frac{f_T}{L_C} + 0.2)a_5(x - x_G)$
Notes:				
$a_1, a_2, a_3, a_4, a_5, a_6$: As specified in 4.2.3, Part 1 .				
θ, ϕ : As specified in 4.2.2, Part 1 .				
x_G : X coordinate (m) at the centre of gravity of the ship, taken as $x_G = (0.36 + 0.2C_{B,LC})L_C$. However, the value calculated based on the weight distribution according to the loading condition to be considered may be used.				
z_G : Z coordinate (m) at the centre of gravity of the ship in the loading condition to be considered				
GM: Metacentric height (m), the value specified in the loading condition to be considered is to be used.				
λ_{AV} : As specified Table 4.3.2-5 .				

4.3.2.6 Hull Girder Loads

1 In applying **4.6.2.10, Part 1**, the vertical still water bending moment for the loading condition to be considered is to be in accordance with the requirements of **4.3.2.2**.

2 In applying **4.6.2.10, Part 1**, the coefficients C_{4v} and C_{4h} for equivalent design waves AV and PCL are to be in accordance with **Table 4.3.2-9**.

Table 4.3.2-9 Coefficients C_{4v} and C_{4h}

Equivalent design wave		M_{WV-h} or M_{WV-s}		M_{WH}	
		C_{4v}	Condition	C_{4h}	Condition
AV	AV-1P	0.5	Sagging	$1 - 0.9f_T$	Port side (Compression)
	AV-2P		Hogging	$0.9f_T - 1$	Port side (Tension)
	AV-1S		Sagging	$0.9f_T - 1$	Starboard side (Compression)
	AV-2S		Hogging	$1 - 0.9f_T$	Starboard side (Tension)
PCL	PCL-1	0.8	Sagging	0	-
	PCL-2		Hogging		

4.3.3 Harbour Condition

4.3.3.1 Loading Conditions

In applying the requirements of [4.6.3.1, Part 1](#), the loading conditions are to be in accordance with the following (1) to (3). However, when restricting loading conditions in harbour in the loading manual, the corresponding loading conditions may not be considered.

- (1) For the cargo hold analysis in the midship part, the loading conditions are to be in accordance with [Table 4.3.3-1](#).
- (2) Cargo hold analysis of the aftmost cargo hold, the loading conditions are to be in accordance with [Table 4.3.3-2](#).
- (3) Cargo hold analysis of the foremost cargo hold, the loading conditions are to be in accordance with [Table 4.3.3-3](#).

Table 4.3.3-1 Loading Conditions in Harbour Condition (Cargo Hold in the Midship Part)

Loading condition	Loading pattern		Draught	Vertical bending moment in harbour
Harbour condition	P1		T_{SC}	M_{PT_max}
				M_{PT_min}
	P2		T_{P_max}	M_{PT_max}
				M_{PT_min}
	P3		T_{P_min}	M_{PT_max}
M_{PT_min}				
P4		$0.5T_{SC}$	0	
P5		$0.5T_{SC}$	0	

, , : As specified [Table 4.3.2-1](#).

Notes:

Loading condition	Loading pattern	Draught	Vertical bending moment in harbour
$T_{P_{max}}$:	Maximum draught (m) in the conditions where cargo tank is empty in harbour; the value determined by the designer.		
$T_{P_{min}}$:	Minimum draught (m) in the conditions where cargo tank is loaded in harbour; the value determined by the designer.		

Table 4.3.3-2 Loading Conditions in Harbour Condition (Aftmost Cargo Hold)

Loading condition	Loading pattern		Draught	Vertical bending moment in harbour	
Harbour condition	P1		T_{SC}	$M_{PT_{max}}$	
				$M_{PT_{min}}$	
	P2		$T_{P_{max}}$	$M_{PT_{max}}$	
				$M_{PT_{min}}$	
	P3		$T_{P_{min}}$	$M_{PT_{max}}$	
				$M_{PT_{min}}$	
	P4		$0.5T_{SC}$	0	
	P5		$0.5T_{SC}$	0	
	As specified Table 4.3.2-1 .				
	Notes:				
$T_{P_{max}}, T_{P_{min}}$: As specified in Table 4.3.3-1 .					

Table 4.3.3-3 Loading Conditions in Harbour Condition (Foremost Cargo Hold)

Loading condition	Loading pattern		Draught	Vertical bending moment in harbour
P1			T_{SC}	M_{PT_max}
				M_{PT_min}
P2			T_{P_max}	M_{PT_max}
				M_{PT_min}
P3			T_{P_min}	M_{PT_max}
				M_{PT_min}
P4			$0.5T_{SC}$	0
P5			$0.5T_{SC}$	0

, , : As specified [Table 4.3.2-1](#).

Notes:

T_{P_max} , T_{P_min} : See [Table 4.3.3-1](#).

4.3.3.2 Internal Pressure due to Cargo

Where design vapour pressure P_h that exceeds P_0 is given in harbour, in accordance with [4.13.2-3, Part N](#), P_h is to be considered instead of P_0 . However, P_h is to be less than 0.07 MPa.

4.3.3.3 Hull Girder Loads



In applying [4.6.3.5, Part 1](#), the vertical bending moment in harbour for the loading condition under consideration is to be in accordance with the requirements of [4.3.3.1](#).

4.3.4 30-Degree Static Heel Condition

4.3.4.1 Loading Conditions

The standard loading condition is to be in accordance with [Table 4.3.4-1](#).

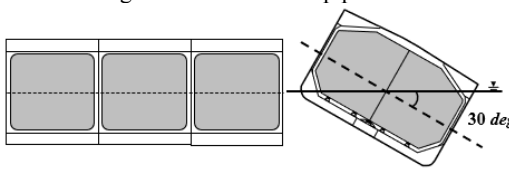
Table 4.3.4-1 Loading Conditions in 30-Degree Static Heel Condition

Loading condition	Loading pattern		Draught	Vertical bending moment
Full load condition	H1	In case of cargo hold in the midship part 	T_{SC}	0
		In cases of the aftmost and foremost cargo holds are to be the same as above.		
 : As specified Table 4.3.2-1 .				
Notes: As for ships whose hull structure and cargo tank structure are asymmetrical, both the port down heel condition and the starboard down heel condition are to be considered.				

4.3.4.2 Wave Conditions

Any wave conditions may not be considered in the 30-degree static heel condition.

4.3.4.3 External Pressure

The external pressure acting on outer shell $P_{ex-HEEL}$ (kN/m^2) is to be given by the following formula. However, it is not to be less than 0.

$$P_{ex-HEEL} = P_{S-HEEL}$$

P_{S-HEEL} : Hydrostatic pressure (kN/m^2), as specified in [Table 4.3.4-2](#).

Table 4.3.4-2 Hydrostatic Pressure in 30-Degree Static Heel Condition

	Hydrostatic pressure P_{S-HEEL} (kN/m^2)
HEEL-1	$\rho g[(T_{SC} - z)\cos\theta_H + y\sin\theta_H]$
HEEL-2	$\rho g[(T_{SC} - z)\cos\theta_H - y\sin\theta_H]$
Notes:	
θ_H :	Roll angle, taken as $\pi/6$

4.3.4.4 Internal Pressure

The internal pressure $P_{in-HEEL}$ (kN/m^2) acting on the cargo tank is to be given by the following formula. However, it is not to be less than 0.

$$P_{in-HEEL} = P_{LS-HEEL}$$

$P_{LS-HEEL}$: Static pressure (kN/m^2), as specified in [Table 4.3.4-3](#).

Table 4.3.4-3 Static Pressure in 30-Degree Static Heel Condition

	Static pressure $P_{LS-HEEL}$ (kN/m^2)
HEEL-1	$\rho_c g[(z_B - z)\cos\theta_H + (y - y_B)\sin\theta_H] + P_0$
HEEL-2	$\rho_c g[(z_B - z)\cos\theta_H - (y - y_B)\sin\theta_H] + P_0$
Notes:	
z_B :	Z coordinate (m) of the tank top position where the ship is heeled
y_B :	Y coordinate (m) of the tank top position where the ship is heeled
θ_H :	As specified in Table 4.3.4-1 .
P_0 :	Design vapour pressure (kN/m^2), not to be less than <i>MARVS</i> specified in 1.1.4, Part N .

4.3.4.5 Weight of Hull Structure

Self-weight of hull structure and cargo tank structure depending on 30-degree heel is to be considered.

4.3.4.6 Hull Girder Loads

The vertical bending moment M_{V-T} ($kN-m$) and horizontal bending moment M_{H-T} ($kN-m$) under consideration in 30 degree static heel condition are to be given by the following formulae:

$$M_{V-T} = 0$$



$$M_{H-T} = 0$$

4.3.5 Collision Condition

4.3.5.1 Loading Conditions

The standard loading condition is to be in accordance with [Table 4.3.5-1](#).

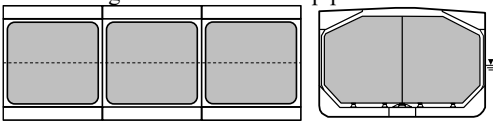
Table 4.3.5-1 Loading Conditions in Collision Condition

Loading condition	Loading pattern		Draught	Vertical bending moment
Full load condition	C1	In case of cargo hold in the midship part 	T_{SC}	0
		In cases of the aftmost and foremost cargo holds are to be the same as above.		
 : As specified in Table 4.3.2-1 .				

4.3.5.2 Wave Conditions

Any wave condition may not be considered in collision condition.

4.3.5.3 External Pressure

The external pressure acting on outer shell P_{ex-COL} (kN/m^2) is to be given by the following formula. However, it is not to be less than 0.

$$P_{ex-COL} = P_{S-COL}$$

P_{S-COL} : Hydrostatic pressure (kN/m^2), as specified in [Table 4.6.2-5, Part 1](#).

4.3.5.4 Internal Pressure

The internal pressure P_{in-COL} due to cargo (kN/m^2) acting on the cargo tank is to be in accordance with the following formula. Dynamic pressure in two conditions that acceleration of $0.5g$ in aft direction and $0.25g$ in forward direction is to be considered. In addition, P_{in-COL} is not to be less than 0.

$$P_{in-COL} = P_{LS-COL} + P_{LD-COL}$$

P_{LS-COL} : Static pressure (kN/m^2), as specified in [Table 4.3.5-2](#).

P_{LD-COL} : Dynamic pressure due to cargo (kN/m^2), as specified in [Table 4.3.5-3](#).

Table 4.3.5-2 Static Pressure in Collision Condition

Static pressure P_{LS-COL}	
$\rho_C g(z_{top} - z) + P_0$	
Notes:	
z_{top} :	The Z-coordinate of the highest point in the cargo tank (m)
P_0 :	Design vapour pressure (kN/m^2), not to be less than <i>MARVS</i> specified in 1.1.5, Part N .

Table 4.3.5-3 Dynamic Pressure due to Cargo in Collision Condition

	Dynamic pressure P_{LD-COL} (kN/m^2)
COL-1	$0.5\rho_c g(x - x_{ae})$
COL-2	$-0.25\rho_c g(x - x_{fe})$
Notes:	
x_{fe} :	X coordinate (m) at the fore end of the cargo tank
x_{ae} :	X coordinate (m) at the aft end of the cargo tank

4.3.5.5 Hull Girder Loads

The vertical bending moment M_{V-T} ($kN-m$) and horizontal bending moment M_{H-T} ($kN-m$) in the collision condition are to be in accordance with the following formulae:

$$M_{V-T} = 0$$



$$M_{H-T} = 0$$

4.3.6 Flooded Condition (IGC)

4.3.6.1 Loading Conditions

The standard loading condition is to be in accordance with [Table 4.3.6-1](#).

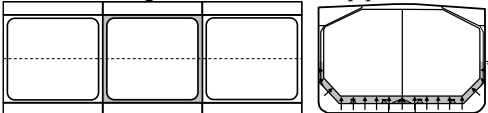
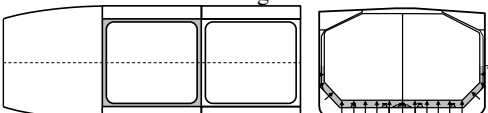
Table 4.3.6-1 Loading Conditions in Flooded Conditions (IGC)

Loading condition	Loading pattern	Draught	Vertical bending moment
-	<p>In case of the cargo hold in the midship part</p>  <p>In the case of the aftmost cargo hold</p>  <p>In the case of the foremost cargo hold</p> 	T_{sum}	0
<p>■: Seawater</p> <p>Notes:</p> <p>T_{sum}: Draught (m), as specified in 4.15.2, Part N.</p>			

4.3.6.2 Wave Conditions

Any wave condition may not be considered in the flooded condition (IGC).

4.3.6.3 External Pressure

The external pressure P_{ex-FD} (kN/m^2) acting on outer shell and cargo tanks is to be in accordance with the following formula. However, it is not to be less than 0.

$$P_{ex-FD} = P_{S-FD}$$

P_{S-FD} : Hydrostatic pressure (kN/m^2), as specified in [Table 4.6.2-5, Part 1](#).

4.3.6.4 Internal Pressure

The internal pressure P_{in-FD} (kN/m^2) acting on the hull due to flooding of the cargo hold is to be in accordance with the following formula. However, it is not to be less than 0.

$$P_{in-FD} = P_{S-FD}$$

P_{S-FD} : Hydrostatic pressure (kN/m^2), as specified in **Table 4.6.2-5, Part 1**.

4.3.6.5 Hull Girder Loads

The vertical bending moment M_{V-T} ($kN-m$) and horizontal bending moment M_{H-T} ($kN-m$) in the flooded condition are to be in accordance with the following formulae:

$$M_{V-T} = 0$$

$$M_{H-T} = 0$$

4.4 Loads to be Considered in Fatigue

4.4.1 General

4.4.1.1 General

1 The loads to be considered in fatigue strength assessment specified in **Chapter 9** and **Chapter 9, Part 1** are to be in accordance with the requirements of **4.4**.

2 Additional requirements for loads in the cyclic load condition are to be in accordance with the requirements of **4.4.2**.

4.4.2 Cyclic Load Condition

4.4.2.1 General

As for strength assessment of the cargo tank structure and support structure of tank type B, the loads based on the direct load analysis are to be considered instead of the wave loads specified in **4.4.2**. The wave loads specified in **4.4.2** may be used for the strength assessment of the hull structure; however, since the same structural model as in the assessment of the cargo tank structure is used, it is recommended that the load based on the direct load analysis be considered.



2 In -1 above, “**Guidelines for Direct Load Analysis and Strength Assessment**” is to be applied.

4.4.2.2 Loading Conditions

In applying **4.7.2.1, Part 1**, the loading conditions specified in **Table 4.4.2-1** are to be considered. Where the difficulty occurs in matching the loading pattern with those specified **Table 4.4.2-1** in because of the arrangement of tanks, etc., the pattern based upon the loading condition described in the loading manual may be considered.

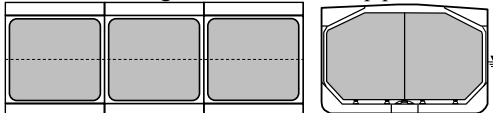
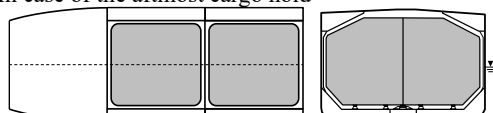
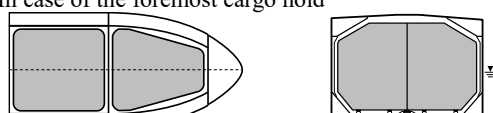
Table 4.4.2-1 Loading Conditions in Cyclic Load Condition

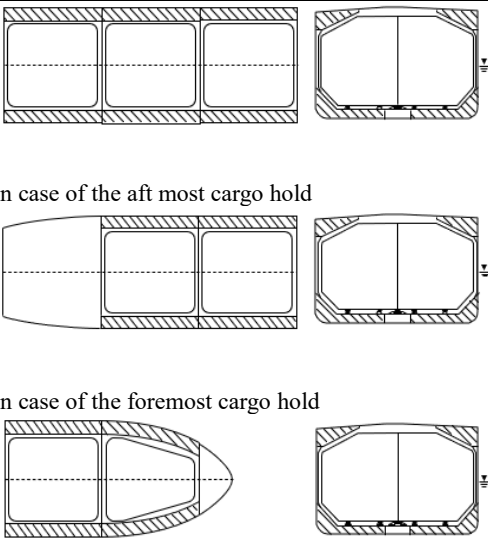
Loading condition	Loading condition	Draught	Vertical still water bending moment	Equivalent design wave
Full load condition	In case of the cargo hold in the midship part 		Values at the time of departure described in the loading manual	<i>HM / FM</i> <i>BR / BP</i> <i>AV / PCL</i>
	In case of the aftmost cargo hold 			
	In case of the foremost cargo hold 			
Ballast condition	<i>FA2</i> In case of the cargo hold in the midship part		Values at the time of departure described in	<i>HM / FM</i> <i>BR / BP</i>

		 <p>In case of the aft most cargo hold</p> <p>In case of the foremost cargo hold</p>	the loading manual	<i>AV / PCL</i>
 : As specified in Table 4.3.2-1 .				

4.4.2.3 Wave Conditions

Loads based on the equivalent design waves specified in [Tables 4.4.2-2](#) are to be additionally considered.

Table 4.4.2-2 Concept of Equivalent Design Wave

Equivalent design wave		Heading	Typical Features	
<i>AV</i> ⁽¹⁾	<i>AV-1P</i>	Oblique sea	Port side: weather side up	Vertical acceleration at the centre of gravity of the cargo hold is maximum
	<i>AV-2P</i>	Oblique sea	Port side: weather side down	Vertical acceleration at the centre of gravity of the cargo hold is minimum
	<i>AV-1S</i>	Oblique sea	Starboard: weather side up	Vertical acceleration at the centre of gravity of the cargo hold is maximum
	<i>AV-2S</i>	Oblique sea	Starboard: weather side down	Vertical acceleration at the centre of gravity of the cargo hold is minimum
<i>PCL</i>	<i>PCL-1</i>	Head sea	Sagging condition	Hydrodynamic pressure at the centre line of the bottom is minimum
	<i>PCL-2</i>	Head sea	Hogging condition	Hydrodynamic pressure at the centre line the bottom is maximum

(1) The wave *AV* is applied where the position of the centre of gravity of the cargo hold to be assessed is $0.6 < x/L_C$.

4.4.2.4 External Pressure due to Seawater

Hydrodynamic pressure P_{exw} specified in (1) to (2) is to be additionally considered.

- (1) Hydrodynamic pressure in the equivalent design wave *AV* is specified in [Table 4.4.2-3](#) and [Fig. 4.4.2-1](#).
- (2) Hydrodynamic pressure in the equivalent design wave *PCL* is specified in [Table 4.4.2-4](#) and [Fig. 4.4.2-2](#).

Fig. 4.4.2-1 Hydrodynamic Pressure Distribution near $0.7L_C$ in the Equivalent Design Wave AV

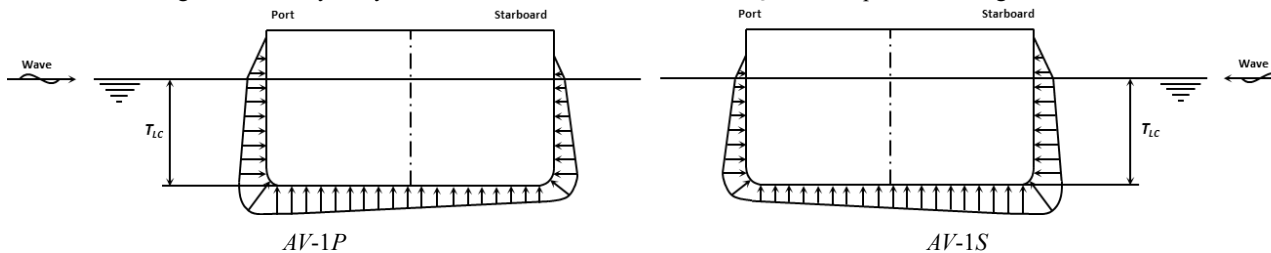

Table 4.4.2-3 Hydrodynamic Pressure P_{exw} in Equivalent Design Wave AV

	Hydrodynamic pressure P_{exw} (kN/m^2)		
	$z \leq T_{LC}$	$T_{LC} < z \leq T_{LC} + 2h_W$	$z > T_{LC} + 2h_W$
$AV-1P$	$P_{exw} = \max(P_{AV}, \rho g(z - T_{LC}))$	$P_{WL} - \frac{1}{2} \rho g(z - T_{LC})$	0
$AV-2P$	$P_{exw} = \max(-P_{AV}, \rho g(z - T_{LC}))$		
$AV-1S$	$P_{exw} = \max(P_{AV}, \rho g(z - T_{LC}))$		
$AV-2S$	$P_{exw} = \max(-P_{AV}, \rho g(z - T_{LC}))$		

Notes:

P_{AV} : As given by the following formula:
 $P_{AV} = 0.5 C_{F_{AV}} C_M C_{AV1} H_{S_{AV}} (P_{AV1} + P_{AV2} + P_{AV3} + P_{AV4} + P_{AV5})$
 $C_{F_{AV}}$: Coefficient for fatigue, to be taken as 0.25.
 $C_M, C_{AV1}, H_{S_{AV}}$: As specified in [Table 4.3.2-5](#).
 $P_{AV1}, P_{AV2}, P_{AV3}, P_{AV4}, P_{AV5}$: As specified in [Table 4.3.2-5](#).

P_{WL} : Hydrodynamic pressure (kN/m^2) at the waterline in the equivalent design wave to be considered, as given by the following formula:
 $P_{WL} = P_{exw}$, for $|y| = B_{x1}/2$ and $z = T_{LC}$
 B_{x1} : Moulded breadth (m) at the waterline of the scantling draught in the cross section under consideration.

h_W : Water head (m) equivalent to the pressure at the waterline, as given by the following formula:
 $h_W = \frac{P_{WL}}{\rho g}$

Fig. 4.4.2-2 Hydrodynamic Pressure Distribution near $0.7L_C$ in the Equivalent Design Wave AV

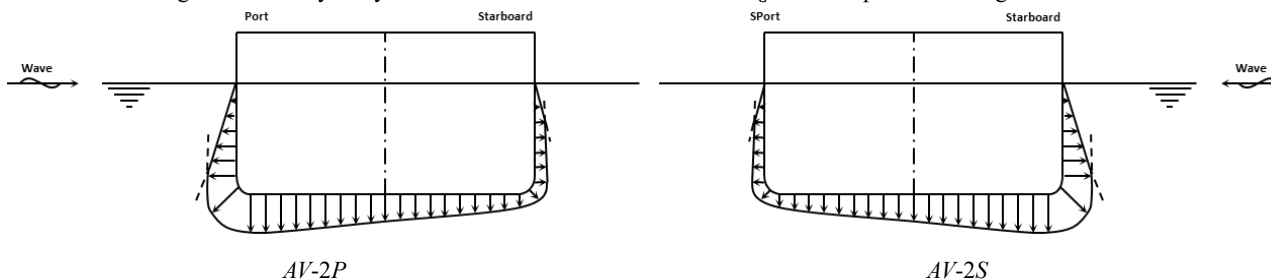

Table 4.4.2-4 Hydrodynamic Pressure P_{exw} in Equivalent Design Wave PCL

	Hydrodynamic pressure P_{exw} (kN/m^2)		
	$z \leq T_{LC}$	$T_{LC} < z \leq T_{LC} + 2h_W$	$z > T_{LC} + 2h_W$
$PCL-1$	$P_{exw} = \max(-P_{HM}, \rho g(z - T_{LC}))$	$P_{WL} - \frac{1}{2} \rho g(z - T_{LC})$	0
$PCL-2$	$P_{exw} = \max(P_{HM}, \rho g(z - T_{LC}))$		

Notes:

P_{WL} , h_W : As specified in [Table 4.4.2-3](#).

P_{PCL} : As given by the following formula:
 $P_{PCL} = 0.5 C_{F_PCL} C_M C_{PCL1} H_{S_PCL} (P_{PCL1} + P_{PCL2} + P_{PCL3})$
 C_{F_PCL} : Coefficient for fatigue, to be taken as 0.25.
 C_M , C_{PCL1} , H_{S_PCL} : As specified in [Table 4.3.2-6](#).
 P_{PCL1} , P_{PCL2} , P_{PCL3} : As specified in [Table 4.3.2-6](#).

Table 4.4.2-3 Hydrodynamic Pressure Distribution in the Midship Part in the Equivalent Design Wave PCL

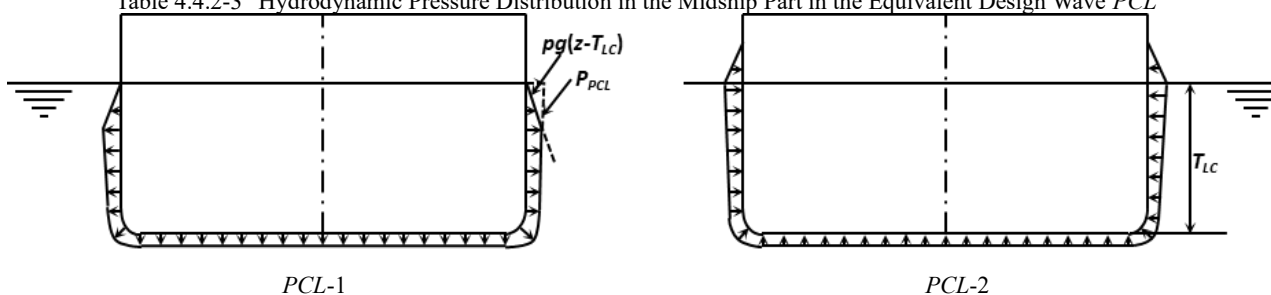

4.4.2.5 Internal Pressure due to Loaded Liquid

In applying [4.7.2.5, Part 1](#), the acceleration at any position with respect to the equivalent design wave AV and PCL is to be in accordance with [Table 4.4.2-5](#).

Table 4.4.2-5 Acceleration at Any Position a_x , a_y , a_z

Equivalent design wave	Longitudinal acceleration a_x (m/s^2)	Transverse acceleration a_y (m/s^2)	Vertical acceleration a_z (m/s^2)	
AV	AV-1P	$-0.5g \cdot \sin \phi$ $+0.1a_1 - 0.95a_5(z - z_G)$	$0.1g \cdot \sin \theta$ $+0.01GMa_2 + 0.1a_4(z - z_G)$ $+[-0.9a_6(x - x_G)]$	$(1.7 \frac{\lambda_{AV}}{L_C} - 0.6)a_3 - 0.1a_4y$ $+0.95a_5(x - x_G)$
	AV-2P	$0.5g \cdot \sin \phi$ $-0.1a_1 + 0.95a_5(z - z_G)$	$-0.1g \cdot \sin \theta$ $-0.01GMa_2 - 0.1a_4(z - z_G)$ $+ [0.9a_6(x - x_G)]$	$(-1.7 \frac{\lambda_{AV}}{L_C} + 0.6)a_3 + 0.1a_4y$ $-0.95a_5(x - x_G)$
	AV-1S	$-0.5g \cdot \sin \phi$ $+0.1a_1 - 0.95a_5(z - z_G)$	$-0.1g \cdot \sin \theta$ $-0.01GMa_2 - 0.1a_4(z - z_G)$ $+ [0.9a_6(x - x_G)]$	$(1.7 \frac{\lambda_{AV}}{L_C} - 0.6)a_3 + 0.1a_4y$ $+0.95a_5(x - x_G)$
	AV-2S	$0.5g \cdot \sin \phi$ $-0.1a_1 + 0.95a_5(z - z_G)$	$0.1g \cdot \sin \theta$ $+0.01GMa_2 + 0.1a_4(z - z_G)$ $+ [-0.9a_6(x - x_G)]$	$(-1.7 \frac{\lambda_{AV}}{L_C} + 0.6)a_3 - 0.1a_4y$ $-0.95a_5(x - x_G)$
PCL	PCL-1	$-0.15 \frac{T_{LC}}{D} \sin \phi - 0.3 \frac{T_{LC}}{D} a_1$ $+ (-40 \frac{f_T}{L_C} - 0.2) a_5(z - z_G)$	0	$15 \frac{f_T}{L_C} a_3$ $- (-40 \frac{f_T}{L_C} - 0.2) a_5(x - x_G)$
	PCL-2	$0.15 \frac{T_{LC}}{D} \sin \phi + 0.3 \frac{T_{LC}}{D} a_1$ $+ (40 \frac{f_T}{L_C} + 0.2) a_5(z - z_G)$	0	$-15 \frac{f_T}{L_C} a_3$ $- (40 \frac{f_T}{L_C} + 0.2) a_5(x - x_G)$
Notes: $a_1, a_2, a_3, a_4, a_5, a_6$: As specified in 4.2.3, Part 1 . θ, ϕ : As specified in 4.2.2, Part 1 . x_G : X coordinate (m) at the centre of gravity of the ship, taken as $x_G = (0.36 + 0.2C_{B,LC})L_C$. However, the value calculated based on the weight distribution according to the loading condition to be considered may be used. z_G : Z coordinate (m) at the centre of gravity of the ship in the loading condition under consideration GM : Metacentric height (m), the value specified in the loading condition under consideration is to be used. λ_{AV} : As specified in Table 4.3.2-5 .				

4.4.2.6 Hull Girder Loads

1 In applying **4.7.2.10, Part 1**, the vertical still water bending moment for the loading condition under consideration is to be in accordance with the requirements of **4.4.2.2**.

2 In applying **4.7.2.10, Part 1**, the coefficients C_{4v} and C_{4h} for equivalent design waves AV and PCL are to be in accordance with **Table 4.4.2-6**.

Table 4.4.2-6 Coefficients C_{4v} and C_{4h}

Equivalent design wave		M_{WV-h} or M_{WV-s}		M_{WH}	
		C_{4v}	Condition	C_{4h}	Condition
<i>AV</i>	<i>AV-1P</i>	0.125	Sagging	$0.25 - 0.225f_T$	Port side (Compression)
	<i>AV-2P</i>		Hogging	$0.225f_T - 0.25$	Port side (Tension)
	<i>AV-1S</i>		Sagging	$0.225f_T - 0.25$	Starboard side (Compression)
	<i>AV-2S</i>		Hogging	$0.25 - 0.225f_T$	Starboard side (Tension)
<i>PCL</i>	<i>PCL-1</i>	0.2	Sagging	0	-
	<i>PCL-2</i>		Hogging		

Annex 4.3 OPERATIONAL LOADING CONDITIONS AND ANALYTICAL LOADING CONDITIONS

An1. General

An1.1 General

An1.1.1

1 The purpose of this Annex is to specify the relationship between the analytical loading condition and operational loading condition for reference purposes.

An2. Operational Loading Condition and Analytical Loading Condition

An2.1 Operational Loading Condition

An2.1.1

1 Operational loading condition refers to “all loading conditions assumed in the design of individual vessels”. This means a combination of loading conditions for each tank in all cargo areas as specified in the loading manual. Such conditions, however, do not include ones that are either directly or indirectly prohibited by the loading manual (i.e. conditions that are substantially restricted by the allowable values for the vertical still water bending moment, allowable values for the vertical still water shear force, draught, etc.).

2 Where evaluating a liquefied gas carrier with four holds, the possible operational loading conditions are shown in **Fig. An1**, except the half-loaded condition of each tank, etc.

Fig. An1 Example of Operational Loading Conditions (Liquefied Gas Carrier with Four Holds)

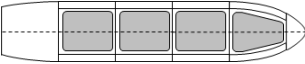
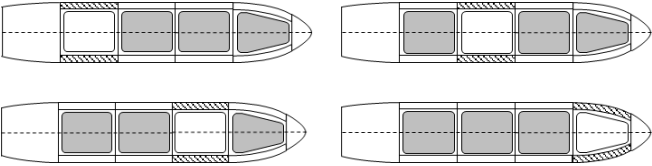
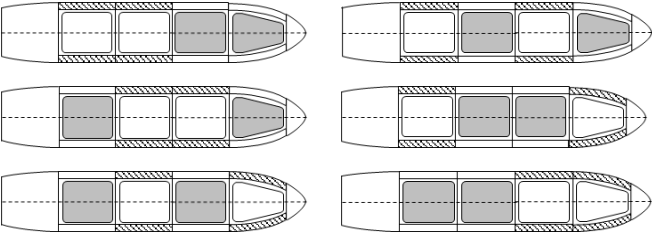
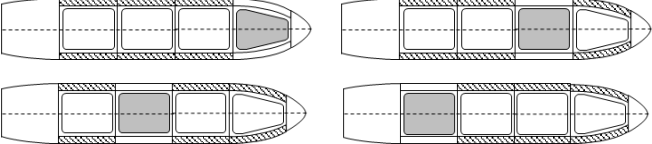
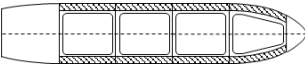
Operational loading conditions	
Full load condition	
1 tank empty condition	
2 tank empty condition	
3 tank empty condition	
Ballast condition	

An2.2 Analytical Loading Condition**An2.2.1**

1 The analytical loading condition refers to a loading condition reproduced using partial structural models in order to appropriately analyse structural responses that may occur in the operational loading condition of **An2.1.1-1**.

An2.3 Examples of Operational Loading Condition and Analytical Loading Condition**An2.3.1 General**

1 Where evaluating the operational loading conditions of a liquefied gas carrier with four holds (*See Fig. An1*), the analytical loading conditions to be examined differ depending on the target hold. The analytical loading conditions of each assessed target hold are referred to **Fig. An2**, **Fig. An3**, **Fig. An4** and **Fig. An5**, respectively. **Fig. An3** and **Fig. An4** may be used as the analytical loading conditions when the No. 2 and No. 3 holds are assessed at the same time.

2 Where considering the requirements of **Table 4.3.2-1 (2)**, **Table 4.3.2-2 (2)** and **Table 4.3.2-3 (2)**, it is necessary to calculate the maximum or minimum vertical still water bending moment that can physically exist by filling or emptying each tank (including the consumption tanks) based on the operational loading condition corresponding to **Fig. An2**, **Fig. An3**, **Fig. An4** and **Fig. An5**.

Fig. An2 Analytical Loading Conditions and Operational Loading Conditions for No. 1 Cargo Hold (Foremost Cargo Hold) Evaluations

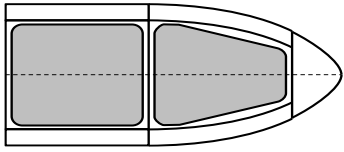
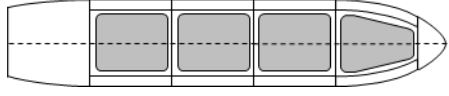
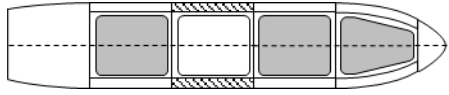
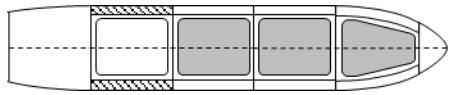
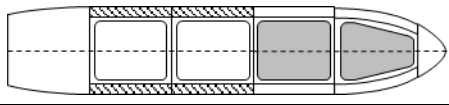
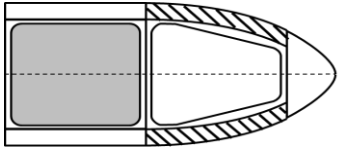
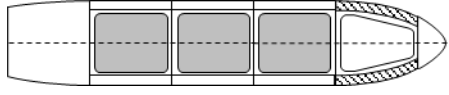
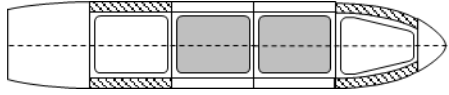
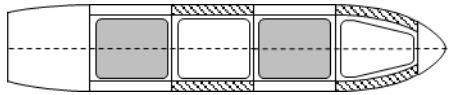
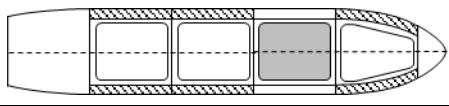
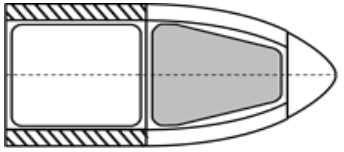
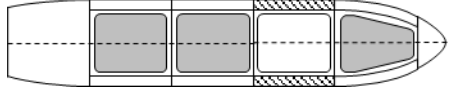
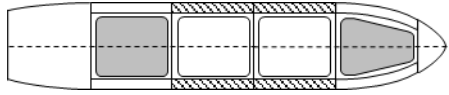
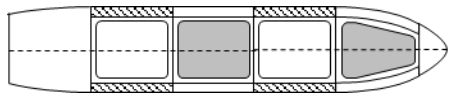
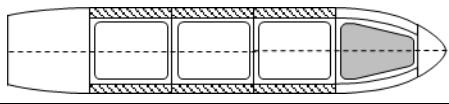
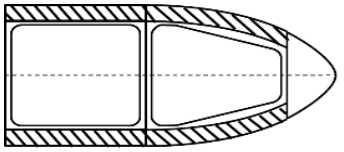
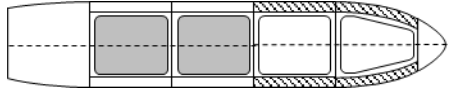
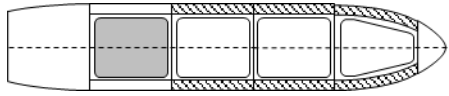
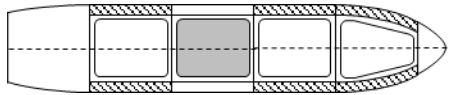
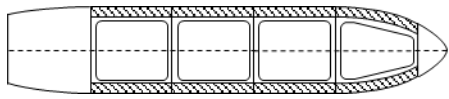
	Analytical loading condition	Operational loading condition that is the basis of the analytical loading condition
<p>S1</p>		
		
		
		
<p>S2</p>		
		
		
		
<p>S4</p>		
		
		
		
<p>S9</p>		
		
		
		

 : Liquid cargo
 : Ballast water

Fig. An3 Analytical Loading Conditions and Operational Loading Conditions
for No. 2 Cargo Hold Evaluations

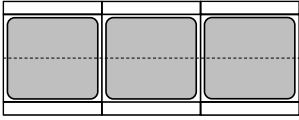
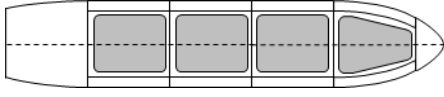
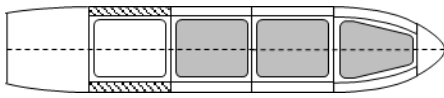
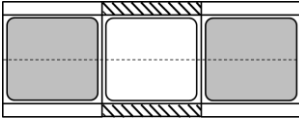
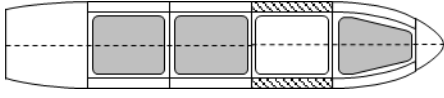
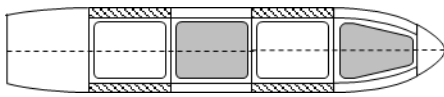
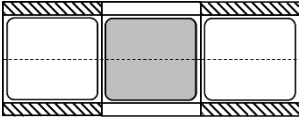
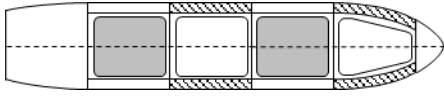
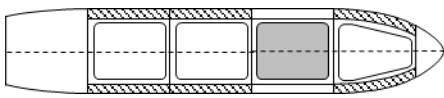
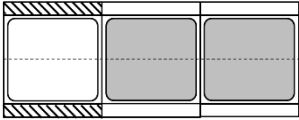
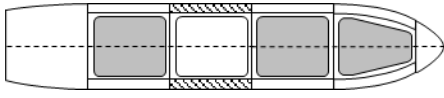
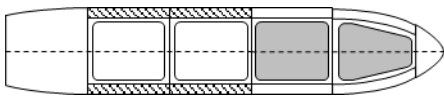
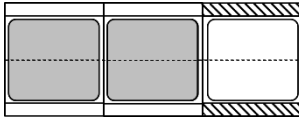
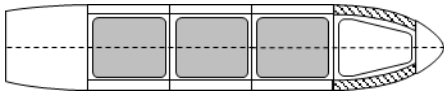
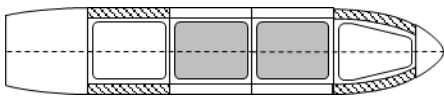
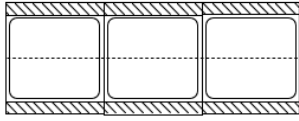
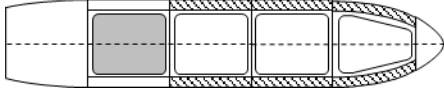
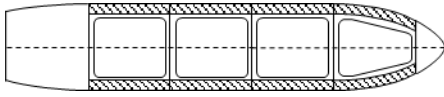
	Analytical loading condition	Operational loading condition that is the basis of the analytical loading condition
S1		
		
S2		
		
S3 S4		
		
S5 S6		
		
S7 S8		
		
S9		
		



: Liquid cargo
: Ballast water

Fig. An4 Analytical Loading Conditions and Operational Loading Conditions
for the No. 3 Cargo Hold Evaluations





	Analytical loading condition	Operational loading condition that is the basis of the analytical loading condition
S1		
S2		
S3 S4		
S5 S6		
S7 S8		
S9		
<p>  : Liquid cargo  : Ballast water </p>		

Fig. An5 Analytical Loading Conditions and Operational Loading Conditions for the No. 4 Cargo Hold (Foremost Cargo Hold) Evaluations

	Analytical loading condition	Operational loading condition that is the basis of the analytical loading condition
S1		
		
		
		
S2		
		
		
		
S4		
		
		
		
S9		
		
		
		

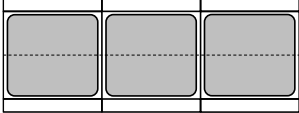
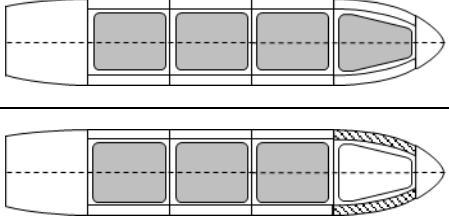
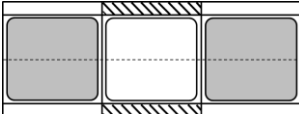
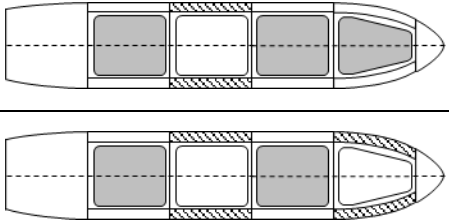
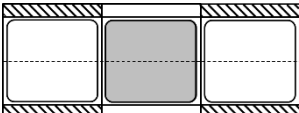
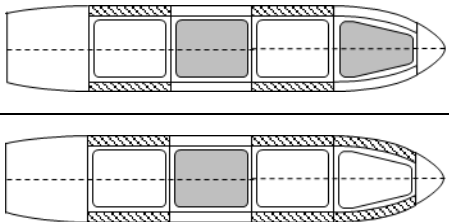
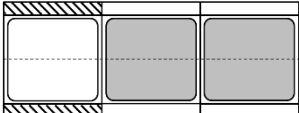
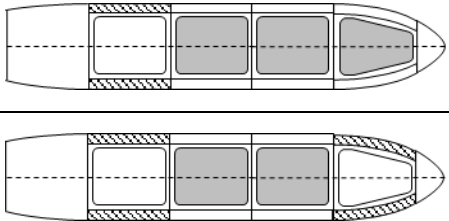
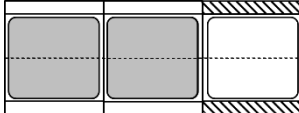
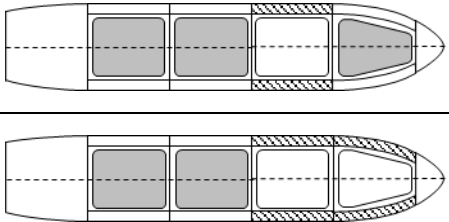
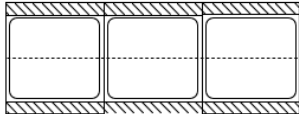
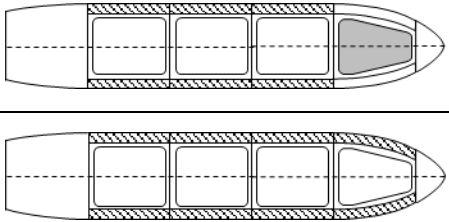
 : Liquid cargo
 : Ballast water

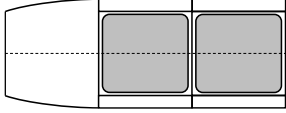
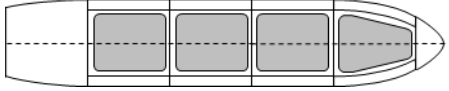
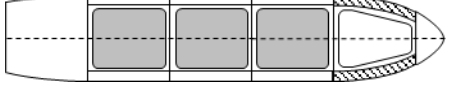
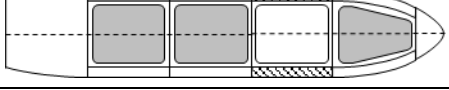
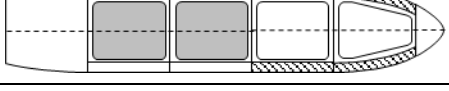
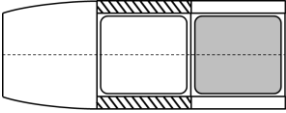
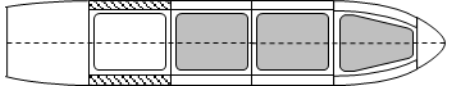
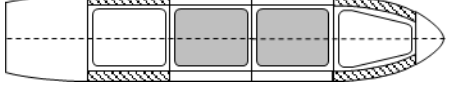
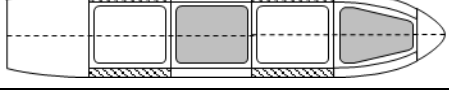
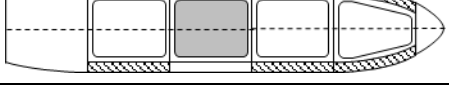
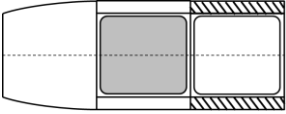
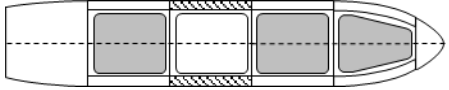
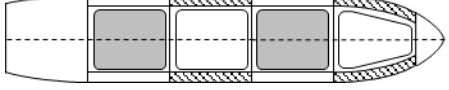
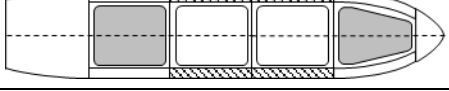
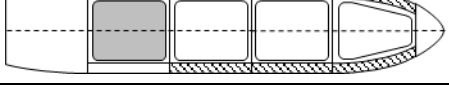
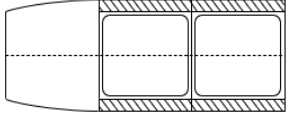
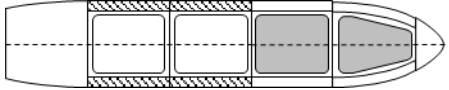
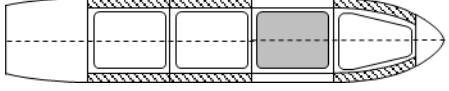
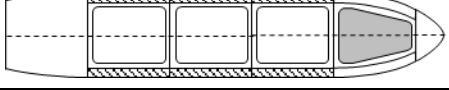
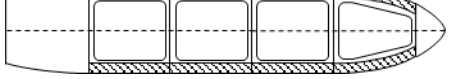
An2.3.2 Loading Condition that Differs from the Analytical Loading Condition

1 In a case where it is difficult to say that it is appropriate to consider the analytical loading condition required by in [4.3.2](#) due to reasons such as the boundary position of the ballast tank being different, the fuel oil tank being located in the cargo hold analysis modelling range, the size of the cargo hold before and after the target hold being significantly different, etc., the loading conditions to be considered are determined on a case-by-case basis, and such loading conditions are to be the ones deemed to be severe for the hull structure of the ship in question.

2 The following **(1)** to **(4)** are to be considered when applying -1 above.

- (1) Difference between internal pressure and external pressure acting on the ship bottom structure or ship side structure
- (2) Internal pressure acting on the bulkhead structure
- (3) Relationship between draught and cargo weight
- (4) Vertical still water bending moment

Chapter 5 LONGITUDINAL STRENGTH

5.1 Hull Girder Ultimate Strength

5.1.1 Strength Criteria

5.1.1.1 Effect of Double Bottom Bending

In the assessment decision specified in [5.4.2.2 in Part 1](#), the coefficient γ_{DB} that takes into account the effect of double bottom bending is as follows.

$$\gamma_{DB} = 1.15$$

Chapter 6 LOCAL STRENGTH

6.1 Independent Prismatic Tanks

6.1.1 General

6.1.1.1 Application

The scantlings of the plates and stiffeners which are subject to internal pressures due to liquid cargoes are to be in accordance with 6.1.

6.1.2 Design Load Scenarios and Applied Loads for Assessment Target Members

6.1.2.1

The design load scenarios and applied loads for assessment target members/compartments are to be in accordance with [Table 6.1.2-1](#).

Table 6.1.2-1 Design Load Scenarios and Applied Loads for Assessment Target Members/Compartments

Members/compartments to be assessed	Design Load Scenarios	Applied load				
		Lateral load	Load type	Load component	Reference	
					Lateral load (P)	Hull girder load (M_{V-HG}, M_{H-HG})
Tank casing	Maximum load condition (normal)	Internal pressure	Liquid cargo	Static/dynamic loads	4.2.3.1	
Tank casing	Harbour condition (normal)	Internal pressure	Liquid cargo	Static load	4.2.3.1	
Tank casing	30-degree static heel condition	Internal pressure	Liquid cargo	Static load	4.2.3.1	
Tank casing	Maximum load condition (Pressure increasing due to a fire)	Internal pressure	Liquid cargo	Static/dynamic loads	4.2.3.2	
Tank casing	Harbour condition (Pressure increasing due to a fire)	Internal pressure	Liquid cargo	Static load	4.2.3.2	
Centreline bulkhead ⁽¹⁾	Maximum load condition (normal)	Internal pressure	Liquid cargo	Static/dynamic loads	4.2.3.3	
Centreline bulkhead ⁽¹⁾	30-degree static heel condition	Internal pressure	Liquid cargo	Static load	4.2.3.3	
Centreline bulkhead ⁽¹⁾	Condition under operational restrictions	Internal pressure	Liquid cargo	Static load	4.2.3.3	

Note:

(1) Where openings which cannot be closed (excluding vapour spaces at the centreline bulkhead) are installed, the requirements need not be applied.

6.1.3 Plates and Stiffeners

6.1.3.1

1 Plates and stiffeners of independent prismatic tanks are to satisfy the requirements of **6.3** and **6.4, Part 1** respectively for design load scenarios and applied loads specified in **Table 6.1.2-1**. In applying **6.3** and **6.4, Part 1**, the following requirements (1) to (3) are to be complied with.

(1) For design load scenarios considering pressure rising due to a fire in those in **Table 6.1.2-1**, the plate and stiffeners are to be evaluated by using formulae for flooded conditions. In addition, for other design load scenarios, the evaluations are to be carried out by using formulae for maximum load conditions.

(2) The coefficients C_a and C_s related to the influence of the axial force are to be taken as 1.0 respectively.

(3) In applying **6.4, Part 1**, C_{Safety} is to be 1.1, and $\sigma_Y/1.33$ or $\sigma_B/2.66$, whichever is less, is to be used instead of σ_Y , where σ_B is the specified minimum tensile strength at room temperature, as specified in **8.5.1.1-2**.

2 In addition to **-1** above, where high density cargoes are partially loaded into cargo tanks, strength assessments are to be carried out taking into account the cargo density and cargo loading height.

3 In structures where the membrane or axial force due to internal pressure cannot be neglected, the requirements in **-1** above is to be applied with necessary modification.

Chapter 7 STRENGTH OF PRIMARY SUPPORTING STRUCTURES

7.1 General

7.1.1 Primary Supporting Structure

7.1.1.1 Members Related to the Primary Support Structure

The scantlings of the members related to the primary support structure are to be determined in accordance with finite element analysis (FEA) based on the requirements of [Chapter 8](#).

Chapter 8 STRENGTH ASSESSMENT BY CARGO HOLD ANALYSIS

8.1 General

8.1.1 General

8.1.1.1 Structure and Overview of this Chapter

1 This Chapter specifies methods for the strength assessment by cargo hold analysis in liquefied gas bulk carriers with independent prismatic tanks type A/B. The requirements in this Chapter specify a method for the strength assessment of the cargo tank structures and supporting structures of the tank, as well as a method for the strength assessment of the primary supporting structures of the hull.

2 The structure and overview of this Chapter are shown in [Table 8.1.1-1](#).

3 The procedures for the strength assessment of the primary supporting structures of the hull and cargo tank structures are shown in [Fig. 8.1.1-1](#), and those for the strength assessment of the supporting structure of the tank are shown in [Fig. 8.1.1-2](#). The strength assessment for the supporting structures of the tank and others is to be performed based on the local structural analysis specified in [8.6](#).

Table 8.1.1-1 Overview of Chapter 8

Section	Title	Overview
8.1	General	Additional requirements related to the overview and application of this Chapter
8.2	Evaluation Area and Members to be Assessed	Additional requirements related to evaluation area and members to be assessed
8.3	Structural Models	Additional requirements related to extent of model, members to be modelled, meshing, etc.
8.4	Boundary Conditions and Load Conditions	Additional requirements related to the boundary conditions and loads conditions
8.5	Strength Assessment	Strength assessment criteria for the primary supporting structures of the hull and cargo tank structures
8.6	Strength Assessment by Local Structural Analysis	The strength assessment method and criteria for the supporting structure and others

Fig. 8.1.1-1 Strength Assessment Flowchart of Primary Supporting Structures of Hull and Cargo Tank Structures

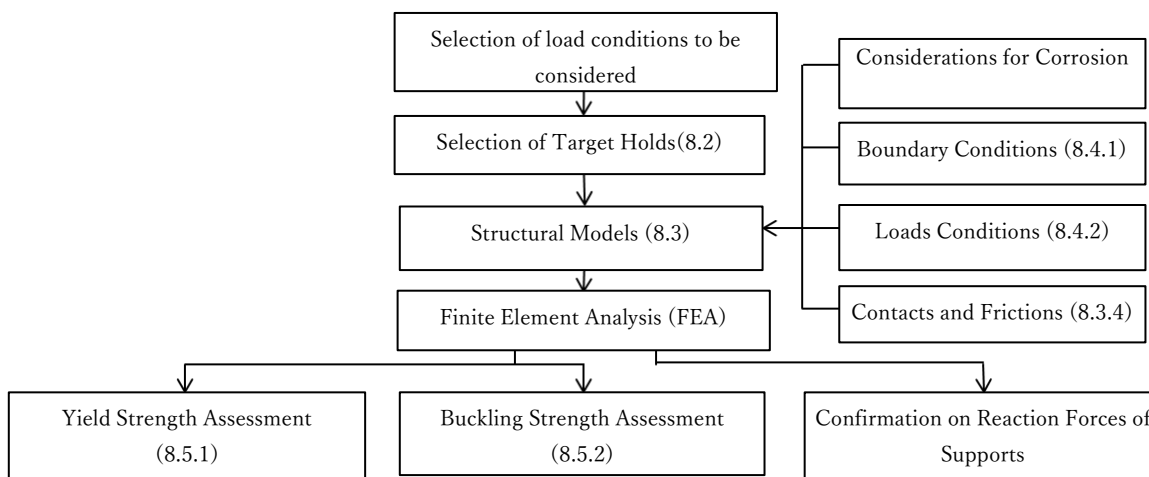

Note: Numbers in parentheses indicate section numbers in Part 2-9.

See also Chapter 8, Part 1 (Fig. 8.1.1-1).

Fig. 8.1.1-2 Strength Assessment Flowchart of Supporting Structures of Tanks

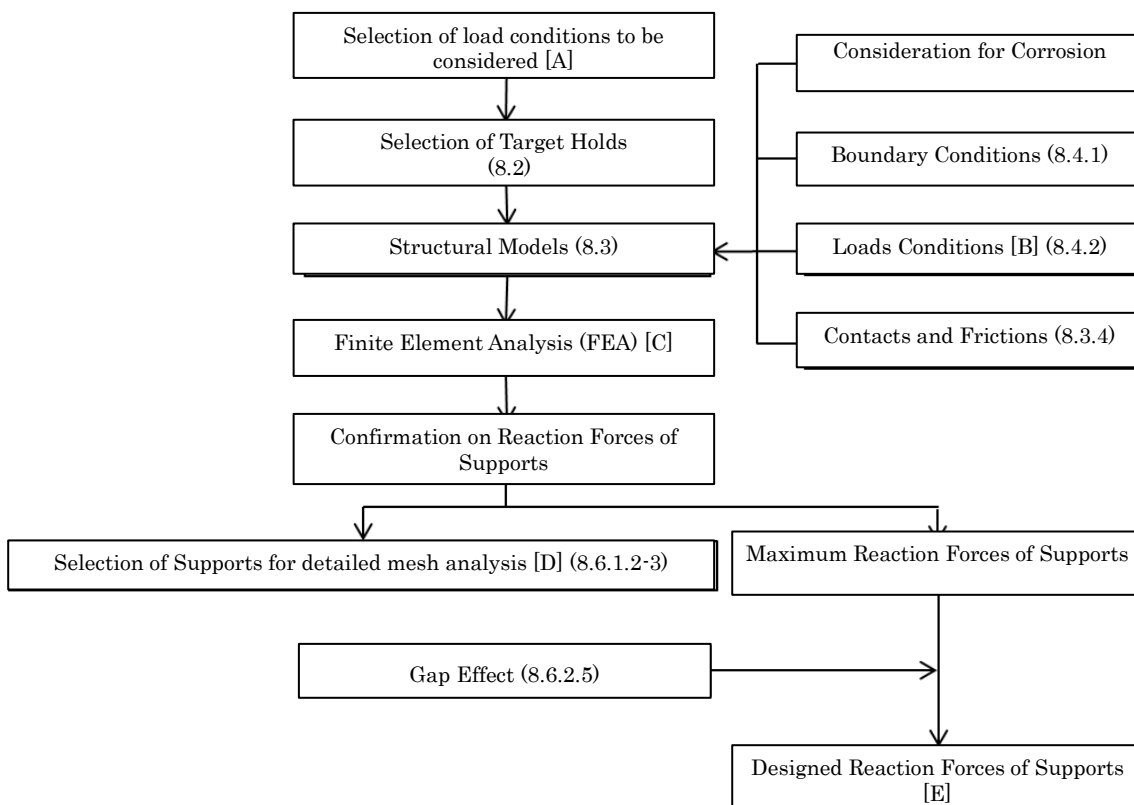

Note: Numbers parentheses indicate section number in Part 2-9.

The symbols in [] correspond to the symbols shown in the Fig. 8.6.1-1.

See also Chapter 8, Part 1 (Fig. 8.1.1-1).

8.1.2 Application

8.1.2.1 Ships to be Assessed

Ships that strength assessment by cargo hold analysis is required, which fall under **8.1.2.1-1(2), Part 1** are to be ships of which the length of L_C is 90 m or more.

8.2 Evaluation Area and Members to be Assessed

8.2.1 Evaluation Area

8.2.1.1 Evaluation Area and Target Holds

- 1 In applying **8.2.1.1-2(1), Part 1**, the cargo hold in the midship part is as defined in **Fig. 8.2.1-1**.
- 2 In applying **8.2.1.1-2(3), Part 1**, the foremost cargo hold and the aftmost cargo hold are to be selected as the target hold. (See **Fig. 8.2.1-1**)

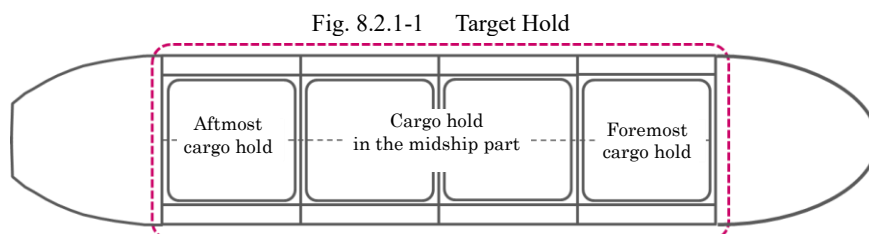

8.2.2 Members to be Assessed

8.2.2.1 General

In applying **8.2.2, Part 1**, the structures and members to be assessed are to be in accordance with **8.2.2**.

8.2.2.2 Members to be Assessed in Maximum Load Condition, Harbour Condition and Testing Condition

Where strength assessment in the maximum load condition, the harbour condition and the testing condition, the members and locations specified in the following **(1)** to **(3)** are to satisfy the criteria specified in this Chapter.

- (1) The structures and members of the hull to be assessed are as follows:
 - (a) Double bottom structure (bottom shell, inner bottom plating, centre girder, side girder and floor)
 - (b) Double side structure (side shell, longitudinal bulkhead, side stringer and side transverse)
 - (c) Single-side skin construction (side shell and side frame)
 - (d) Bilge hopper tank structure (hopper tank sloping and girders inside the tank)
 - (e) Topside tank structure (topside tank sloping plate and girders inside the tank)
 - (f) Deck structure (upper deck and tank dome opening)
 - (g) Bulkhead structure (transverse bulkhead and longitudinal bulkhead)
 - (h) Other members and locations deemed necessary by the Society
- (2) The structures and members of the cargo tank construction to be assessed are as follows:
 - (a) Tank boundary forming independent prismatic tank
 - (b) Centreline bulkhead in independent prismatic tank
 - (c) Swash bulkhead in independent prismatic tank
 - (d) Primary supporting members in independent prismatic tank (transverses and girders)
- (3) The structures and members of local detailed structures to be assessed are as follows:
 - (a) The supporting structures of cargo tank structures are to be assessed, in accordance with the following **(i)** to **(vi)**.
 - i) Supports in vertical direction (e.g. bottom supports) as well as adjacent hull and cargo tank structures
 - ii) Supports in transverse direction (e.g. anti-rolling chocks) as well as adjacent hull and cargo tank structures
 - iii) Supports in longitudinal direction (e.g. anti-pitching chock) as well as adjacent hull and cargo tank structures
 - iv) Anti-floatation arrangements (e.g. anti-floatation chocks) as well as adjacent hull and cargo tank structures
 - v) Bearing blocks inserted in the contact surfaces of the cargo tanks and any of the supports listed in **(i)** to **(iv)** above
 - vi) Coamings, dam plates and securing bolts
 - (b) Structural discontinuous parts other than supporting structures
 - i) Tank dome openings in decks (areas difficult to be assessed in accordance with **(1)** above)
 - ii) Other locations deemed necessary by the Society

8.2.2.3 Members to be Assessed in 30-Degree Static Heel Condition

Where strength assessment in 30-degree static heel condition is carried out, the members and locations specified in **8.2.2.2(2)** and **(3)(a)** are to satisfy the criteria specified in this Chapter.

8.2.2.4 Members to be Assessed in Collision Condition and Flooded Condition (IGC)

When strength assessment in collision condition and flooded condition (IGC) is carried out, the members and locations specified in **8.2.2.2 (3)(a)** are to satisfy the criteria specified in this Chapter.

8.3 Structural Models**8.3.1 General****8.3.1.1 Extent of Model**

In applying **8.3.1.1, Part 1**, the model is, in principle, to represent three adjacent cargo holds with the target hold in the middle and the full depth and the full width of the holds are to be modelled.

8.3.1.2 Members to be Modelled

In addition to modelling of the hull construction, bulkheads and primary structural members of cargo tanks and supporting structures of the tanks are to be modelled.

8.3.2 Elements**8.3.2.1 Properties of Elements**

Density of materials is to be adjusted in consideration of the weight of equipment such as unmodeled cargo pumps, piping, etc. and insulation.

8.3.2.2 Element Types

1 The bearing blocks inserted in the contact surfaces of the cargo tanks and any of supports are to be modelled using the elements by which analysis taken contacts and frictions occur on the contact surface into account can be carried out appropriately.

2 Members of the tripping brackets, etc. that surround the supports are to be modelled using shell elements.

8.3.3 Meshing, etc.**8.3.3.1 General**

1 Any of supports is to be modelled so that analysis taken contacts and frictions occur on the contact surface into account can be carried out appropriately in accordance with **8.3.4**.

2 As for any of supports and their surrounding structures, stiffness of the actual construction is to be reproduced as much as possible, especially for the stiffness of supporting direction.

3 The coamings of tank dome openings are to be modelled so as to reproduce the actual construction as much as possible.

8.3.4 Contacts and Frictions**8.3.4.1 Settings for Considering the Contacts and Frictions**

1 Where strength assessment for the hull construction and cargo tank structure is carried out, the contacts between the cargo tanks and various supports and the frictions that occur on the contact surface of the cargo tanks and various supports are to be considered based upon any of the methods specified in the following **(1)** to **(3)**:

- (1) A method in which the contacts and frictions are analysed by defining the contact and friction conditions for the elements on the contact surface in the analysis program.
- (2) A method in which the contacts and frictions are analysed using gap elements. This method considers the contact and friction by matching the element decomposition of the surfaces that are thought be in contact, creating the elements that connect the two corresponding points one by one, and setting the contact direction (the direction in which the gap closes) and the initial gap. If two different points that are connected are displaced relative to the opening direction of the gap, they will not be constrained and the final state will be calculated by repeatedly calculating. If two different points that are connected are displaced relative to the closing direction of the gap, the final state will be calculated by repeatedly calculating while constraining the set initial gap as much as possible.
- (3) A method in which the contacts and frictions are analysed using rod elements or beam elements. This method calculates the final state by repeatedly calculating while applying a rod or beam element to the contact part and, for contact, deleting the element that generates a tensile reaction force, and, for friction, setting the shear rigidity and flexural rigidity of the beam

element that exceeds the maximum friction force to 0. The term maximum frictional force used here means a value obtained by multiplying the reaction force generated in each support structure by the friction coefficient μ .

2 Where strength assessment for the supporting structures of the tanks is carried out, in principle, the method specified in -1(1) above is to be used in order to estimate an appropriate distribution of reaction forces and friction forces that occur on the supporting structures.

8.3.4.2 Friction Forces that Occur between Cargo Tank and Various Supports

1 The magnitude of the frictional forces is to be considered up to the value obtained by multiplying the reaction force value generated in each support structure by the friction coefficient μ .

2 The frictional coefficients for the analysis according to the combinations of typical materials used in the contact surface are shown in [Table 8.3.4-1](#).

Table 8.3.4-1 Typical Frictional Coefficients μ

Combinations of materials in contact with each other		Frictional coefficient μ
Material 1	Material 2	
Steel	Wood	0.2
Steel	Resin	0.2

8.4 Boundary Conditions and Loads Conditions

8.4.1 Boundary Conditions

8.4.1.1

In applying [8.5.1, Part 1](#), the boundary conditions are to be in accordance with [8.4.1, Part 2-8](#).

8.4.2 Loads Conditions

8.4.2.1 Loads to be Considered

In applying [8.5.2, Part 1](#), loads based also upon the additional requirements specified in [4.3](#) are to be considered.

8.4.2.2 Method of Applying Moments to the Structural Model

In applying [8.5.2, Part 1](#), the vertical bending moment and horizontal bending moment act on the target hold are to be adjusted in accordance with the method specified in [8.4.2, Part 2-8](#).

8.5 Strength Assessment

8.5.1 Yield Strength Assessment

8.5.1.1 Criteria

1 The yield strength assessment for the primary supporting structures of hull is to be in accordance with the requirements of [8.6.1, Part 1](#).

2 In the yield strength assessment for the cargo tank structures of the tank-type *A*, the criteria obtained by the following formula are to be satisfied.

$$\lambda_y \leq \lambda_{perm}$$

λ_y : Yield utilisation factor, as given by the following formula. For rod elements, σ_{eq} is to be taken as σ_a .

$$\text{For ferrite steels, } \lambda_y = \frac{\sigma_{eq}}{\min(0.79\sigma_Y, 0.53\sigma_B)}$$

σ_B : Specified minimum tensile strength at room temperature (N/mm^2), taken as follows.

For *KL 24*, taken as 400.

For *KL 27*, taken as 420.

For *KL 33*, taken as 440.

For *KL 37*, taken as 490.

λ_{perm} : Permissible yield utilisation factor, as specified in [Table 8.5.1-1](#).

3 As for yield strength assessment for the cargo tank structures of the tank-type *B* other than except the assessment in test condition, the criteria obtained by the following formula are to be satisfied.

$$\lambda_y \leq \lambda_{perm}$$

λ_y : Yield utilisation factor, as given by the following formula. For rod elements, σ_{eq} is taken as σ_a .

$$\text{For nickel steels, carbon manganese steels, } \lambda_y = \frac{\sigma_{eq}}{\min(0.83\sigma_Y, 0.5\sigma_B)}$$

$$\text{For austenitic steels and alminum alloys, } \lambda_y = \frac{\sigma_{eq}}{\min(0.83\sigma_Y, 0.4\sigma_B)}$$

λ_{perm} : Permissible yield utilisation factor, as specified in **Table 8.5.1-1**.

4 As for yield strength assessment for the cargo tank structures of tank-type *B* in testing condition, the yield utilisation factor obtained by the following formula is to satisfy the criteria as specified in -3 above.

$$\lambda_y = \frac{\sigma_{eq}}{0.75\sigma_Y}$$

Table 8.5.1-1 Permissible Yield Utilisation Factor

Structures to be assessed	Maximum load condition	Testing condition	30-degree static heel condition	Harbour condition	
				The condition that one side of the cargo tank is fully loaded : where asymmetric loading of both sides of the tanks is not allowed. ⁽¹⁾	The condition that both sides of the cargo tank are fully loaded, or one side of the cargo tank is fully loaded: where asymmetric loading of both sides of cargo tanks is allowed.
Cargo tank (Type <i>A</i>) structure	1.0	1.0	1.0	1.0	0.85
Cargo tank (Type <i>B</i>) structure	1.0	1.0 ⁽²⁾	1.0	1.0	0.85

Notes:

(1) In case asymmetric loading of both sides of cargo tanks is not allowed in harbour condition, it is to be clearly stated in the loading manual as an operational restriction.

(2) Provided that the accuracy of analysis is verified through prototype testing by using appropriate devices such as strain gauges, the value 1.2 may be used. (See **4.22.6(2), Part N**).

8.5.2 Buckling Strength Assessment

8.5.2.1 Criteria

- 1 The buckling strength assessment for the primary supporting structures of the hull is to be in accordance with **8.6.2, Part 1**.
- 2 The buckling strength assessment for the cargo tank structures is to be in accordance with **Table 8.5.2-1**.

Table 8.5.2-1 Permissible Buckling Utilisation Factor

Structure to be assessed	Maximum load Condition	Testing condition	30-degree static heel condition	Harbour condition	
				The condition that one side of the cargo tank is fully loaded : where asymmetric loading of both sides of the tanks is not allowed. ⁽¹⁾	The condition that both sides of the cargo tank are fully loaded, or one side of the cargo tank is fully loaded: where asymmetric loading of both sides of cargo tanks is allowed.
Cargo tank (Type A) structure	0.9	0.9	0.9	0.9	0.77
Cargo tank (Type B) structure	0.9	0.9	0.9	0.9	0.77

Notes:

(1) In case asymmetric loading of both sides of cargo tanks is not allowed in harbour condition, it is to be clearly stated in the loading manual as an operational restriction.

8.5.2.2 Side Shell Plating with Transverse Stiffness

1 In applying **Annex 8.6, Part 1 “Buckling Strength Assessment based on Cargo Hold Analysis”**, for the side shell with stiffened in transverse direction which is surrounded by the bilge hopper tanks and top side tanks, the stress act on the members in the shorter side direction of the panels may be averaged regardless of the definition of the reference stress σ_y , which is in the shorter side direction of the panels specified in **An3.2.2, Annex 8.6**.

2 In the application of -1 above, where the requirements for hull girder ultimate strength specified in **5.4, Part 1** are satisfied, for the strength assessments performed in the equivalent design waves *HM-1*, *FM-1*, *AV-1P* and *AV-1S* of the maximum load condition, the stress under the shorter side direction of the panels acting on the said members is to be considered up to the value obtained by the following formula:

$$\sigma_{y_limit} = \frac{\pi^2 E}{12(1-\nu^2)} \left(\frac{t_p}{b}\right)^2$$

E : Young’s modulus (N/mm^2), taken as 2.06×10^5 .

ν : Poisson’s ratio, taken as 0.3.

t_p : Thickness (mm) of the plate panel.

b : Length (mm) of the shorter side of the plate panel.

8.6 Strength Assessment by Local Structural Analysis

8.6.1 General

8.6.1.1 Application

1 The strength assessment method for various supports of cargo tanks and their surrounding structures is to be in accordance with the requirements of **8.6**.

2 The requirements of **8.6** may be applied for hull structure and cargo tank structures other than cargo tank supports and their surrounding structures, provided that strength assessment using finite element analysis is carried out.

8.6.1.2 Assessment Procedure of Supporting Structures

1 For various supports and hull and cargo tank structures adjacent to the supports, strength assessment is to be carried out by finite element analysis using structural models with mesh size finer than the typical mesh size specified in **8.3.3.1, Part 1** (hereinafter referred to as local models). a model in which local models are inserted in the structural model specified in **8.3** (inserted model) or the

local models are to be used.

2 Structural analysis using inserted model or local models is to be carried out for typical supports considering the reaction force and displacements of various supports obtained by cargo hold analysis using the structural model specified in 8.3, and considering the type of construction of the supporting structures including the structures adjacent to the supports. At least, one location is to be assessed for each type and structure of supports.

3 Loads of combination of the loading condition to be considered, the wave condition and etc. are to be considered.

4 The loads for assessing the supporting structure are to be the same as those for assessing strength assessment of the cargo tank structures. However, structural analysis may be carried out considering only the loads which are dominant the supporting structures to be assessed (for example, the load that maximizes the reaction force act on the supporting structure).

5 The loads to be considered and the boundary conditions are to be applied to the structural model, and stress is to be calculated using 3-dimensional finite element analysis. The following items (1) to (3) are to be considered.

(1) Gap effect

(2) Distribution of reaction forces that can occur on the contact surface between the cargo tank and various supports

(3) Friction force that can occur on the contact surface between the cargo tank and various supports

6 Strength assessment specified in the following (1) and (2) is to be carried out based upon the calculated stress.

(1) Strength assessment for stress concentration areas such as bracket toes

(2) Strength assessment for stress fields at locations other than (1) above (assessment classified as yield strength assessment in typical mesh size)

Fig. 8.6.1-1 Strength Assessment Flow of Supporting Structures Using Local Models or Embedded Models

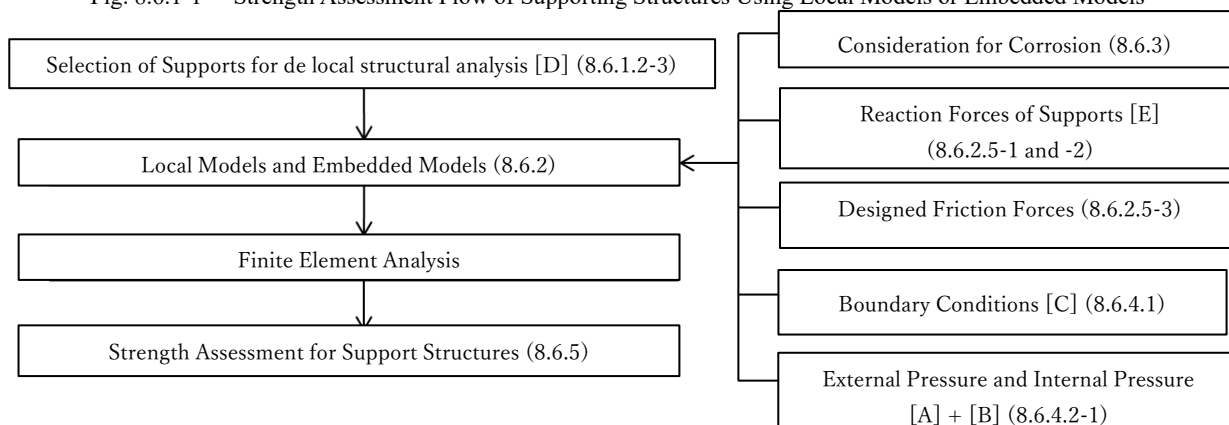

8.6.1.3 Assessment Procedure for Structural Discontinuous Parts other than Supporting Structures

For the assessment of structural discontinuous parts other than the supporting structures, 8.6.1.2 may be applied. The requirements of (1) to (3) in 8.6.1.2-5 may not be considered.

8.6.2 Structural Models

8.6.2.1 Extent of Model

1 Where structural analysis using local models are carried out, the extent of model is to be determined so as not to affect structural response of members to be assessed significantly by the boundary conditions. Moreover, the end of the local model is to match the primary supporting members of the structural model specified in 8.3.

2 The minimum extent of the local model is to be in accordance with Table 8.6.2-1.

Table 8.6.2-1 Minimum Extent of Local Models

Vertical direction	Depth of cargo tank girder from tank bottom plating or tank top plating
Transverse direction	Each one girder spacing on the left and right of the assessment target (i.e. two girder spacing in total)
Longitudinal direction	Each one transverse spacing to the fore and aft direction of assessment target (two transverse spacing)

3 Where embedded models are used, the local models are to be inserted in the structural models specified in 8.3.

8.6.2.2 Members to be Modelled

1 In addition to the members specified in 8.3.1.2, small brackets and face plates attached to the brackets are also to be modelled within the range of the meshing of 50 mm size specified in 8.6.2.4.

2 Members and small openings expected to affect the structural response of the locations to be assessed are to be modelled.

8.6.2.3 Types of Elements

1 The types of elements used in local models are to be in accordance with the following (1) to (4).

- (1) Plating is to be modelled using shell elements.
- (2) Stiffeners within the range of using the mesh size specified in 8.6.2.4-1 are to be modelled using shell elements. Otherwise, stiffeners may be modelled using beam elements. However, the eccentricity of the neutral axis is to be considered.
- (3) The flanges of the primary supporting members and the flanges of the brackets within the range of using the mesh size specified in 8.6.2.4-1 are to be modelled using shell elements. Otherwise, rod elements or beam elements may be used.
- (4) Bearing blocks inserted into the contact surfaces of various supports are to be modelled using solid elements.

2 In the inserted model, the types of elements used for other than the local model are to be in accordance with 8.3.

8.6.2.4 Meshing

1 The mesh size of local models is to be 50 mm × 50 mm or less.

2 For at least ten elements in all directions from the locations to be assessed, the requirements of -1 above are to be followed. Mesh size outside the range is to change smoothly.

8.6.2.5 Other Items to be Considered

1 The design reaction forces considering the gap effect are to be based on the following (1) to (3):

- (1) The tolerance assumed when installing the cargo tank are to be examined, and the resulting increment of reaction force as the gap effect are to be considered. In this case, documents of investigations are to be submitted to the Society. However, the gap effect in the assessment of the anti-floatation arrangements may not be considered.
- (2) Where the investigation specified in (1) above is not carried out, the gap effect is to be an increase in reaction force 12 % per 1 mm of work tolerance for the vertical support, and is to be an increase in reaction force of 10 % per 1 mm tolerance for the left-right direction support and longitudinal direction support.
- (3) When the tolerance is 0 mm in the work management of various supports, the increase in reaction force may not be considered.

2 The presence of the distribution of design reaction forces that may occur in the contact surface between the cargo tank and various supports are to be considered (See Fig. 8.6.2-1).

3 The design friction forces that can occur on the contact surface between the cargo tank and the various supports are to be considered.

Fig. 8.6.2-1 Example of Reaction Force Distribution on the Contact Surface of a Support

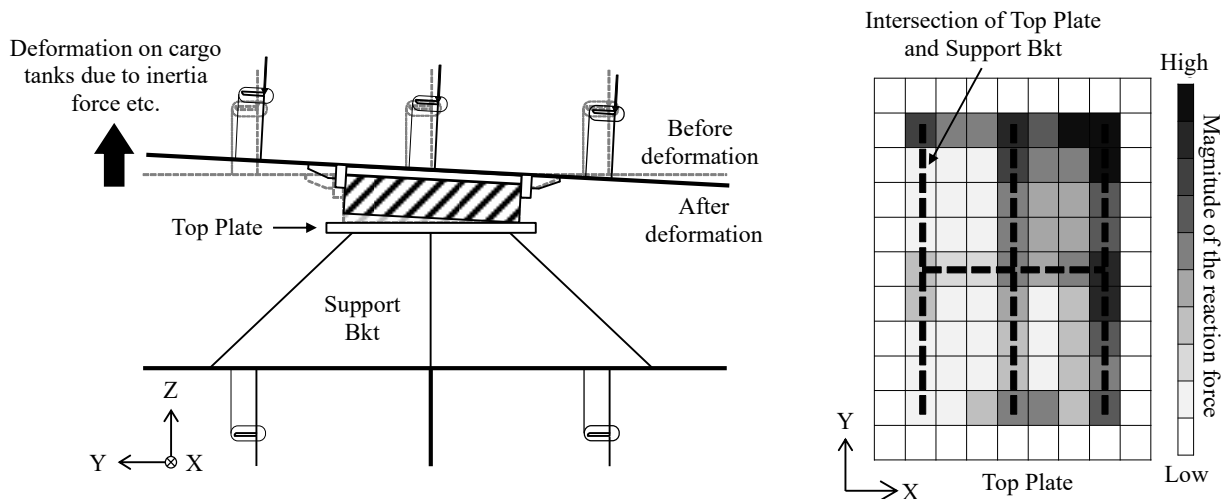

8.6.3 Consideration for Corrosion

8.6.3.1 Net Scantling Approach

For the plate thickness of the local model and the scantlings of the stiffener, the net scantling approach specified in [3.3, Part 1](#) is to be applied.

8.6.4 Boundary Conditions and Loads Conditions

8.6.4.1 Boundary Conditions

1 Where structural analysis using an inserted model is carried out, the requirements of [8.4.1](#) are to be followed. Where there are independent point discrepancies at the boundaries of a local model, forced displacements may be applied to these independent points using multipoint constraints. The use of linear multipoint constraint relations for two adjacent independent points may be considered.

2 Where structural analysis using only local models are carried out, the displacement obtained by the structural analysis based on the structural model of [8.3](#) and the calculation conditions of [8.4](#) is to be applied to the independent points at the ends of the local model.

8.6.4.2 Loads Conditions

1 Loading conditions and wave conditions specified in [4.3](#) are to be taken into consideration. When performing an analysis using only a local model, the loads (external pressure and internal pressure) acting on the structure reproduced in the model are to be appropriately applied.

2 The load on the contact surface of a support is to be in accordance with the requirements of [8.6.2.5](#).

3 In various supports and their peripheral structures, analysis corresponding to the following Case A or B is to be carried out for each loading condition in accordance with [Table 8.6.4-1](#). However, regarding the state and combination of the reaction force and friction force of a support, a detailed study can be conducted in consideration of the support arrangement and the symmetry of the supporting structure, and where deemed appropriate by the Society, part or all of Case B may be omitted.

Case A: An integrated model consisting of a hull structure and a cargo tank structure in an analysis case that considers the magnitude (with distribution) of the reaction force generated on the contact surface and the magnitude (with distribution) and orientation of the friction force in each loading condition (See [Fig. 8.6.4-1](#)) are to be used. For the loads of various supports in this case, refer to [Table 8.6.4-2](#).

Case B: Models of hull structure and cargo tank structure (See [Fig. 8.6.4-2](#)) are used in the analysis case considering the reaction force (equal distribution) generated on the contact surface and the friction force (equal distribution) in a specified direction. For the loads of various supports in this case, refer to [Table 8.6.4-3](#).

Table 8.6.4-1 Analysis Case

Support	Loading condition	Analysis case	Design reaction force and friction force
Support in vertical direction	Maximum load condition	Case A and Case B	In the case of Case A, refer to Table 8.6.4-2 . In the case of Case B, refer to Table 8.6.4-3 .
	30-degree static heel condition		
	Testing condition		
Support in transverse direction	Maximum load condition	Case A and Case B	
	30degree static heel condition		
Support in longitudinal direction	Maximum load condition	Case A and Case B	
	Collision condition		
Anti-floatation arrangement	Flooded condition(IGC)	Case A	

Fig. 8.6.4-1 Example of Analysis Model of Case A

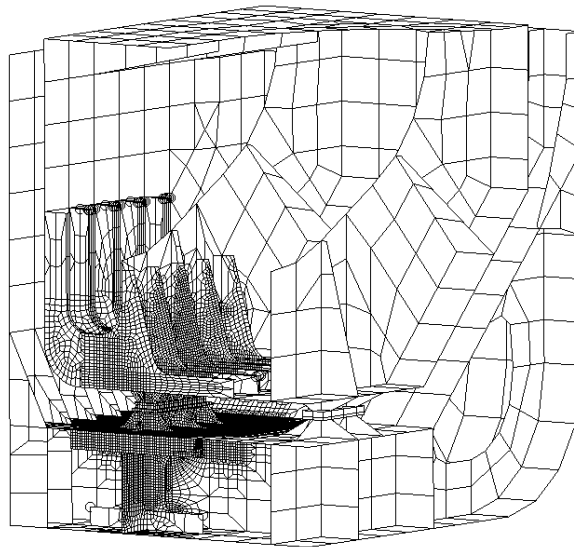

Fig. 8.6.4-2 Example of Analysis Model of Case B

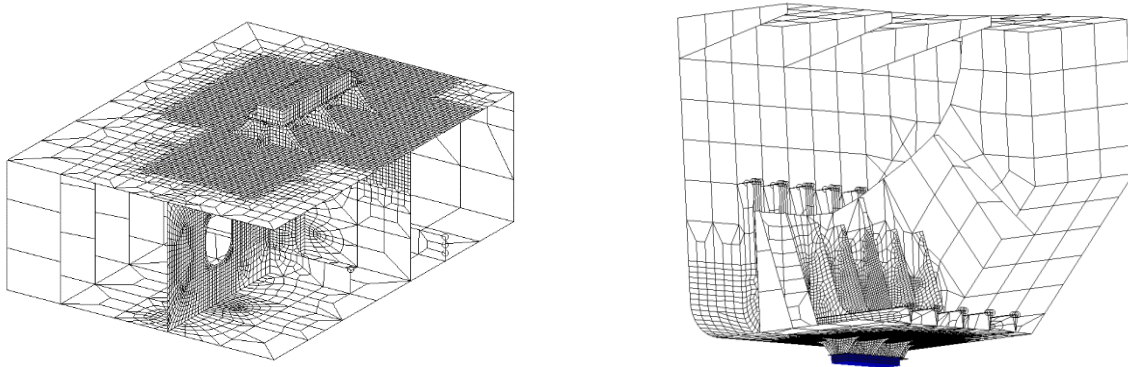

Table 8.6.4-2 Loads to be Considered for Supports in Case A

Support type	Design reaction forces		Distribution	Design friction forces		
	Size			Value	Distribution	Direction
	Design maximum reaction forces	Gap effect				
Support in vertical direction	R_Z	to be considered ⁽¹⁾	Automatically considered by analysis.	Automatically considered by analysis, with the value obtained by multiplying the design reaction force by the frictional coefficient μ as a maximum.	To be considered automatically through an analysis.	
Support in transverse direction	R_Y	to be considered ⁽¹⁾				
Support in longitudinal direction	R_X	to be considered ⁽¹⁾				
Anti-floatation arrangement	$R_{F,Z}$	Not considered				

Notes:

R_X : Reaction force in longitudinal direction generated on support in longitudinal direction (kN)

R_Y : Reaction force in transverse direction generated on supports in transverse direction (kN)

R_Z : Reaction force in vertical direction generated on support in vertical direction (kN)

$R_{F,Z}$: Reaction force in vertical direction generated on the anti-floatation arrangement (kN)

μ : Friction coefficient of contact surface

(1) The gap effect may be considered by adding the gap effect to the stress component obtained by analysis.

Table 8.6.4-3. Support Load Considered in Case B

Types of supports	Designed reaction force		Distribution	Designed friction force		
	Value			Magnitude	Distribution	Direction
	Designed maximum reaction force	Gap effect				
Vertical direction support	R_Z	Considered	None ⁽¹⁾	$C_F \times \mu \times R_Z$	None	+X direction -X direction +Y direction -Y direction
horizontal direction support	R_Y	Considered		$C_F \times \mu \times R_Y$		+X direction -X direction
Longitudinal direction support	R_X	Not considered		$C_F \times \mu \times R_X$		+Y direction -Y direction

Notes:

R_X, R_Y, R_Z, μ : As specified in [Table 8.6.4-2](#).

C_F : Effective friction coefficient, taken as follows.

For a vertical support, 0.5

For a horizontal and front-rear support, 0.2

(1) The design reaction force is to be applied evenly through the bearing block.

8.6.5 Strength Assessment

8.6.5.1 Reference Stress

1 As the reference stress used for strength assessment, the shell element is to be in accordance with the requirements of **8.6.1.1-1, Part 1**.

2 When using a mesh finer than the mesh of $50\text{ mm} \times 50\text{ mm}$, the value obtained by averaging the stresses of multiple elements may be used as the reference stress within the range corresponding to the mesh of $50\text{ mm} \times 50\text{ mm}$. However, it cannot be averaged beyond the structural discontinuous parts.

8.6.5.2 Criteria for Stress Concentration in Each Supporting Structure

1 Strength assessment is to be performed using the reference stress specified in **8.6.1.1-1, Part 1**.

2 All members to be assessed are to satisfy the following criteria:

$$\lambda_y \leq \lambda_{perm}$$

λ_y : The yield utilisation factor is based on the requirements of **8.6.5.2-3**, **8.6.5.2-4** and **8.6.5.2-5** depending on the assessment target. However, in the case of collision condition and flooded condition (IGC), the requirements of **8.6.5.2-7** are to be applied regardless of the assessment target.

λ_{perm} : Permissible yield utilisation factor, taken as 1.0.

3 The following yield utilisation factor is to be used for strength assessment of various supports.

$$\lambda_y = \frac{\sigma_{eq}}{C_{fa} C_m \sigma_Y}$$

C_{fa} : Coefficient for fatigue, taken as 1.0. However, taken as 1.2 for structures that satisfy the criteria for fatigue strength assessment specified in **Chapter 9**.

C_m : Coefficient, taken as 1.7 for elements that do not come into contact with welding, 1.5 for elements that come into contact with welding.

4 The following yield utilisation factor is to be used in strength assessment of a tank type *A* cargo tank structure.

$$\lambda_y = \frac{\sigma_{eq}}{C_{fa} C_m \cdot \min(0.79\sigma_Y, 0.53\sigma_B)}$$

C_{fa} , C_m : As specified in -3 above.

σ_B : Specified minimum tensile strength (N/mm^2) at room temperature, as specified in **8.5.1**.

5 The following yield utilisation factor is to be used in strength assessment of a tank type *B* cargo tank structure.

$$\text{For nickel steels, carbon manganese steels, } \lambda_y = \frac{\sigma_{eq}}{C_{fa} C_m \cdot \min(0.83\sigma_Y, 0.5\sigma_B)}$$

$$\text{For austenitic steels and aluminum alloys, } \lambda_y = \frac{\sigma_{eq}}{C_{fa} C_m \cdot \min(0.83\sigma_Y, 0.4\sigma_B)}$$

C_{fa} , C_m : As specified in -3 above.

σ_B : As specified **8.5.1** above.

6 The following yield utilisation factor is to be used for strength assessment of hull structure.

$$\lambda_y = \frac{\sigma_{eq}}{C_{fa} C_m \cdot 235/K}$$

C_{fa} , C_m : As specified in -3 above.

7 Regardless of the assessment target, the following yield utilisation factor is to be used for strength assessment of collision condition and flooded condition (IGC).

$$\lambda_y = \frac{\sigma_{eq}}{1.87\sigma_Y}$$

8.6.5.3 Criteria for Other Stress Concentration

1 Strength assessment is to be performed using the reference stress specified in **8.6.1.1-1, Part 1**. The average value of the stresses of the elements in the range of the typical mesh size specified in **8.3.3, Part 1** may be used. However, it is not to be averaged beyond different structures and structural discontinuous parts.

2 Various supports are to satisfy the following criteria.

$$\lambda_y \leq \lambda_{perm}$$

λ_y : Yield utilisation factor, as given by the following formula:

$$\lambda_y = \frac{\sigma_{eq}}{\sigma_Y}$$

λ_{perm} : Permissible yield utilisation factor to be taken as 1.0.

3 The hull structure and cargo structure adjacent to various supports are to satisfy the following criteria for collision condition and flooded condition (IGC). In the case of such structure, other conditions (maximum load condition, etc.) may not be assessed.

$$\lambda_y \leq \lambda_{perm}$$

λ_y : Yield utilisation factor, as given by the following formula:

$$\lambda_y = \frac{\sigma_{eq}}{\sigma_Y}$$

λ_{perm} : Permissible yield utilisation factor to be taken as 1.0.

8.6.5.4 Bearing Block Assessment

In principle, the direct stress σ (N/mm^2) and shear stress τ (N/mm^2) generated by the design reaction force R_{des} (kN) and design friction force F_{des} (kN) of a support of a bearing block are to satisfy the following criteria.

$$\sigma = \frac{R_{des}}{A_B} \times 10^{-3} < \frac{\sigma_{strength}}{C_S}$$

$$\tau = \frac{F_{des}}{A_B} \times 10^{-3} < \frac{\tau_{strength}}{C_S}$$

A_B : Cross-sectional area parallel to the contact surface of the bearing block (m^2)

$\sigma_{strength}$: Minimum compressive strength of bearing block (N/mm^2)

$\tau_{strength}$: Minimum shear strength of bearing block (N/mm^2)

C_S : Safety factor, as specified in [Table 8.6.5-1](#).

Table 8.6.5-1 Safety Factors

Scenario under consideration	C_S
Maximum load condition	3.0
30-degree static heel condition	
Testing condition	
Collision condition/flooded condition(IGC)	1.5

8.6.5.5 Assessment of Other Members

1 Coaming/dam plates and secure ring bolts are to be properly assessed to have a structure that can withstand the shear forces generated by the bearing blocks receiving frictional forces. The standard is to design a support so that it is safe against a shear force of 10% of the reaction force.

2 The top plate of various supports and the bottom plate of a cargo tank (supporting structure) are to be properly assessed so that the structure does not cause excessive deformation due to lateral load due to the design reaction force of the support.

Chapter 9 FATIGUE

9.1 General

9.1.1 General

9.1.1.1 Overview

1 Unless otherwise specified, the fatigue strength assessment method for the connections of platings and girders and free edges of the base metals by finite element stress analysis for ships carrying liquified gases in bulk (independent prismatic tank type A/B) is to be in accordance with this Chapter instead of [Chapter 9, Part 1](#).

2 Regardless of the requirement in -1 above, the fatigue strength assessment of structural components of cargo tank and supports (cargo tank side) of ships carrying liquified gases in bulk fitted with independent prismatic tank type B is to be in accordance with [4.22.4, Part N](#).

3 The definitions of various supports that are required to be assessed in this Chapter and the application of fatigue strength assessment to each support are shown in [Fig. 9.1.1-1](#) and [Table 9.1.1-1](#).

Fig. 9.1.1-1 Definition of Supports that are Required to be Assessed

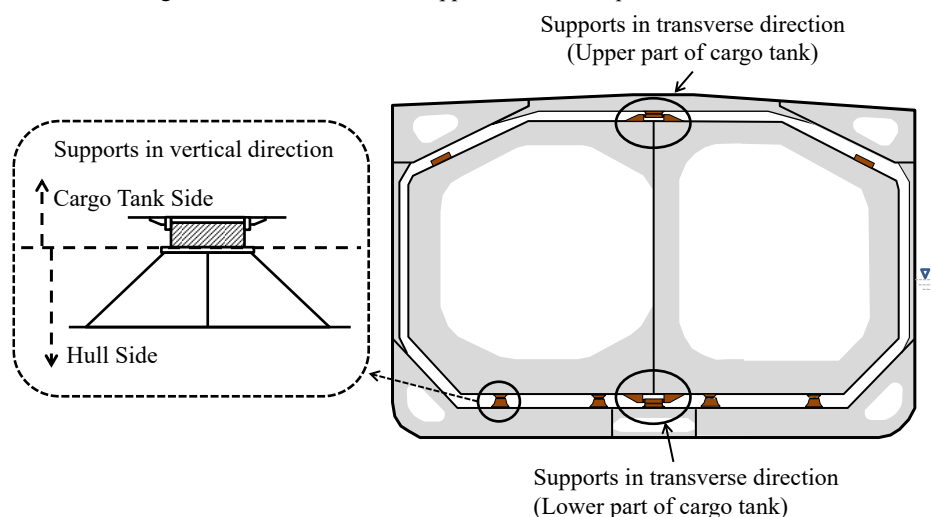

Table 9.1.1-1. Application of Fatigue Strength Assessment to Each Structure

Tank type	Item	Reference rules, etc.
A and B	Fatigue strength assessment of the primary members of the hull structure	This Chapter
A	Fatigue strength assessment of the primary members of the cargo tank structure	This Chapter
B	Fatigue strength assessment of the structural component of cargo tank	4.22.4, Part N
A	Fatigue strength assessment of the primary members of supports	This Chapter
B	Fatigue strength assessment of the primary members of supports (hull side ^(Note 1))	This Chapter
B	Fatigue strength assessment of the primary members of the supports (cargo tank side ^(Note 1))	4.22.4, Part N

Notes:

1: See [Fig. 9.1.1-1](#) for the definitions of the hull side and cargo tank side of supports.

9.1.1.2 Application

Ships with a length L_C of 90 m or more are to be assessed for fatigue strength based on the hot spot stresses obtained by the simple stress analysis according to **9.3, Part 1** and the finite element analysis according to **9.3**.

9.1.2 Assumptions**9.1.2.1**

The following assumptions (1) to (9) are made in the fatigue strength assessment specified in this Chapter.

- (1) A linear cumulative damage model (i.e. Miner's rule) given in **9.5.4, Part 1** is used in the calculation of fatigue damage.
- (2) Fatigue design life T_{FD} is taken not less than 25 years.
- (3) Rule quasi-static wave loads are determined at the 10^{-2} probability level of exceedance by the Equivalent Design Wave (*EDW*) concept.
- (4) Stresses are assessed by the net scantlings t_{n25} , according to **9.3**.
- (5) Hot spot stress is used for fatigue strength assessment of weld toes and the free edge of members, and the effective notch stress is used for fatigue strength assessment of the weld root.
- (6) Excluding exceptional cases, fatigue strength assessment of welds is made for the weld toe. For the welded joints where loads are carried to the weld, the assessment is to be in accordance with **9.1.4.2, Part 1**, **9.1.4.3, Part 1** or **9.6, Part 1**.
- (7) The design $S-N$ curve at two standard deviations below the mean $S-N$ curve is used. The $S-N$ curve in the in-air environment is used for the period when the coating at the location being assessed is effective and the $S-N$ curve in the corrosive environment is used for the period when the effectiveness of the coating is lost.
- (8) The long-term distribution of the stress range for wave loads is assumed to follow an exponential distribution.
- (9) The acceptance criterion for fatigue strength assessment is given in **9.6**.

9.2 Hot Spots to be Assessed**9.2.1 Hot Spots to be Assessed by Finite Element Analysis****9.2.1.1**

1 The hot spots to be assessed for fatigue strength by finite element analysis according to this Chapter are the structural details specified in the column of range 1 in **Tables 9.2.1-1 to 9.2.1-4**.

2 For ships for which the class notation "PS-FA-S" is affixed to classification characters, the structural details of optional items listed in the range 2 column of **Tables 9.2.1-1 to 9.2.1-4** are to be assessed.

3 Notwithstanding the requirement specified in -1, where documents demonstrating sufficient fatigue strength are submitted and deemed appropriate by the Society, the fatigue strength assessment of the structure may be omitted.

4 Assessment is to be carried out for the midship, fore and aft cargo hold parts of the ships.

5 The target hold for fatigue strength assessment is to be the same as that selected for cargo hold analysis according to **8.2.1.1**.

Table 9.2.1-1 Structural Details of Primary Members to be Assessed in the Hull Structure

No.	Critical structural details of hull structure	Range 1	Range 2 (Option)
1	Intersections of bilge hopper plating and girder, floor	×	×
2	Lower (and upper, if necessary) bracket toe of hold frame	×	×
3	Intersections of the bulkhead and inner bottom plating	× ⁽¹⁾	×
4	Dome opening of upper deck (corner part)	×	×
5	Intersections of connection trunk and side shell plating and bilge hopper plating	—	×
6	Intersections of deck girder and deck longitudinal	× ⁽¹⁾	×
Note: (1) Assessment is to be conducted only when the Society determines that fatigue strength is not sufficient.			

Table 9.2.1-2 Additional Assessment Target Structural Details for LNG Carriers

No.	Additional target locations for LNG carriers	Range 1	Range 2 (Option)
7	Intersections of upper knuckle part of bilge hopper plating and horizontal girder, transverses	×	×
8	Knuckle parts of longitudinal bulkhead	—	×

Table 9.2.1-3 Structural Details of Primary Members to be Assessed in the Cargo Tank Structure

No.	Critical structural details of cargo tank structure	Range 1	Range 2 (Option)
9	Intersections of bracket ends of horizontal girder and centreline bulkhead	—	×
10	Intersections of bottom transverses and centreline bulkhead	—	×
11	Bracket toe of swash bulkheads	—	×
12	Intersections of tank bottom longitudinal frames and tripping brackets fitted with bottom transverses	—	×

Table 9.2.1-4 Structural Details of Primary Members to be Assessed in Supports

No.	Critical structural details of supports	Range 1	Range 2 (Option)
13	Bracket toe of supports in vertical supports	— ⁽²⁾	×
14	Bracket toe of upper part of supports in transverse direction	— ⁽²⁾	×
15	Bracket toe of lower part of supports in transverse direction	— ⁽²⁾	×
16	Connection part of tripping bracket fitted with deck transverse (being member of supports in transverse direction) and deck longitudinal	× ⁽¹⁾	×
Notes:			
(1)	Assessment is to be conducted only when the Society determines that fatigue strength is not sufficient.		
(2)	If 1.2 is used in the application of C_{fa} specified in 8.6.5.2, assessment is to be conducted.		

9.3 Loading Conditions and Fraction of Time to be Considered

9.3.1 General

9.3.1.1

1 Standard loading conditions and fraction of time are to be in accordance with [Table 9.3.1-1](#) according to the target structure to be assessed.

2 Notwithstanding the requirements specified in -1, when considering loading conditions and fraction of time other than those in [Table 9.3.1-1](#) to [Table 9.3.1-5](#), it is necessary to consider appropriate combinations.

Table 9.3.1-1 Standard Loading Conditions and Fraction for the Assessment of Hull Structure

Loading condition	Fraction of time $\alpha_{(j)}$
Full load condition (homogeneous loading)	50 %
Ballast condition	50 %

Table 9.3.1-2 Standard Loading Conditions and Fraction for the Assessment of Cargo Tank Structure

Loading condition	Fraction of time $\alpha_{(j)}$
Full load condition (homogeneous loading)	50 %

Table 9.3.1-3 Standard Loading Conditions and Fraction for the Assessment of Structural Details on the Hull Side of Supports in Vertical Direction

Loading condition	Fraction of time $\alpha_{(j)}$
Full load condition (homogeneous loading)	50 %
Ballast condition	50 %

Table 9.3.1-4 Standard Loading Conditions and Fraction for the Assessment of Structural Details on the Cargo Tank Side of Supports in Vertical Direction

Loading condition	Fraction of time $\alpha_{(j)}$
Full load condition (homogeneous loading)	50 %

Table 9.3.1-5 Standard Loading Conditions and Fraction for the Assessment of Structural Details of Supports in Transverse

Direction	
Loading condition	Fraction of time $\alpha_{(j)}$
Full load condition (homogeneous loading)	50 %

9.4 Finite Element Analysis

9.4.1 General

9.4.1.1 General

The requirements of the evaluation method for hot spot stresses of connection of platings and girders, and the free edges of base materials by very fine finite element analysis is specified in 9.4. The hot spot stress takes into account structural discontinuities due to the structural details of joints but does not consider local stress concentrations due to the presence of welds.

9.4.1.2 Confirmation of Calculation Method and Accuracy of Analysis

The analysis method and analysis program are to be in accordance with 9.4.1.2, Part 1.

9.4.1.3 Strength Assessment Based on Advanced Analysis

In the application of 9.4, the strength assessment based on an advanced analysis, such as direct load analysis, may be conducted when deemed appropriate by the Society. However, when the hot spot stress is calculated from the stress obtained by the analysis, no other methods than those specified in 9.4 are to be adopted.

9.4.1.4 Types of Hot Spot Stresses

The types of hot spot stresses are in accordance with 9.4.1.4, Part 1.

9.4.2 Finite Element Method

9.4.2.1 General

1 The standard method for evaluation of hot spot stresses for fatigue strength assessment is to incorporate very fine finite element mesh zones for areas of high stress concentration into the global model.

2 The coarse mesh model of the cargo holds is to be made according to 8.3. Alternatively, this very fine mesh analysis can be carried out by means of separate local finite element models with very fine mesh zones in conjunction with the boundary conditions obtained from a global model of the cargo holds. In this case, the corrosion deductions of the global model of the cargo holds are to be in coincidence with those of the local finite element model.

9.4.2.2 Extent of Modelling, Members to be Modelled, Corrosion Model, Mesh Size and Note on Modelling

Extent of modelling, members to be modelled, corrosion model, mesh size, and note on modelling is to be in accordance with 9.4.2.2, 9.4.2.3, 9.4.2.5, 9.4.2.7 and 9.4.2.8, Part 1.

9.4.2.3 Types of Elements

1 The types of elements used for modelling is to be in accordance with the following (1) to (4):

- (1) Plating and girders are to be modelled using shell elements.
- (2) Stiffeners, the face plates of primary supporting members and the face plates of brackets in the very fine mesh zone are to be modelled using shell elements.
- (3) In principle, stiffeners outside the very fine mesh zone are to be modelled using beam elements and the eccentricity of the neutral axis is to be considered.
- (4) Face plates of primary supporting members and of brackets outside the very fine mesh zone are to be modelled using rod elements or beam elements.
- (5) Solid elements are to be used to represent bearing blocks inserted into the contact surfaces.

2 For the characteristics of the elements, refer to 8.3.2.1.

9.4.2.4 Note for Modelling Especially for Ships Carrying Liquefied Gases in Bulk (Independent Prismatic Tanks Type A/B)

1 Stiffness of supports in coarse mesh model is to be reproduced the same as far as possible with the stiffness values in fine mesh

model as well as real construction. Stiffness in the normal direction to each contact surface requires particular care for accuracy in this respect.

2 Density of cargo tank steel is to be adjusted accordingly to consider the additional masses coming from primary fittings not being modelled such as piping, pumps, insulation materials.

3 Shell elements, not rod or beam elements, are to be used when modelling members located near supports such as tripping brackets, etc.

4 Modelling of coamings in upper deck for tank dome openings are to be precise as possible.

9.4.3 Contacts and Frictions

9.4.3.1 Settings to Consider the Contacts and Frictions

Settings for considering contact and friction is to be in accordance with [8.3.4.1](#).

9.4.3.2 Friction Force Generated Between a Cargo Tank and Various Supports

1 Magnitude of friction force considered is to be determined appropriately with the upper limit which is the reaction force generated by each support multiplied by the friction coefficient μ .

2 Friction coefficients for combination of contact surfaces of representative materials are given in [Table 9.4.3-1](#). the value other than those found in [Table 9.4.3-1](#) may be used in case where relevant documents justifying the adequacy of its use are to be submitted to the Society and approved by the Society.

Table 9.4.3-1 Typical Frictional Coefficients μ

Combination of materials used		Frictional coefficient μ
Material 1	Material 2	
Steel	Wood	0.2
Steel	Resin	0.2

9.4.3.3 Factors to be Considered Regarding Very Fine Mesh Analysis

Consideration is to be given to the following (1) and (2) items when carrying out very fine mesh analysis.

- (1) Reaction force distribution which may be generated on the contact surfaces between cargo tanks and their various supports (See [Fig. 9.4.3-1](#))
- (2) Design friction force which may be generated on the contact surface between cargo tanks and their various supports

9.4.3.4 Analysis Cases

For each selected support, analyses are to be carried out for Case A in accordance with [Table 9.4.3-2](#).

Case A: Analysis to investigate responses against naturally occurring (for each particular load case applied) friction/ direction and reaction force with uneven distribution over the contact surface. This is normally realized by using internal models consisting of hull and cargo tank structures. (See [Fig. 9.4.3-2](#))

Table 9.4.3-2 Analysis Cases to Consider when Assessing Supports

Types of supports	Load scenario	Analysis case	Design reaction force and friction force
Vertical direction	Seagoing conditions	Case A	Table 9.4.3-3
Transverse direction	Seagoing conditions	Case A	Table 9.4.3-3

Fig. 9.4.3-1 Example of Reaction Force Distribution for Contact Surface

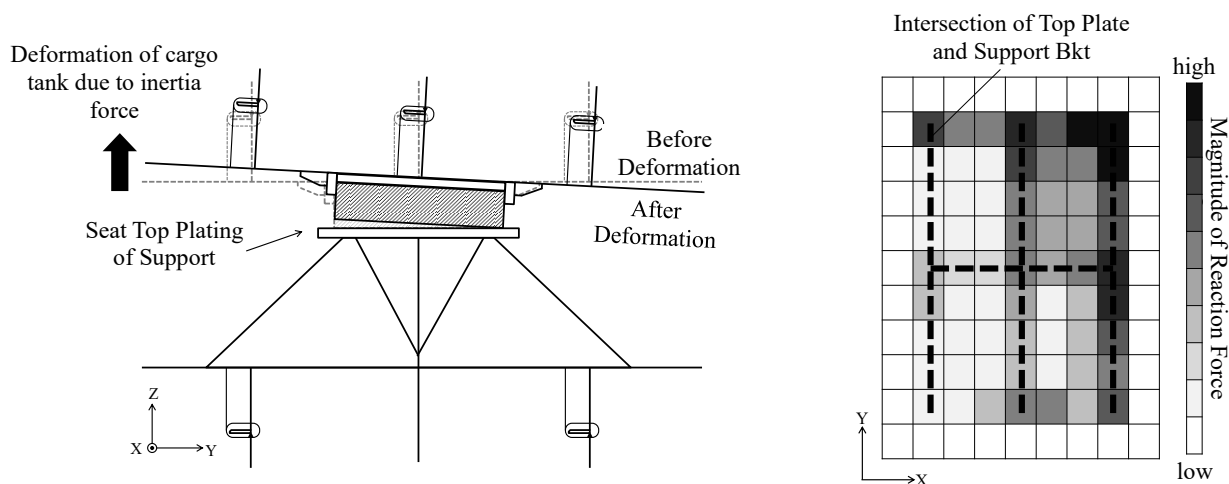

Fig. 9.4.3-2 Example of Analysis Model of Case A

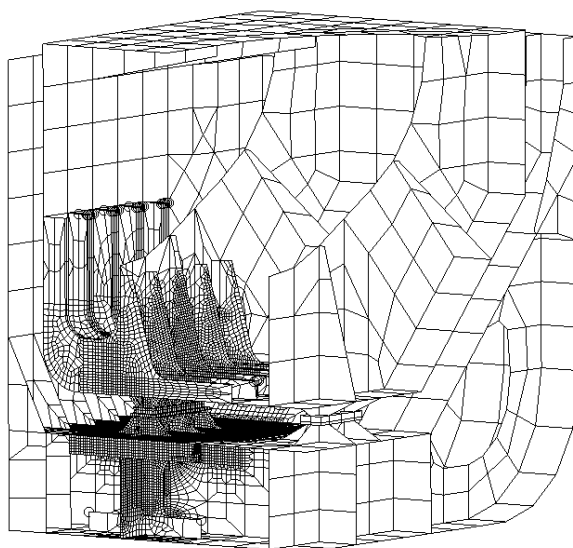

Table 9.4.3-3 Design Reaction Forces and Design Friction Forces Considered in Case A

Support type	Designed reaction force			Designed friction force		
	Magnitude		Distribution	Magnitude	Distribution	Direction
	Maximum design reaction forces	gap effect Consideration				
Vertical direction	R_z	None	Automatically considered during analysis	$\mu \cdot R$ Upper limit of the friction force obtained by the above formula (friction force \times design reaction force). Automatically considered during analysis.	Automatically considered during analysis	
Transverse direction	R_y	None				

9.5 Boundary Conditions and Load Conditions

9.5.1 Boundary Conditions

9.5.1.1

In applying [9.4.4.1, Part 1](#), the boundary conditions are to be in accordance with [8.4.1, Part 2-8](#).

9.5.2 Load Conditions

9.5.2.1 Method of Applying Moments to the Structural Model

In applying [9.4.4.2, Part 1](#), the method of applying moments to the structural model is to be in accordance with [8.4.2.2, Part 2-8](#). However, the vertical bending moment and horizontal bending moment ($kN\cdot m$) specified in [Table 9.5.2-1](#) are to be used as M_{V-targ} , M_{H-targ} instead of that specified in [Table 8.4.2-1, Part 2-8](#).

Table 9.5.2-1 M_{V-targ} and M_{H-targ}

	Cyclic load condition
Vertical bending moment M_{V-targ}	M_{V-HG}
Horizontal bending moment M_{H-targ}	M_{H-HG}
Notes: M_{V-HG} , M_{H-HG} : Vertical bending moment and horizontal bending moment ($kN\cdot m$) under cyclic load conditions, to be in accordance with 4.7.2.10, Part 1 .	

9.6 Fatigue Strength Assessment

9.6.1 General

9.6.1.1

1 Fatigue strength assessment is to be in accordance with [9.5, Part 1](#).

2 Notwithstanding the requirement in -1 above, the fatigue strength assessment criteria is to be in accordance with the following formula:

$$\eta \cdot C_{ST} \cdot D \leq 1.0$$

η : Correction factor of fatigue damage based on fatigue load used in the assessment, as given in [Table 9.5.5-1, Part 1](#).

C_{ST} : Correction coefficient of fatigue damage, to be obtained from the followings according to the assessment target.

For hull structure, cargo tank structure, supports in vertical direction and supports in transverse direction

(upper part of cargo tank): 1.0

For supports in transverse direction (lower part of cargo tank): 1.1

Chapter 10 ADDITIONAL STRUCTURAL REQUIREMENTS

10.1 Tank Structures for Sloshing

10.1.1 General

10.1.1.1 Application

1 For the members of cargo tank structures of independent prismatic tanks type A/B which satisfy the following (1) to (3), the scantlings specified in this 10.1 are considered to be satisfied when obtained using the sloshing loads specified in 4.8.2.4, Part 1.

- (1) Independent prismatic tanks with volumes of not less than 100 m^3
- (2) Independent prismatic tanks designed for possible to loading at filling ratios of not less than 20 % and not more than 90 %
- (3) Where the period of longitudinal oscillation of independent prismatic tanks is within the range of ± 20 % of pitch period and within ± 1.5 seconds from the same period, and where the period of transverse oscillation of independent prismatic tanks is within the range of ± 20 % of roll period and within ± 1.5 seconds from the same period.

2 In applying -1(3) above, where only one of the conditions is applicable, only the sloshing load due to the relevant ship motion need be considered.

3 In applying -1(3) above, tank natural periods are to be calculated for each 10 % of the filling ratio, and only the sloshing load due to the filling ratio corresponding to the conditions of -1(3) above need be considered.

10.1.1.2 Scantling Approach

The required scantlings specified in this 10.1 are to be net scantlings. Corrosion additions for independent prismatic tanks are to be in accordance with 3.3.4.3, Part 1.

10.1.2 Plates

10.1.2.1 Tank Type A

The thickness of plates on which sloshing loads act is to be not less than the value obtained from the following formula.

$$t = \frac{b}{2} \sqrt{\frac{P_{slh} \times 10^{-3}}{1.15 C_a \sigma_{perm}}} \text{ (mm)}$$

b : Length (mm) of the shorter side of the plate panel.

P_{slh} : Equivalent pressure (kN/m^2) for the plate panels, as specified in Table 10.1.2-1.

C_a : Coefficient of axial force effect, to be taken as 1.0.

σ_{perm} : Permissible stress (N/mm^2), as specified in Table 10.1.2-2.

Table 10.1.2-1 Equivalent Pressure for Plate Panels

Member to be assessed	P_{slh}
<ul style="list-style-type: none"> - Front and aft walls of tank - Transverse wash bulkheads - Tank top plates near front and aft walls of tank⁽¹⁾ 	P_{slh-p} (4.8.2.4-4(1), Part 1)
<ul style="list-style-type: none"> - Tank side walls - Centreline bulkheads - Longitudinal wash bulkheads - Tank top plates near tank side walls⁽¹⁾ - Sloping plates above and below tank side walls⁽²⁾ 	P_{slh-r} (4.8.2.4-4(2), Part 1)
Notes:	
Numbers in parentheses indicate section number.	
(1) P_{slh-p} applies to plate panels within the range of $0.3\ell_{tk}$ from the front and aft walls of tanks, while P_{slh-r} applies to plate panels within the range of $0.3b_{tk}$ from centreline bulkheads / tank side walls. Definitions of ℓ_{tk} and b_{tk} are specified in Table 4.8.2-13, Part 1 and Table 4.8.2-14, Part 1 .	
(2) Notwithstanding (1) above, where large sloping plates are arranged between tank top plates and tank side walls, tank top plates may be excluded from the members to be assessed.	

Table 10.1.2-2 Permissible Stress (Tank Type A)

Member	σ_{perm}
- Ferrite steels	min (0.79 σ_Y , 0.53 σ_B)
Notes:	
σ_Y :Specified minimum yield stress (N/mm ²)	
σ_B :Specified minimum tensile stress at room temperature (N/mm ²), to be taken as:	
For KL24, taken as 400	
For KL27, taken as 420	
For KL33, taken as 440	
For KL37, taken as 490	

10.1.2.2 Tank Type B

The thickness of plates on which sloshing loads act is to be not less than the value obtained from the formula specified in **10.1.2.1**. However, permissible stress σ_{perm} (N/mm²) is to be in accordance with **Table 10.1.2-3**.

Table 10.1.2-3 Permissible Stress (Tank Type B)

Member to be assessed	σ_{perm}
- Nickel steels, carbon manganese steels	min (0.83 σ_Y , 0.5 σ_B)
- Austenitic steels and aluminum alloys	min (0.83 σ_Y , 0.4 σ_B)
Notes:	
σ_Y , σ_B : As specified in Table 10.1.2-2	

10.1.3 Stiffeners

10.1.3.1

The section modulus of stiffeners attached to plates on which sloshing loads act is to be not less than the value obtained from the following formula.

$$Z = \frac{M_{slh}}{C_s \sigma_{perm}} \times 10^3 (cm^3)$$

M_{slh} : Equivalent bending moment ($kN-m$), as specified in [Table 10.1.3-1](#).

C_s : Coefficient of axial force effect, to be taken as 1.0.

σ_{perm} : Permissible stress (N/mm^2), as specified in [Table 10.1.2-2](#) or [Table 10.1.2-3](#).

Table 10.1.3-1 Equivalent Bending Moment for Each Member to be Assessed

Member to be assessed	Stiffened system	M_{slh}
- Stiffeners attached to tank top plates ⁽¹⁾⁽²⁾	Longitudinal	M_{slh-p} (4.8.2.4-5(1), Part 1) M_{slh-r} (4.8.2.4-5(2), Part 1)
	Transverse	M_{slh-p} (4.8.2.4-5(2), Part 1) M_{slh-r} (4.8.2.4-5(1), Part 1)
- Stiffeners attached to front and aft walls of tank - Stiffeners attached to transverse wash bulkheads - Stiffeners attached to vertical girders which are attached to centreline bulkheads - Stiffeners attached to vertical girders which are attached to tank side walls - Stiffeners attached to horizontal girders which are attached to front and aft walls of tank - Stiffeners attached to cross-tie of transverse direction	System A ⁽³⁾	M_{slh-p} (4.8.2.4-5(1), Part 1)
	System B ⁽⁴⁾	M_{slh-p} (4.8.2.4-5(2), Part 1)
- Stiffeners attached to tank side walls - Stiffeners attached to longitudinal wash bulkheads - Stiffeners attached to sloping plates above and below tank side walls - Stiffeners attached to vertical girders which are attached to front and aft walls of tank - Stiffeners attached to horizontal girders which are attached to tank side walls - Stiffeners attached to horizontal girders which are attached to centreline bulkheads	System A ⁽²⁾	M_{slh-r} (4.8.2.4-5(1), Part 1)
	System B ⁽³⁾	M_{slh-r} (4.8.2.4-5(2), Part 1)
Notes:		
Numbers in parentheses indicate section number.		
(1) M_{slh-p} applies to stiffeners attached to plate panels within the range of $0.3\ell_{tk}$ from the front and aft walls of tanks, while M_{slh-r} applies to stiffeners attached to plate panels within the range of $0.3b_{tk}$ from centreline bulkheads / tank side walls. Definitions of ℓ_{tk} and b_{tk} are specified in Table 4.8.2-13 and Table 4.8.2-14, Part 1 .		
(2) Notwithstanding (1) above, where large sloping plates are arranged between tank top plates and tank side walls, stiffeners attached to the tank top plates may be excluded from the members to be assessed.		
(3) See Fig. 10.9.3-1, Part 1		
(4) See Fig. 10.9.3-2, Part 1		

10.1.4 Webs of Girders

10.1.4.1

The web thickness t_w for girders on which sloshing loads act is to be not less than the value obtained from the following formula.

$$t_w = \frac{b}{2} \sqrt{\frac{P_{slh} \times 10^{-3}}{1.15 C_a \sigma_{perm}}} (mm)$$

P_{slh} : Equivalent pressure (kN/m^2) for plate panels, as specified in [Table 10.1.4-1](#)

C_a : Coefficient of axial force effect, to be taken as 1.0

b : Length (mm) of the shorter side of the plate panel

σ_{perm} : Permissible stress (N/mm²), as specified in [Table 10.1.2-2](#) or [Table 10.1.2-3](#)

Table 10.1.4-1 Equivalent Pressure for Each Member to be Assessed

Member to be assessed	P_{sth}
<ul style="list-style-type: none"> - Horizontal girders attached to front and aft walls of tanks / transverse wash bulkheads - Vertical girders attached to tank side walls / centreline bulkheads / longitudinal wash bulkheads - Cross-ties in transverse direction 	P_{sth-p} (4.8.2.4-4(1), Part 1)
<ul style="list-style-type: none"> - Horizontal girders attached to tank side walls / centreline bulkheads / longitudinal wash bulkheads - Vertical girders attached to front and aft walls of tanks / transverse wash bulkheads - Cross-ties in longitudinal direction 	P_{sth-r} (4.8.2.4-4(2), Part 1)
<p>Note: Numbers in parentheses indicate section number.</p>	

Part 2-10 SHIPS CARRYING LIQUEFIED GASES IN BULK (INDEPENDENT TANKS OF TYPE C)

Chapter 1 GENERAL

1.1 General

1.1.1 Application

1.1.1.1 Application of this Part

1 The hull construction and equipment of ships intended to be registered as ships with independent tanks of type C carrying liquefied gases in bulk, affixed with the notation “*Independent Tanks of Type C*” (abbreviated as *IT Type C*), are to be in accordance with the requirements in **Part 2-10** in addition to **Part 1**.

2 The requirements in **Part 2-10** are generally for ships with independent tanks of type C carrying liquefied gases in bulk, having double bottoms and a single deck in longitudinal framing systems.

3 Ships with independent tanks of type C carrying liquefied gases in bulk with a different construction from that specified in -2 above, to which the requirements in this Part are considered to be not applicable, are to be at the discretion of the Society.

1.2 Definitions

1.2.1 Terms

1.2.1.1 Definition of Terms

“Independent tank of type C” refers to a tank that complies with the requirements of **10.5, Part D**.

1.2.2 Naming Convention

1.2.2.1 Structural Nomenclature

Fig. 1.2.1-1 show the common structural nomenclature used in **Part 2-10**.

Fig. 1.2.1-1 Ships Carrying Liquefied Gases in Bulk (Independent Tanks of Type C)

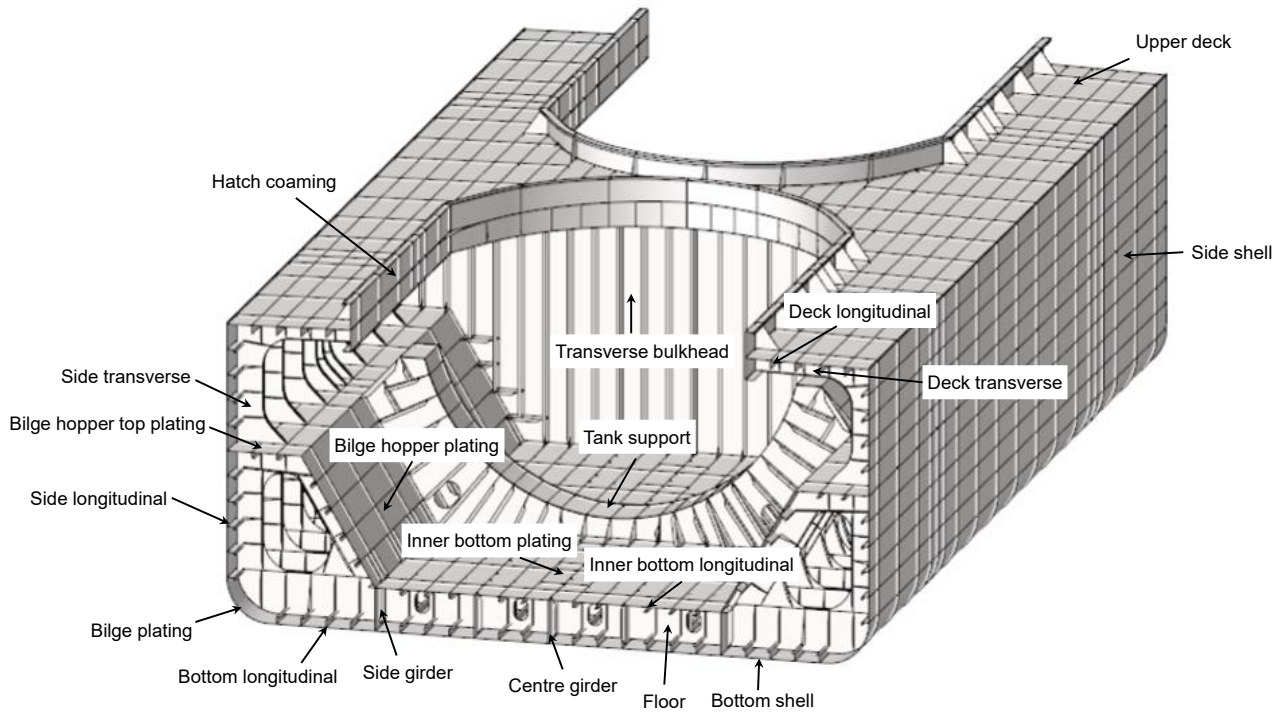

Chapter 4 LOADS

4.1 General

4.1.1 Overview

4.1.1.1 Structure and Overview of this Chapter

Each section of this Chapter defines the additional requirements shown in [Table 4.1.1-1](#) as the loads used for each formula and each strength assessment to determine the scantlings specified in each Chapter of [Part 2-10](#) and [Part 1](#).

Table 4.1.1-1 Overview of Chapter 4

Section	Title	Overview
4.1	General	Requirements for the general principles of Chapter 4
4.2	Loads to be Considered in Local Strength	Additional requirements for loads to be considered for the local strength requirements specified in Chapter 6, Part 1 .
4.3	Loads to be Considered in Strength of Primary Supporting Structures	Additional requirements for loads to be considered for the requirements of strength of primary supporting structures specified in Chapter 7 and Chapter 7, Part 1 .

4.2 Loads to be Considered in Local Strength

4.2.1 General

4.2.1.1 General

1 The loads to be considered in the requirements of local strength specified in [Chapter 6, Part 1](#) are also to be in accordance with the requirements of [4.2](#).

2 Additional requirements for loads in the maximum load condition are to be in accordance with the requirements of [4.2.2](#).

4.2.2 Maximum Load Condition

4.2.2.1 Lateral Loads

In applying [4.4.2, Part 1](#), the parameters (GM , z_G etc.) required to calculate the dynamic pressure due to ballast water are to be the values in the ballast condition. The same parameters are to be applied where the dynamic pressure due to liquid other than ballast water, such as the pressure due to fuel oil tank, is calculated.

4.3 Loads to be Considered in Strength of Primary Supporting Structures

4.3.1 General

4.3.1.1 General

1 The loads to be considered in the requirements of strength of the primary supporting structures specified in [Chapter 7](#) and [Chapter 7, Part 1](#) are to be in accordance with the requirements of [4.3](#).

2 Additional requirements for loads in the maximum load condition are to be in accordance with the requirements of [4.3.2](#).

3 The loads in the harbour condition may not be considered.

4.3.2 Maximum Load Condition

4.3.2.1 General

1 The requirements for simple girders are also to be in accordance with the relevant requirements of [4.2](#).

2 For the requirements of double hull, the loads specified in [Table 4.3.2-1](#) are to be considered. Where deemed necessary by the

Society, additional loading patterns which is taken into account the loading conditions described in the loading manual may be required.

Table 4.3.2-1 Loads to be Considered in Maximum Load Condition

Structure to be assessed		Loading pattern ⁽¹⁾			Equivalent design wave	Difference between external and internal pressure to be considered (kN/m^2)
		Draught (m)	Vertical still water bending moment ($kN\cdot m$)	Loaded to be considered		
Double bottom	S1	T_{SC}	$M_{SV\ max}$	None	HM-2	Double bottom : P_{DB}
	S2	T_{SC}	$M_{SV\ min}$	None	HM-1	Double side : P_{DS}

4.3.2.2 External Pressure

For the requirements of double hull, the hydrostatic pressure and the hydrodynamic pressure at the equivalent design wave specified in [Table 4.3.2-2](#), are to be considered.

Table 4.3.2-2 External and Internal Pressure to Be Considered

		$P_{DB}(kN/m^2)^{(1)\ (2)}$	$P_{DS}(kN/m^2)^{(1)\ (2)}$
Double bottom	S1	$P_{exs} + P_{exw}$	$P_{exs} + P_{exw}$
	S2	$P_{exs} + P_{exw}$	$P_{exs} + P_{exw}$
Notes:			
P_{exs}, P_{exw} : Hydrostatic and Hydrodynamic pressure (kN/m^2) act on bottom shell in case of P_{DB} . Those values act on side shell in case of P_{DS} . Each value is calculated in accordance with 4.6.2.4, Part 1 .			
(1) Load calculation points for calculating each component of loads such as P_{exs} are to be in accordance with 7.3.1.5, Part 1 for all loading conditions.			
(2) When calculating loads, $T_{LC} = T_{SC}$.			
(3) P_{exw} is to be not less than the value of P_{exw} for HM-2 at x_G , which is the X coordinate (m) at the centre of gravity of the ship.			

4.3.2.3 Vertical Bending Moment

1 For the requirements of double hull, the vertical still water bending moment and the vertical wave bending moment in the equivalent design wave specified in [4.3.2.1-2](#) are to be considered.

2 The vertical wave bending moment under consideration for each equivalent design wave is to be in accordance with [4.6.2.10, Part 1](#).

Chapter 5 LONGITUDINAL STRENGTH

5.1 Hull Girder Ultimate Strength

5.1.1 Strength Criteria

5.1.1.1 Effect of Double Bottom Bending

In the assessment decision specified in [5.4.2.2 in Part 1](#), the coefficient γ_{DB} that takes into account the effect of double bottom bending is as follows.

$$\gamma_{DB} = 1.15$$

Chapter 7 STRENGTH OF PRIMARY SUPPORTING STRUCTURES

7.1 General

7.1.1 Application

7.1.1.1

For the double bottom and double-side skin structure, the requirements of the double hull structure specified in **7.3, Part 1** are to be applied. For other girder members that can be regarded as simple girders, the requirement of the simple girder specified in **7.2, Part 1** are to be applied.

7.1.1.2 Application Example of Assessment Model for Liquefied Gas Bulk Carriers with Independent Tanks Type C

1 An application example of assessment model applying **7.2** and **7.3, Part 1** is shown in **Fig. 7.1.1-1**.

2 For girder members deemed to be simple girders with structures different from that shown in **Fig. 7.1.1-1**, the boundary conditions and acting loads are to be considered, and the assessment model from **Table 7.2.1-2, Part 1** is to be appropriately selected.

Fig. 7.1.1-1 Application Example of Liquefied Gas Bulk Carriers with Independent Tanks Type C

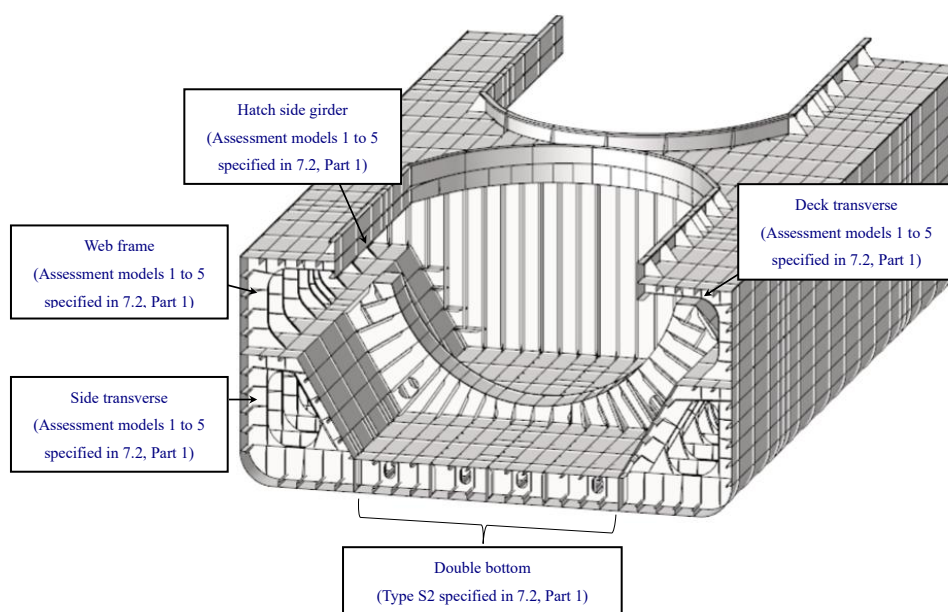

Note:

Where bottom structure is single bottom, **7.2** is to be applied.

3. 7.2 General

7.2.1 Application

7.2.1.1

Where the ship is single bottom and the aspect ratio ℓ_H/B_H is 2.0 or more, to be in accordance with **7.2.2**. ℓ_H and B_H are defined in **Fig. 7.2.1-1**. Where the aspect ratio is small, it is to be as deemed appropriate by the Society.

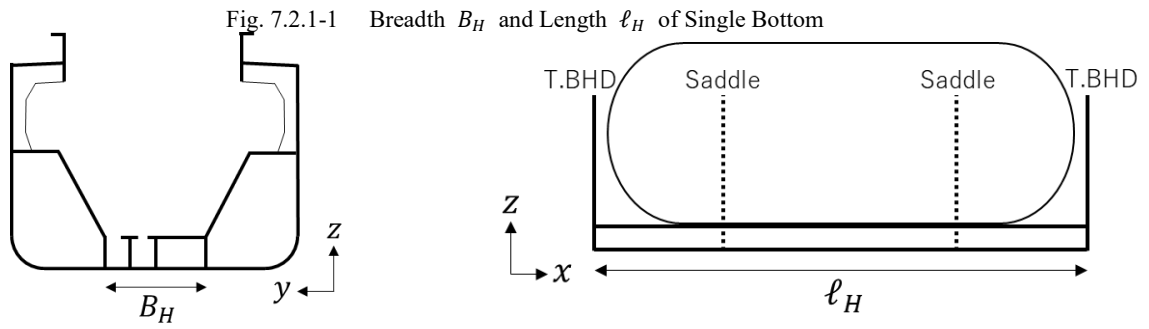

7.2.2 Evaluation Members to be Assessed

7.2.2.1 Floors

Strength assessments are to be carried out in accordance with the requirements for simple girders specified in [7.2 of Part 1](#).

The full length ℓ of the floor is to be B_H shown in [Fig. 7.2.1-1](#).

7.2.2.2 Girders

Girder scantlings are to be of the same degree as floor scantlings.

Chapter 8 STRENGTH ASSESSMENT BY CARGO HOLD ANALYSIS

8.1 General

8.1.1 Application

8.1.1.1

Ships corresponding to **8.1.2.1-1(2), Part 1** are to be ships having a cargo hold with a length of 30 *m* or more.

8.1.2 Members to be Assessed

8.1.2.1

In applying **8.2.2, Part 1**, the members forming the cargo tank structures may not be assessed.

8.1.3 Structural Models

8.1.3.1 Members to be Modelled

In applying **8.3.1.2, Part 1**, the cargo tank structures and the cargo tank supporting structures are to be modelled appropriately.

8.1.3.2 Properties of Elements

In applying **8.3.2.2, Part 1**, where the equipment such as cargo pumps or pipes and insulation are not modelled, the density of material at locations where the cargo tank structures are modelled is to be adjusted in consideration of their weight.

Part 2-11 SHIPS CARRYING LIQUEFIED GASES IN BULK (MEMBRANE TANKS)

Chapter 1 GENERAL

1.1 General

1.1.1 Application

1.1.1.1 Application of this Part

1 The hull construction and equipment of ships intended to be registered as ships with membrane tanks carrying liquefied gases in bulk, affixed with the notation “*Membrane Tanks*” (abbreviated as *MT*), are to be in accordance with the requirements in **Part 2-11** in addition to **Part 1**.

2 The requirements in **Part 2-11** are generally for ships with membrane tanks carrying liquefied gases in bulk, having double bottom structure, bilge hopper tanks, double side structure, and double deck structure in longitudinal framing systems.

3 Ships with membrane tanks carrying liquefied gases in bulk with a different construction from that specified in -2 above, to which the requirements in this Part are considered to be not applicable, are to be at the discretion of the Society.

1.1.1.2 Relationship with Other Rules of the Society*

In applying **1.2.2.5, Part 1**, the relevant requirements specified in **Part N** are shown for the reference.

Table 1.1.1-1 Relationship with the Other Rules

Structures	Items	Relevant rules, etc. other than Part C
Hull structures	Applications of steels	4.19.1, Part N and Chapter 6, Part N
Membrane tanks	Membrane containment system assessments	Requirements of system designers
	Fatigue strength assessments	4.24.6, Part N
	Crack propagation evaluations	4.24.6, Part N
	Sloshing evaluation (within allowable filling levels)	4.14.3, Part N
	Thermal stress analysis (considering transient condition for cargo temperature below -55°C)	4.13.4, Part N

1.2 Definitions

1.2.1 Terms

1.2.1.1 Definition of Terms

1 “Membrane tanks” are non-self-supporting tanks that consist of a thin liquid and gastight layer (membrane) supported through insulation by the adjacent hull structure.

2 “System designers” means the designers of membrane cargo containment systems.

1.2.2 Naming Convention

1.2.2.1 Structural Nomenclature

Fig. 1.2.2-1 show the common structural nomenclature used in **Part 2-11**.

Fig. 1.2.2-1 Ships Carrying Liquefied Gases in Bulk (Membrane Tanks)

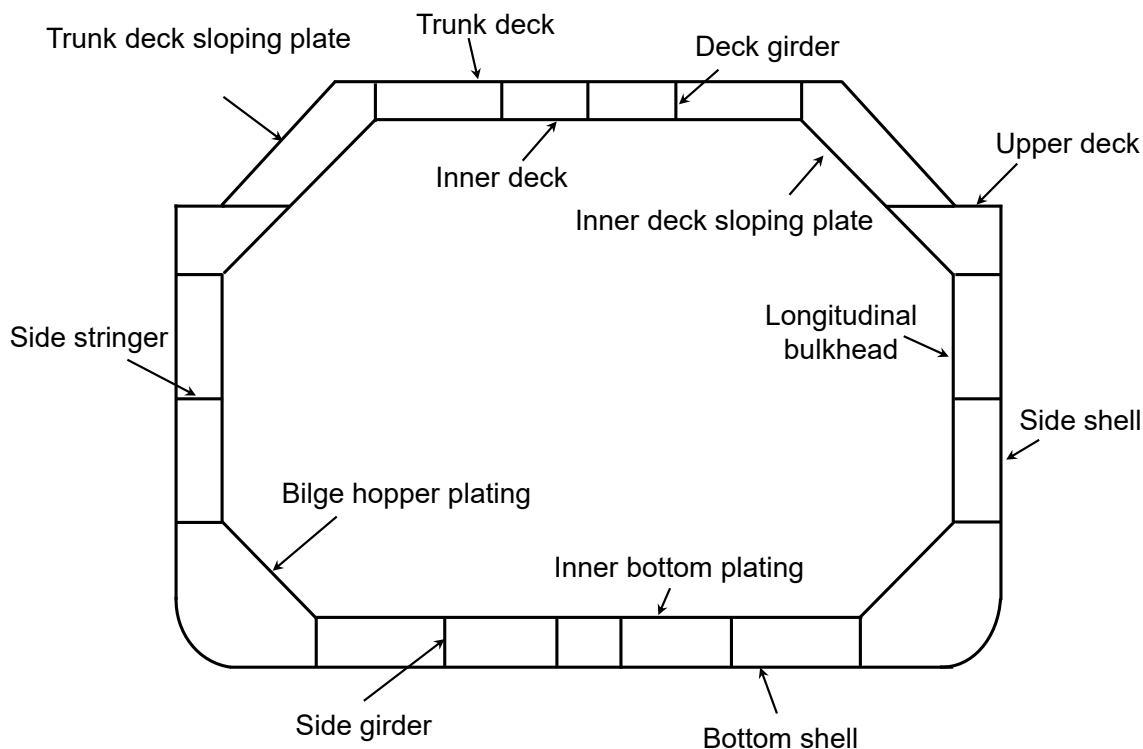

1.3 Plans and Documents To Be Submitted

1.3.1 General

1.3.1.1

In the application of **Chapter 8** and **Chapter 9** in this Part, the following documents are to be submitted to the Society:

- (1) Trim, longitudinal strength and stability calculation sheets listing the operational loading conditions (including any limitations related to such loading conditions)
- (2) Documents containing the following information in the application of **Chapter 8**
 - (a) Software used for direct load analysis if applicable
 - (b) Calculation condition and results for direct load analysis if applicable
 - (c) Analytical loading conditions (including parameters such as draught, still water vertical bending moment, etc.)
 - (d) Location of the centre of gravity of each tank
- (3) Documents containing the following information in the application of **Chapter 9**
 - (a) Documentation containing information as specified in (2)(a) to (d) above
 - (b) Procedures for selection of locations for fatigue strength assessment

Chapter 3 STRUCTURAL DESIGN PRINCIPLES

3.1 Loading Manual and Loading Instruments

3.1.1 Loading Manual

3.1.1.1 Additional Requirements for the Loading Manual

In applying **3.8.2.1-3, Part 1**, the loading manual is to include the following items as operational limitations.

- (1) Where, of the loading conditions considered in strength assessment by the cargo hold analysis specified in **Chapter 8**, one cargo tank is empty (one-tank-empty condition) and strength assessment is performed with ballast tanks adjacent to the empty cargo tank as fully loaded, the said ballast tanks are to be fully loaded under the loading conditions in the loading manual that corresponds to the one-tank-empty condition.
- (2) Of the loading conditions corresponding to the one-tank-empty conditions considered in strength assessment by the cargo hold analysis specified in **Chapter 8**, the designed maximum and minimum draught values specified by the designer
- (3) When designing assuming one and/or a few cargo tanks be empty, the designed position of the empty cargo tanks and its combinations, etc.

Chapter 4 LOADS

4.1 General

4.1.1 Overview

4.1.1.1 Structure and Overview of this Chapter

Each section of this Chapter specifies the additional requirements shown in **Table 4.1.1-1** as the loads used for each formula and each strength assessment to determine the scantlings specified in each Chapter of **Part 2-11** and **Part 1**.

Table 4.1.1-1 Overview of Chapter 4

Section	Title	Overview
4.1	General	Requirements for the general principles of Chapter 4
4.2	Loads to be Considered in Local Strength	Additional requirements for loads to be considered in the local strength requirements specified in Chapter 6 and Chapter 6, Part 1 .
4.3	Loads to be Considered in Strength Assessment by Cargo Hold Analysis	Additional requirements for loads to be considered in the requirements for strength assessment by cargo hold analysis specified in Chapter 8 and Chapter 8, Part 1 .
4.4	Loads to be Considered in Fatigue	Additional requirements for loads to be considered in the fatigue strength assessment requirements specified in Chapter 9 and Chapter 9, Part 1 .
4.5	Loads to be Considered in Additional Structural Requirements	Requirements for loads to be considered in the additional structural requirements specified in Chapter 10 .

4.1.2 Design Load Scenarios and Loads to be Considered

4.1.2.1

In addition to the requirements of **4.1.2.1, Part 1**, the design load scenarios and loads in the following (1) and (2) are to be considered in accordance with the requirements of this Chapter.

- (1) 30-degree static heel condition: Lateral loads due to seawater and cargo where the ship is heeled at 30 degrees (Relevant requirements: **4.13.9, Part N**)
- (2) Collision condition: Lateral loads may be due to seawater and cargo in the condition where the ship collides (Relevant requirements: **4.15.1, Part N**)

4.2 Loads to be Considered in Local Strength

4.2.1 General

4.2.1.1 General

1 The loads to be considered in the requirements of local strength specified in **Chapter 6** and **Chapter 6, Part 1** are also to be in accordance with the requirements of **4.2**.

2 Additional requirements for loads in the maximum load condition are to be in accordance with the requirements of **4.2.2**.

4.2.2 Maximum Load Condition

4.2.2.1 Lateral Loads

1 In applying **4.4.2.4, Part 1**, the parameters (GM , z_G , etc.) required to calculate the dynamic pressure due to cargo are to be the

values in the loading condition that cargo is loaded only in the cargo hold to be considered and the draught is at a minimum (e.g. one-tank-loaded condition). The radius of gyration (m) around x -axis is to be taken as $0.38B$, but a value calculated based upon the weight distribution according to the loading condition to be considered may be used.

2 In applying **4.4.2.4, Part 1**, the parameters (GM , z_G , etc.) required to calculate the dynamic pressure due to ballast water are to be the values in the ballast condition. The same parameters are to be applied where the dynamic pressure due to liquid other than ballast water, such as the pressure due to a fuel oil tank, is calculated.

4.3 Loads to be Considered in Strength Assessment by Cargo Hold Analysis

4.3.1 General

4.3.1.1 General

1 The loads to be considered in strength assessment by cargo hold analysis specified in **Chapter 8** and **Chapter 8, Part 1** are also to be in accordance with the requirements of **4.3**.

2 Additional requirements for loads in the maximum load condition are to be in accordance with the requirements of **4.3.2**.

3 Additional requirements for loads in the harbour condition are to be in accordance with the requirements of **4.3.3**.

4 The loads in the 30-degree static heel condition are to be in accordance with the requirements of **4.3.4**.

5 The loads in the collision condition are to be in accordance with the requirements of **4.3.5**.

4.3.2 Maximum Load Condition

4.3.2.1 Loading Conditions

1 Loading conditions which affect structural response of each structures to be assessed significantly are to be considered appropriately from all possible loading conditions except those restricted by the loading manual.

2 The loading conditions to be considered are to be in accordance with the following (1) to (3). However, where restricting the loading conditions on sea-going in the loading manual, the corresponding loading conditions may not be considered.

(1) For cargo hold analysis in the midship part, the loading conditions are to be in accordance with **Table 4.3.2-1**.

(2) For cargo hold analysis of the aftmost cargo hold, the loading conditions are to be in accordance with **Table 4.3.2-2**.

(3) For cargo hold analysis of the foremost cargo hold, the loading conditions are to be in accordance with **Table 4.3.2-3**.

3 The ballast tanks adjacent to the empty cargo hold in the one-tank-empty condition (*See S2* in **Table 4.3.2-1**, **Table 4.3.2-2** and **Table 4.3.2-3**) are to be taken as being empty where the ballast tanks are designed as being partially loaded or empty, and are to be taken as being fully loaded where the ballast tanks are designed as being fully loaded. Where the ballast tanks are taken as being fully loaded, it is to be stated in the loading manual that the ballast tanks are to be fully loaded in loading conditions where one cargo tank is in the one-tank-empty condition.

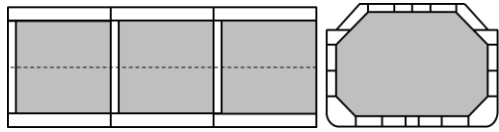
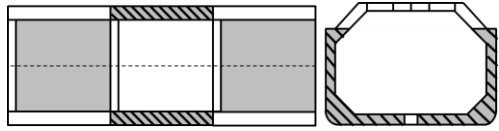
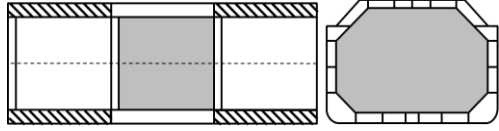
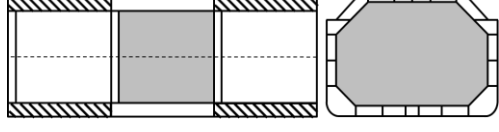
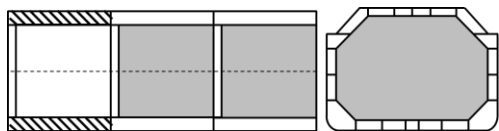
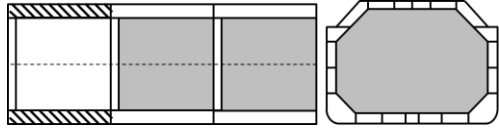
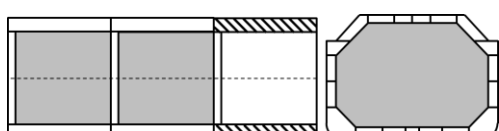
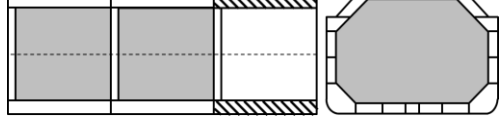

Table 4.3.2-1 Loading Conditions in Maximum Load Condition (Cargo Hold in the Midship Part)

Loading condition	Loading pattern		Draught	Vertical still water bending moment ⁽²⁾	Equivalent design wave
Full load condition	S1		T_{SC}	M_{SV_max}	HM-2/FM-2 PCL-2
				M_{SV_min}	HM-1/FM-1 BR-1P/-1S BP-1P/-1S AV-1P /-1S PCL -1
Condition loaded/unloaded in multiple ports ⁽¹⁾	S2		T_{1e_max}	M_{SV_max}	HM-2/FM-2 PCL -2
				M_{SV_min}	HM-1/FM-1 BR-1P/-1S BP-1P/-1S PCL -1
	S3		T_{2e_max}	M_{SV_max}	HM-2/FM-2 PCL -2
				M_{SV_min}	HM-1/FM-1 BR-1P/-1S BP-1P/-1S AV-1P /-1S PCL -1
	S4		T_{2e_min}	M_{SV_max}	HM-2/FM-2 PCL -2
				M_{SV_min}	HM-1/FM-1 BR-1P/-1S BP-1P/-1S AV-1P /-1S PCL -1
	S5		T_{1e_max}	M_{SV_max}	HM-2/FM-2 PCL -2
				M_{SV_min}	HM-1/FM-1 BR-1P/-1S BP-1P/-1S AV-1P /-1S PCL -1
S6		T_{1e_min}	M_{SV_max}	HM-2/FM-2 PCL -2	
			M_{SV_min}	HM-1/FM-1 BR-1P/-1S BP-1P/-1S AV-1P /-1S PCL -1	
S7		T_{1e_max}	M_{SV_max}	HM-2/FM-2 PCL -2	
			M_{SV_min}	HM-1/FM-1 BR-1P/-1S BP-1P/-1S AV-1P /-1S PCL -1	
S8		T_{1e_min}	M_{SV_max}	HM-2/FM-2 PCL -2	
			M_{SV_min}	HM-1/FM-1 BR-1P/-1S BP-1P/-1S AV-1P /-1S	

Loading condition	Loading pattern		Draught	Vertical still water bending moment ⁽²⁾	Equivalent design wave
					<i>PCL -1</i>
Ballast condition	<i>S9</i>		T_{BAL2}	M_{SV_max}	<i>HM-2/FM-2</i> <i>PCL -2</i>
				M_{SV_min}	<i>HM-1/FM-1</i> <i>BR-1P/-1S</i> <i>BP-1P/-1S</i> <i>PCL -1</i>
<p> : Liquid cargo : Ballast water : Ballast water (See 4.3.2.1-3) </p> <p>Notes:</p> <p>T_{1e_max}: Maximum draught designed for loaded/unloaded conditions in multiple ports which is the basis of the one-tank-empty condition (m), and the value are specified by the designer. The value is to be described in the loading manual as an operational restriction.</p> <p>T_{1e_min}: Minimum draught designed for loaded/unloaded conditions in multiple ports which is the basis of the one-tank-empty condition (m), and the value are specified by the designer. The value is to be described in the loading manual as an operational restriction.</p> <p>T_{2e_max}: Maximum draught designed for loaded/unloaded conditions in multiple ports which is the basis of the two-tank-empty condition (m), and the value are specified by the designer.</p> <p>T_{2e_min}: Minimum draught designed for loaded/unloaded conditions in multiple ports which is the basis of the two-tank-empty condition (m), and the value are specified by the designer.</p> <p>T_{BAL2}: Maximum draught in the ballast condition (m)</p>					
<p>(1) The radius of gyration (m) around the X-axis is taken as $0.38B$. However, the value calculated based on the weight distribution according to the loading condition to be considered may be used.</p> <p>(2) In the loading condition to be considered, instead of the vertical still water bending moment specified in the table, the maximum or maximum vertical still water bending moment that occurs after considering all possible physical combinations such as fully filled or empty consumable tank may be used.</p>					

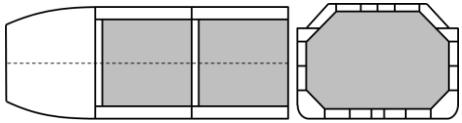
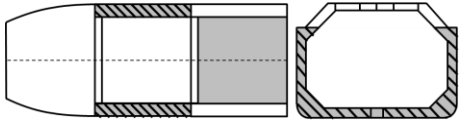
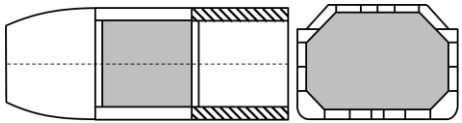
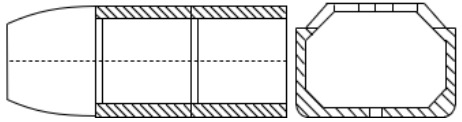
Table 4.3.2-2 Loading Conditions in Maximum Load Condition (Aftmost Cargo Hold)

Loading condition	Loading pattern		Draught	Vertical still water bending moment ⁽²⁾	Equivalent design wave
Full load condition	S1		T_{SC}	M_{SV_max}	HM-2/FM-2 PCL-2
				M_{SV_min}	HM-1/FM-1 BR-1P/-1S BP-1P/-1S PCL-1
Condition loaded/unloaded in multiple ports ⁽¹⁾	S2		T_{1e_max}	M_{SV_max}	HM-2/FM-2 PCL-2
				M_{SV_min}	HM-1/FM-1 BR-1P/-1S BP-1P/-1S PCL-1
	S4		T_{1e_min}	M_{SV_max}	HM-2/FM-2 PCL-2
				M_{SV_min}	HM-1/FM-1 BR-1P/-1S BP-1P/-1S PCL-1
Ballast condition	S9		T_{BAL2}	M_{SV_max}	HM-2/FM-2 PCL-2
				M_{SV_min}	HM-1/FM-1 BR-1P/-1S BP-1P/-1S PCL-1



: As specified in [Table 4.3.2-1](#).

Notes:



T_{1e_max} , T_{1e_min} , T_{BAL2} : As specified in [Table 4.3.2-1](#).

(1) The radius of gyration (m) around the X -axis is taken as $0.38B$. However, the value calculated based on the weight distribution according to the loading condition to be considered may be used.

(2) In the loading condition to be considered, instead of the vertical still water bending moment specified in the table, the maximum or maximum vertical still water bending moment that occurs after considering all possible physical combinations such as fully filled or empty consumable tank may be used.

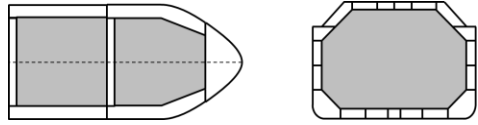
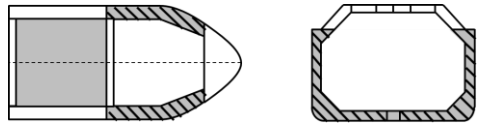
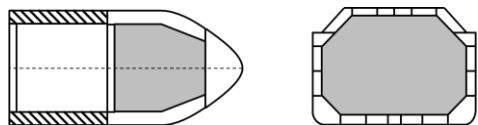
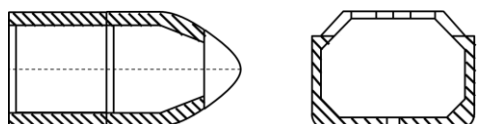
Table 4.3.2-3 Loading Conditions in Maximum Load Condition (Foremost Cargo Hold)

Loading condition	Loading pattern		Draught	Vertical still water bending moment ⁽²⁾	Equivalent design wave
Full load condition	S1		T_{SC}	M_{SV_max}	HM-2/FM-2 PCL-2
				M_{SV_min}	HM-1/FM-1 BR-1P/-1S BP-1P/-1S AV-1P /-1S PCL-1
Condition loaded/unloaded in multiple ports ⁽¹⁾	S2		T_{1e_max}	M_{SV_max}	HM-2/FM-2 PCL-2
				M_{SV_min}	HM-1/FM-1 BR-1P/-1S BP-1P/-1S PCL-1
	S4		T_{1e_min}	M_{SV_max}	HM-2/FM-2 PCL-2
				M_{SV_min}	HM-1/FM-1 BR-1P/-1S BP-1P/-1S AV-1P /-1S PCL-1
Ballast condition	S9		T_{BAL2}	M_{SV_max}	HM-2/FM-2 PCL-2
				M_{SV_min}	HM-1/FM-1 BR-1P/-1S BP-1P/-1S PCL-1

, , : As specified in [Table 4.3.2-1](#).

Notes:

T_{1e_max} , T_{1e_min} , T_{BAL2} : As specified in [Table 4.3.2-1](#).

(1) The radius of gyration (m) around the X -axis is taken as $0.38B$. However, the value calculated based on the weight distribution according to the loading condition to be considered may be used.

(2) In the loading condition to be considered, instead of the vertical still water bending moment specified in the table, the maximum or maximum vertical still water bending moment that occurs after considering all possible physical combinations such as fully filled or empty consumable tank may be used.

4.3.2.2 Wave Conditions

Loads based on the equivalent design waves specified in [Tables 4.3.2-4](#) are to be additionally considered.

Table 4.3.2-4 Concept of Equivalent Design Wave

Equivalent design wave		Heading	Typical Features	
<i>AV</i> ⁽¹⁾	<i>AV-1P</i>	Oblique sea	Port side: weather side up	Vertical acceleration at the centre of gravity of the cargo hold is maximum
	<i>AV-2P</i>	Oblique sea	Port side: weather side down	Vertical acceleration at the centre of gravity of the cargo hold is minimum
	<i>AV-1S</i>	Oblique sea	Starboard side: weather side up	Vertical acceleration at the centre of gravity of the cargo hold is maximum
	<i>AV-2S</i>	Oblique sea	Starboard side: weather side down	Vertical acceleration at the centre of gravity of the cargo hold is minimum
<i>PCL</i>	<i>PCL-1</i>	Head sea	Sagging condition	Hydrodynamic pressure at the centre line of the bottom is minimum
	<i>PCL-2</i>	Head sea	Hogging condition	Hydrodynamic pressure at the centre line of the bottom is maximum

(1) The wave *AV* is applied where the position of the centre of gravity of cargo hold to be assessed is $x/L_C > 0.6$.

4.3.2.3 External Pressure due to Seawater

In applying 4.6.2.4, Part 1, hydrodynamic pressure P_{exw} for the equivalent design wave *AV* and *PCL* specified in 4.3.2.4, Part 2-9 is to be additionally considered.

4.3.2.4 Internal Pressure due to Loaded Liquid

In applying 4.6.2.5, Part 1, the acceleration at any position with respect to the equivalent design wave *AV* and *PCL* is to be considered. The acceleration is to be in accordance with 4.3.2.5, Part 2-9.

4.3.2.5 Hull Girder Loads

1 In applying 4.6.2.10, Part 1, the vertical still water bending moment for the loading condition to be considered is to be in accordance with the requirements of 4.3.2.1.

2 In applying 4.6.2.10, Part 1, the coefficients C_{4v} and C_{4h} for equivalent design waves *AV* and *PCL* are to be in accordance with 4.3.2.6, Part 2-9.

4.3.3 Harbour Condition

4.3.3.1 Loading Conditions

In applying 4.6.3.1, Part 1, the loading conditions specified in the following (1) to (3) are to be considered. However, when restricting loading conditions in the harbour in the loading manual, the corresponding loading conditions may not be considered.

- (1) For cargo hold analysis in the midship part, the loading conditions are to be in accordance with Table 4.3.3-1.
- (2) For cargo hold analysis of the aft most cargo hold, the loading conditions are to be in accordance with Table 4.3.3-2.
- (3) For cargo hold analysis of the foremost cargo hold, the loading conditions are to be in accordance with Table 4.3.3-3.

Table 4.3.3-1 Loading Conditions in Harbour Condition (Cargo Hold in the Midship Part)

Loading condition	Loading pattern		Draught	Vertical bending moment in the harbour
Harbour conditions	P1		T_{SC}	M_{PT_max}
				M_{PT_min}
	P2		T_{P_max}	M_{PT_max}
				M_{PT_min}
	P3		T_{P_min}	M_{PT_max}
				M_{PT_min}
As specified in Table 4.3.2-1 .				
Notes: T_{P_max} : Maximum draught (m) in the conditions where cargo tank is empty in the harbour; the value determined by the designer. T_{P_min} : Minimum draught (m) in the conditions where cargo tank is loaded in the harbour; the value determined by the designer.				

Table 4.3.3-2 Loading Conditions in Harbour Condition (Aftmost Cargo Hold)

Loading condition	Loading pattern		Draught	Vertical bending moment in the harbour
Harbour condition	P1		T_{SC}	M_{PT_max}
				M_{PT_min}
	P2		T_{P_max}	M_{PT_max}
				M_{PT_min}
	P3		T_{P_min}	M_{PT_max}
				M_{PT_min}
As specified in Table 4.3.2-1 .				
Notes: T_{P_max}, T_{P_min} : As specified in Table 4.3.3-1 .				

Table 4.3.3-3 Loading Conditions in Harbour Condition (Foremost Cargo Hold)

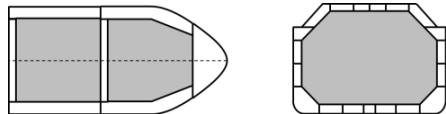
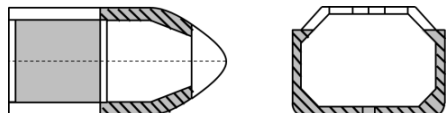
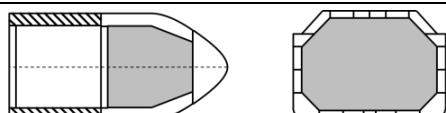
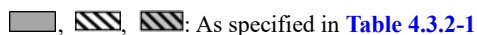
Loading condition	Loading pattern		Draught	Vertical bending moment in the harbour
Harbour conditions	P1		T_{SC}	M_{PT_max}
				M_{PT_min}
	P2		T_{P_max}	M_{PT_max}
				M_{PT_min}
	P3		T_{P_min}	M_{PT_max}
				M_{PT_min}
 : As specified in Table 4.3.2-1 .				
Notes:				
T_{P_max} , T_{P_min} : As specified in Table 4.3.3-1 .				

4.3.3.2 Internal Pressure due to Loaded Liquid

In applying [4.6.3.3, Part 1](#), where a design vapour pressure P_h that exceeds the design vapour pressure P_0 is given in accordance with the requirements of [4.13.2-3, Part N](#), the vapour pressure is to be considered. P_h is to be less than 70 kN/m^2 .

4.3.3.3 Hull Girder Loads

In applying [4.6.3.5, Part 1](#), the vertical bending moment in harbour for the loading condition to be considered is to be in accordance with the requirements of [4.3.3.1](#).

4.3.4 30-Degree Static Heel Condition

4.3.4.1 Loading Conditions

The standard loading condition is to be in accordance with [Table 4.3.4-1](#).

Table 4.3.4-1 Loading Conditions in 30-Degree Static Heel Condition

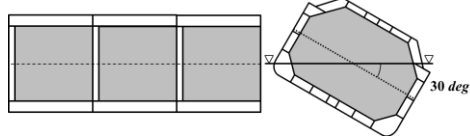
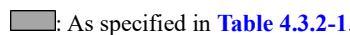
Loading condition	Loading pattern		Draught	Vertical bending moment
-	H1	In case of cargo hold in the midship part;  In cases of the aftmost and foremost cargo holds are to be the same as above.	T_{SC}	0
 : As specified in Table 4.3.2-1 .				
Notes :				
As for ships whose hull structure and cargo tank structure are asymmetrical, both the port down heel condition and the starboard down heel condition are to be considered.				

4.3.4.2 Others



Requirements other than the loading condition (wave conditions, external pressure, internal pressure and hull girder loads) are to be in accordance with the requirements of [4.3.4, Part 2-9](#).

4.3.5 Collision Condition

4.3.5.1 Loading Conditions

The standard loading condition is to be in accordance with [Table 4.3.5-1](#).

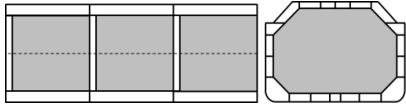
Table 4.3.5-1 Loading Conditions in Collision Condition

Loading condition	Loading pattern		Draught	Vertical bending moment
-	C1		T_{SC}	0
				

4.3.5.2 Other

Requirements other than the loading condition (wave conditions, external pressure, internal pressure and hull girder loads) are to be in accordance with the requirements of [4.3.5, Part 2-9](#).

4.4 Loads to be Considered in Fatigue

4.4.1 General

4.4.1.1 General

1 The loads to be considered for fatigue strength assessment specified in [Chapter 9](#) and [Chapter 9, Part 1](#) are also to be in accordance with the requirements of [4.4](#).

2 Additional requirements for loads in the cyclic load condition are to be in accordance with the requirements of [4.4.2](#).

4.4.2 Cyclic Load Condition

4.4.2.1 Loading Conditions

In applying [4.7.2.1, Part 1](#), the loading conditions specified in [Table 4.4.2-1](#) are to be considered. Where the difficulty occurs in matching the loading pattern with those specified in [Table 4.4.2-1](#) because of the arrangements of tanks, etc., the pattern based upon the loading condition described in loading manual may be considered.

Table 4.4.2-1 Loading Conditions in Cyclic Load Condition

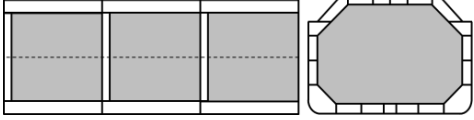
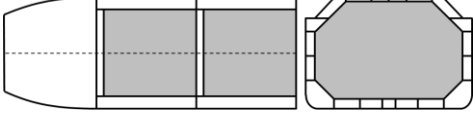
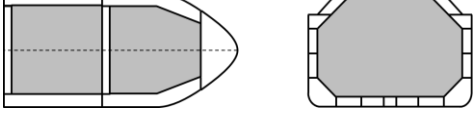
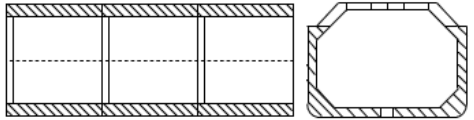
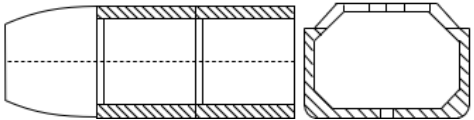
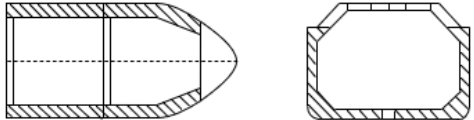
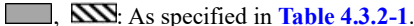
Loading condition	Loading pattern		Draught	Vertical still water bending moment	Equivalent design wave
Full load condition	F41	In case of cargo hold in the midship part 	Values at the time of departure described in the loading manual		HM / FM BR / BP AV / PCL
		In case of the aftmost cargo hold 			
		In case of the foremost cargo hold 			
Ballast condition	F42	In case of cargo hold in the midship part 	Values at the time of departure described in the loading manual		HM / FM BR / BP AV / PCL
		In case of the aftmost cargo hold 			
		In case of the foremost cargo hold 			
					

4.4.2.2 Wave Conditions

Loads based upon the equivalent design waves specified in Table 4.4.2-2 is to be additionally considered.

Table 4.4.2-2 Concept of Equivalent Design Wave

Equivalent design wave		Heading	Typical Features	
<i>AV</i> ⁽¹⁾	<i>AV-1P</i>	Oblique sea	Port side: weather side up	Vertical acceleration at the centre of gravity of the cargo hold is maximum
	<i>AV-2P</i>	Oblique sea	Port side: weather side down	Vertical acceleration at the centre of gravity of the cargo hold is minimum
	<i>AV-1S</i>	Oblique sea	Starboard side: weather side up	Vertical acceleration at the centre of gravity of the cargo hold is maximum
	<i>AV-2S</i>	Oblique sea	Starboard side: weather side down	Vertical acceleration at the centre of gravity of the cargo hold is minimum
<i>PCL</i>	<i>PCL-1</i>	Head sea	Sagging condition	Hydrodynamic pressure at the centre line of the bottom is minimum
	<i>PCL-2</i>	Head sea	Hogging condition	Hydrodynamic pressure at the centre line of the bottom is maximum
(1) The wave <i>AV</i> is applied where the position of the centre of gravity of cargo hold to be assessed is $x/L_C > 0.6$.				

4.4.2.3 External Pressure due to Seawater

In applying 4.7.2.4, Part 1, hydrodynamic pressure P_{exw} for the equivalent design wave *AV* and *PCL* specified in 4.4.2.4, Part 2-9 is to be additionally considered.

4.4.2.4 Internal Pressure due to Loaded Liquid

In applying 4.7.2.5, Part 1, the acceleration at any position with respect to the equivalent design wave *AV* and *PCL* is to be considered. The acceleration is to be in accordance with 4.4.2.5, Part 2-9.

4.4.2.5 Hull Girder Loads

1 In applying 4.7.2.10, Part 1, the vertical still water bending moment for the loading condition to be considered is to be in accordance with the requirements of 4.4.2.1.

2 In applying 4.7.2.10, Part 1, the coefficients C_{4v} and C_{4h} for equivalent design waves *AV* and *PCL* are to be in accordance with 4.4.2.6, Part 2-9.

4.5 Loads to be Considered in Additional Structural Requirements

4.5.1 General

4.5.1.1 General

1 The loads to be considered for the additional structural requirements specified in Chapter 10 are also to be in accordance with the requirements of 4.5.

2 The loads to be considered for the strain control of the inner hull structural members required by the system designer are to be in accordance with the requirements of 4.5.2.

4.5.2 Loads to be Considered in Strain Control of Inner Hull Structural Members

4.5.2.1 Loading Conditions

The loading conditions to be considered are to be in accordance with the requirements of 4.3.2.

4.5.2.2 Wave Conditions

The loads based upon the equivalent design waves specified in Table 4.5.2-1 are to be considered.

Table 4.5.2-1 Concept of Equivalent Design Wave

Equivalent design wave		Heading	Typical Features	
FMT	FMT-1	Head/following sea	Sagging condition	Wave conditions that maximise the strain of the inner bottom
	FMT-2	Head/following sea	Hogging condition	Wave conditions that maximise the strain of the inner bottom

4.5.2.3 External Pressure due to Seawater

Hydrostatic pressure P_{exs} is to be in accordance with the requirements of 4.6.2.4, Part 1. Hydrodynamic pressure P_{exw} in the equivalent design wave FMT is specified in Table 4.5.2-2 and Fig. 4.5.2-1.

 Table 4.5.2-2 Hydrodynamic Pressure P_{exw} in Equivalent Design Wave FMT

	Hydrodynamic pressure P_{exw} (kN/m ²)		
	$z \leq T_{LC}$	$T_{LC} < z \leq T_{LC} + h_W$	$z > T_{LC} + h_W$
FMT-1	$P_{exw} = \max(-P_{FMT}, \rho g(z - T_{LC}))$	$P_{WL} - \rho g(z - T_{LC})$	0
FMT-2	$P_{exw} = \max(P_{FMT}, \rho g(z - T_{LC}))$		

Notes:

P_{FMT} : As given by the following formula:

$$P_{FMT} = 0.5C_{R_{FMT}}C_{NL_{FMT}}C_M C_{FMT1}H_{S_{FMT}}(P_{FMT1} + P_{FMT2} + P_{FMT3})$$

$C_{R_{FMT}}$: Coefficient, to be taken as 0.85.

$C_{NL_{FMT}}$: Coefficient considering nonlinear effects, to be taken as 0.9.

C_M : Coefficient for maximum wave height, to be taken as 1.9.

C_{FMT1} : Correction coefficient for regular wave height, as given by the following formula:

$$C_{FMT1} = 0.22L_C^{0.2}$$

$H_{S_{FMT}}$: Significant wave height (m), as given by the following formula but not to be less than 2.0.

$$H_{S_{FMT}} = -0.21T_{Z_{FMT}}^2 + 5.07T_{Z_{FMT}} - 15.7$$

$T_{Z_{FMT}}$: Average zero up-crossing wave period (s), as given by the following formula:

$$T_{Z_{FMT}} = 0.71 \sqrt{\frac{2\pi\lambda_{FMT}}{g}} + 2.5$$

λ_{FMT} : Wavelength (m) in the equivalent design wave under consideration, as given by the following formula:

$$\lambda_{FMT} = (1.13 + 0.12f_T)L_C C_{W_{LC}}$$

P_{FMT1} : As given by the following formula:

$$P_{FMT1} = \rho g \cdot \exp\left(\frac{2\pi}{\lambda_{FMT}}(z - T_{LC})\right)$$

P_{FMT2} : As given by the following formula:

$$P_{FMT2} = \rho g |R_{3_{FMT}}| \cdot (-1.0)$$

$R_{3_{FMT}}$: As given by the following formula:

$$R_{3_{FMT}} = 0.18$$

P_{FMT3} : As given by the following formula:

$$P_{FMT3} = -0.235\rho g \left(1 - \frac{C_{yB}}{2}\right)$$

C_{yB} : The ratio of the Y coordinate at the point where the load acts or where calculating the acceleration to B_{x1} , to be taken as the following formula. However, the value is not to exceed 1.0, and $C_{yB} = 0$ in the case of $B_{x1} = 0$.

$$C_{yB} = \frac{|2y|}{B_{x1}}$$

B_{x1} : Moulded breadth (m) at the waterline of the draught at the cross section under consideration. $B_{x1} = 0$ in case where cross section is located above the waterline.

P_{WL} : Hydrodynamic pressure (kN/m^2) at the waterline in the equivalent design wave to be considered, to be taken as:

For $y \geq 0$, the value of P_{exw} at $y = B_{x1}/2$ and $z = T_{LC}$

For $y < 0$, the value of P_{exw} at $y = -B_{x1}/2$ and $z = T_{LC}$

h_W : Water head (m) which is equivalent to the pressure at the waterline, to be taken as the following formula:

$$h_W = \frac{P_{WL}}{\rho g}$$

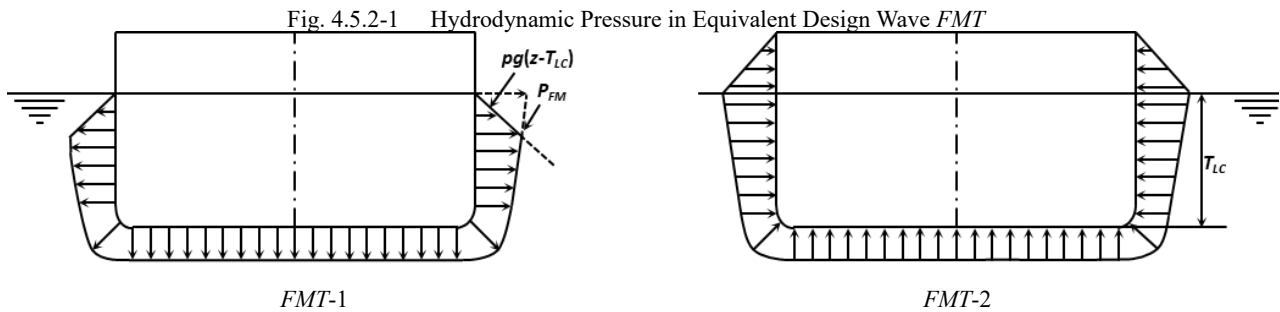

4.5.2.4 Internal Pressure due to Loaded Liquid

As for the internal pressure in the equivalent design wave *FMT*, P_{ls} specified in 4.6.2.5, Part 1 is to be considered.

4.5.2.5 Weight of the Hull Structure, etc.

The effect of the weight of the hull structure, etc. is to be considered.

4.5.2.6 Hull Girder Loads

The vertical bending moment M_{V-HG} ($kN-m$) and horizontal bending moment M_{H-HG} ($kN-m$) acting on the hull are to be in accordance with the following formulae:

$$M_{V-HG} = M_{SV} + C_{4v}M_{WV}$$

$$M_{H-HG} = C_{4h}M_{WH}$$

M_{SV} : As specified in the requirements of 4.3.2.

Table 4.5.2-3 Coefficients C_{4v} and C_{4h}

Equivalent design wave		M_{SV}	M_{WV-h} or M_{WV-s}		M_{WH}	
			C_{4v}	Condition	C_{4h}	Condition
<i>FMT</i>	<i>FMT-1</i>	Values for the loading conditions under consideration, as specified in the requirements of 4.3.2.	1.0	Sagging	0.0	—
	<i>FMT-2</i>		1.0	Hogging		—

Chapter 5 LONGITUDINAL STRENGTH

5.1 Hull Girder Ultimate Strength

5.1.1 Strength Criteria

5.1.1.1 Effect of Double Bottom Bending

In the assessment decision specified in [5.4.2.2 in Part 1](#), the coefficient γ_{DB} that takes into account the effect of double bottom bending is as follows.

$$\gamma_{DB} = 1.15$$

Chapter 7 STRENGTH OF PRIMARY SUPPORTING STRUCTURES

7.1 General

7.1.1 Primary Supporting Structure

7.1.1.1 Members Related to the Primary Support Structure

The scantlings of the members related to the primary support structure are to be determined in accordance with direct calculation based on the requirements of [Chapter 8](#).

Chapter 8 STRENGTH ASSESSMENT BY CARGO HOLD ANALYSIS

8.1 General

8.1.1 Overview

8.1.1.1 Structure and Overview of this Chapter

- 1 This Chapter specifies methods for strength assessment by cargo hold analysis in liquefied gas bulk carriers.
- 2 The structure and overview of this Chapter are shown in [Table 8.1.1-1](#).

Table 8.1.1-1 Overview of Chapter 8

Section	Title	Overview
8.1	General	Additional requirements related to the overview and application of this Chapter
8.2	Evaluation Areas and Members to be Assessed	Additional requirements related to evaluation area and members to be assessed
8.3	Structural Models	Additional requirements related to extent of model, members to be modelled, meshing, etc.
8.4	Boundary Conditions and Loads Conditions	Additional requirements related to the boundary conditions and loads conditions
8.5	Strength Assessment	Additional requirements related to strength assessment

8.1.2 Application

8.1.2.1 Ships to be Assessed

Ships that strength assessment by cargo hold analysis is required, which fall under [8.1.2.1-1\(2\), Part 1](#), are to be ships that L_C is 90 m or more.

8.2 Evaluation Area and Members to be Assessed

8.2.1 Evaluation Area

8.2.1.1 Evaluation Area and Target Holds

- 1 In applying [8.2.1.1-2\(1\), Part 1](#), the cargo hold in the midship part is as defined in [Fig. 8.2.1-1](#).
- 2 In applying [8.2.1.1-2\(3\), Part 1](#), the foremost cargo hold and the aftmost cargo hold are to be selected as the target hold. (See [Fig. 8.2.1-1](#))

Fig. 8.2.1-1 Target Hold

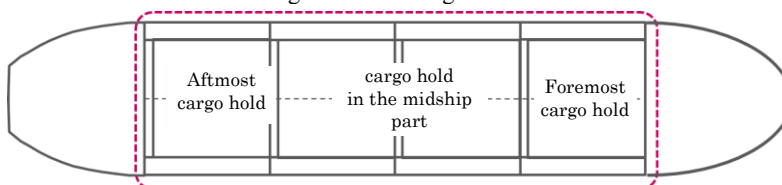

8.2.2 Members to be Assessed

8.2.2.1 Members to be Assessed in Maximum Load Condition, Harbour Condition and Testing Condition

In applying [8.2.2.1, Part 1](#), the structures and members to be assessed are to be as follows:

- (1) Double bottom structure (bottom shell, inner bottom plating, centre girder, side girder and floor)
- (2) Double side shell structure (side shell, longitudinal bulkhead, side stringer and side transverse)
- (3) Double deck structure (upper deck, inner deck, deck girder and deck transverse)
- (4) Bulkhead structure (transverse bulkhead and longitudinal bulkhead)
- (5) Other members and locations deemed necessary by the Society

8.2.2.2 Members to be Assessed in 30-degree Static Heel Condition

The structures and members to be assessed are to be in accordance with **8.2.2.1**.

8.2.2.3 Members to be Assessed in Collision Condition

The structures and members to be assessed are to be transverse bulkheads and the members within the region of 1 transverse spacing in the longitudinal direction from the transverse bulkheads.

8.3 Structural Models

8.3.1 General

8.3.1.1 Extent of Model

In applying **8.3.1.1, Part 1**, the model is, in principle, to represent three adjacent cargo holds with the target hold in the middle and the full depth and the full width of the holds are to be modelled.

8.3.1.2 Properties of Elements

Density of materials is to be adjusted in consideration of the weight of equipment such as unmodeled cargo pumps, piping, etc. and insulation.

8.4 Boundary Conditions and Loads Conditions

8.4.1 Boundary Conditions

8.4.1.1

In applying **8.5.1, Part 1**, the boundary conditions is to be in accordance with **8.4.1, Part 2-8**.

8.4.2 Loads Condition

8.4.2.1 Loads to be Considered

In applying **8.5.2, Part 1**, loads based also upon the additional requirements specified in **4.3** are to be considered.

8.4.2.2 Method of Applying Moments to the Structural Model

In applying **8.5.2, Part 1**, the requirements specified in **Table 8.4.2, Part 2-8** are to be followed.

8.5 Strength Assessment

8.5.1 Yield Strength Assessment

8.5.1.1 Criteria

The permissible yield utilisation factor λ_{yperm} for the 30-degree static heel condition and collision condition is to be in accordance with **Table 8.5.1-1**.

Table 8.5.1-1 Permissible Yield Utilisation Factor

30-degree static heel condition	Collision condition
1.0	$\frac{\sigma_Y}{235/K}$

8.5.2 Buckling Strength Assessment

8.5.2.1 Criteria

The permissible buckling usage factor η_{all} for the 30-degree static lateral inclination condition and the collision condition is to be taken as 1.0.

Chapter 9 FATIGUE

9.1 General

9.1.1 Application of Fatigue Requirements

9.1.1.1 Application

Ships with a length L_C of 90 m or more are to be assessed for fatigue strength based on the hot spot stresses obtained by simplified stress analysis in **9.3, Part 1** and the finite element analysis in **9.4, Part 1**.

9.2 Structural Details to be Assessed

9.2.1 Structural Details to be Assessed by Finite Element Analysis

9.2.1.1

1 Critical structural details to be assessed for fatigue strength by finite element analysis according to **9.4, Part 1**, are shown in **Table 9.2.1-1**.

2 Assessments are to be carried out for the midship, fore and aft cargo hold parts of the ship.

Table 9.2.1-1 Structural Details of Primary Members to be Assessed in the Hull Structure

No.	Important structural details of hull structure
1	Intersections between bilge hopper plating and inner bottom plating
2	Intersections between bilge hopper plating and inner longitudinal bulkhead
3	Intersections between inner longitudinal bulkhead and slanted inner deck
4	Intersections between slanted inner deck and inner deck
5	Intersections between upper deck and slanted trunk deck
6	Intersections between transverse bulkhead vertical girder and double bottom girder
7	Intersections between transverse bulkhead horizontal girder and side stringer
8	Intersections between transverse bulkhead vertical girder and deck girder
9	Fore and aft end of trunk deck structure

9.3 Loading Conditions and Fraction of Time to be Considered

9.3.1 General

9.3.1.1

1 Standard loading conditions and fraction of time are to be in accordance with **Table 9.3.1-1**.

2 Notwithstanding the requirements specified in -1 above, when considering loading conditions and fraction of time other than those in **Table 9.3.1-1**, it is necessary to consider appropriate combinations.

Table 9.3.1-1 Standard Loading Conditions and Fraction of Time

Loading conditions	Fraction of Time $\alpha_{(j)}$
--------------------	---------------------------------

Full load condition (homogeneous loading)	50 %
Ballast condition	50 %

9.4 Boundary Conditions and Load Conditions

9.4.1 Boundary Conditions

9.4.1.1

In applying [9.4.4.1, Part 1](#), the boundary conditions are to be in accordance with [8.4.1, Part 2-8](#).

9.4.2 Load Conditions

9.4.2.1 Method of Applying Moments to the Structural Model

In applying [9.4.4.2, Part 1](#), the method of applying moments to the structural model is to be in accordance with [8.4.2.2, Part 2-8](#). However, the vertical bending moment and horizontal bending moment ($kN-m$) specified in [Table 9.4.2-1](#) are to be used as M_{V-targ} , M_{H-targ} instead of those specified in [Table 8.4.2-1, Part 2-8](#).

Table 9.4.2-1 M_{V-targ} and M_{H-targ}

	Cyclic load condition
Vertical bending moment M_{V-targ}	M_{V-HG}
Horizontal bending moment M_{H-targ}	M_{H-HG}
Notes: M_{V-HG} , M_{H-HG} : Vertical bending moment and horizontal bending moment ($kN-m$) under cyclic load condition, to be in accordance with 4.7.2.10, Part 1 .	

Chapter 10 ADDITIONAL STRUCTURAL REQUIREMENTS

10.1 Special Requirements for Inner Hull Members

10.1.1 General

10.1.1.1

The requirements for strain control of inner hull structural members required by the system designer are specified in [10.1](#).

10.1.2 Strain Control of Inner Hull Structural Member

10.1.2.1

The inner hull structural members in cargo holds fitted with membrane tanks are to be in accordance with the following (1) or (2) corresponding to tank type. Requirements for strain control for tank types other than the following (1) and (2) are to be at the discretion of the Society.

- (1) Ships fitted with membrane tanks of GTT MARK III series or similar structures

$$\sigma_{st-gr} + \sigma_{dyn-gr} + \sigma_{loc-gr} \leq 185$$

σ_{st-gr} : Bending stress (N/mm^2) due to the maximum still water bending moment based on gross scantlings.

σ_{dyn-gr} : Bending stress (N/mm^2) due to the maximum wave bending moment corresponding to the exceedance probability of 10^{-8} in the North Atlantic wave environment, based on the gross scantlings.

σ_{loc-gr} : Maximum local bending stress (N/mm^2) due to local deflection of inner hull when considering alternate loading conditions, calculated by structural analysis using design condition *FMT* specified in [4.5.2](#), based on gross scantlings.

- (2) Ships with membrane tanks of the GTT NO96 series and similar structures

$$\sigma_{st-gr} + \sigma_{dyn-gr} \leq 120$$

σ_{st-gr} , σ_{dyn-gr} : As given in -1 above

10.2 Tank Structures for Sloshing

10.2.1 General

10.2.1.1 Application

1 For the members of hull structures acting as boundaries of cargo tanks which satisfy the following (1) to (3), the scantlings specified in this [10.2](#) are considered to be satisfied when obtained using the sloshing loads specified in [4.8.2.4, Part 1](#).

- (1) Cargo tanks with volumes of not less than $100 m^3$
- (2) Cargo tanks designed for possible loading at filling ratios of not less than 20 % and not more than 90 %
- (3) Where the period of longitudinal oscillation of cargo tanks is within the range of ± 20 % of pitch period and within ± 1.5 seconds from the same period, and where the period of transverse oscillation of cargo tanks is within the range of ± 20 % of roll period and within ± 1.5 seconds from the same period.

2 In applying -1(3) above, where only one of the conditions is applicable, only the sloshing load due to the relevant ship motion need be considered.

3 In applying -1(3) above, the tank natural periods are to be calculated for each 10 % of the filling ratio, and only the sloshing load due to the filling ratio corresponding to the conditions of -1(3) above need be considered.

10.2.1.2 Scantling Approach

The required scantlings specified in this [10.2](#) are to be net scantlings.

10.2.2 Plates

10.2.2.1

The thickness of plates on which sloshing loads act is to be not less than the value obtained from the formula specified in [10.9.2, Part 1](#). Equivalent pressure is to be in accordance with [Table 10.2.2-1](#).

Table 10.2.2-1 Equivalent Pressure for Plate Panels

Members to be assessed	P_{slh}
<ul style="list-style-type: none"> - Transverse bulkheads - Tank top plates near transverse bulkheads 	$C_m P_{slh-p}$ (4.8.2.4-4(1), Part 1)
<ul style="list-style-type: none"> - Longitudinal bulkheads - Inner deck sloping plates - Bilge hopper plating 	$C_m P_{slh-r}$ (4.8.2.4-4(2), Part 1)
Notes: Numbers in parentheses indicate section number. C_m : Coefficient, to be taken as 0.85	

10.2.3 Stiffeners

10.2.3.1

The section modulus of stiffeners attached to plates on which sloshing loads act is to be not less than the value obtained from the formula specified in **10.9.3, Part 1**. Equivalent bending moments are to be in accordance with **Table 10.2.3-1**.

Table 10.2.3-1 Equivalent Bending Moment for Each Member to be Assessed

Member to be assessed	Stiffened system	M_{slh}
- Stiffeners attached to transverse bulkheads	Vertical	$C_m M_{slh-p}$ (4.8.2.4-5(1), Part 1)
	Horizontal	$C_m M_{slh-p}$ (4.8.2.4-5(2), Part 1)
<ul style="list-style-type: none"> - Stiffeners attached to longitudinal bulkheads - Stiffeners attached to inner deck sloping plates - Stiffeners attached to bilge hopper plating 	Longitudinal	$C_m M_{slh-r}$ (4.8.2.4-5(1), Part 1)
Notes: Numbers in parentheses indicate section number. C_m : Coefficient, to be taken as 0.85		

Contents

GUIDANCE FOR THE SURVEY AND CONSTRUCTION OF STEEL SHIPS	2
Part C HULL CONSTRUCTION AND EQUIPMENT	2
Part 2-1 CONTAINER CARRIERS	2
C10 ADDITIONAL STRUCTURAL REQUIREMENTS	2
C10.5 Special Requirements for Container Carriers Applying Extremely Thick Steel Plates	2
C14 EQUIPMENT	4
C14.2 Container Securing Systems	4
Part 2-7 TANKERS.....	5
C6 LOCAL STRENGTH.....	5
C6.1 Independent Prismatic Tanks	5
Part 2-9 SHIPS CARRYING LIQUEFIED GASES IN BULK (INDEPENDENT PRISMATIC TANKS OF TYPE A/B)	6
C1 GENERAL	6
C1.1 General.....	6
Part 2-11 SHIPS CARRYING LIQUEFIED GASES IN BULK (MEMBRANE TANKS).....	7
C1 GENERAL	7
C1.1 General.....	7

GUIDANCE FOR THE SURVEY AND CONSTRUCTION OF STEEL SHIPS**Part C HULL CONSTRUCTION AND EQUIPMENT****Part 2-1 CONTAINER CARRIERS****C10 ADDITIONAL STRUCTURAL REQUIREMENTS****C10.5 Special Requirements for Container Carriers Applying Extremely Thick Steel Plates****C10.5.1 Special Requirements for Container Carriers Applying Extremely Thick Steel Plates****C10.5.1.3 Measures for Prevention of Brittle Fracture**

1 The “Other measures deemed by the Society to be equivalent in effectiveness to brittle crack arrest designs” referred to in **Note (1)** in **Table 10.5.1-1** of **10.5.1.3, Part 2-1, Part C of the Rules**, refers to the case of implementing non-destructive testing specified in **M8.4.3-2, Part M of the Guidance** by ultrasonic flaw detection testing or the phased array ultrasonic flaw detection testing according to the *TOFD* method as specified in **8.4.3-8, Part M of the Rules**.

2 Where the measures specified in -1 above is applied, it may be considered as equivalent in effectiveness as measures specified in **(2)** and **(3)** in **10.5.1.4-6, Part 2-1, Part C of the Rules**.

C10.5.1.4 Brittle Crack Arrest Design

1 “Appropriate measures” described in **10.5.1.4-6 (3), Part 2-1, Part C of the Rules** refers to separating, in principle, the block-to-block butt joint of the hatch side coaming and the block-to-block butt joint of the strength deck by 300 mm or more.

2 In a case where detailed materials (including implementation methods and non-destructive testing procedures for a joint) indicating validity are submitted to the Society and approved as an alternative to -1 above, the alternative is to be in accordance to **(1)** or **(2)** below. In this case, the Society may request a brittle crack test to confirm the effectiveness of these measures.

(1) An arrest hole is to be provided at the lower end of the block-to-block butt joint of the hatch side coaming. In this case, special attention is to be paid to the fatigue strength around the arrest hole.

(2) An insert plate made of high arrest steel is to be inserted into the lower end of the block-to-block butt joint of the hatch side coaming, or embed it with weld metal having sufficient brittle crack arrest characteristics.

C10.5.1.5 Selection of Brittle Crack Arrest Steels

1 In **10.5.1.5-1, Part C of the Rules**, when the steels evaluated by an evaluation method other than that specified in **3.12, Part K of the Rules** are to be brittle crack arrest steels, technical documents showing the validity of the evaluation method and the brittle crack arrest properties equivalent to the *BCA6000* or *BCA8000* specified in **3.12, Part K of the Rules** are to be submitted to the Society for approval. If necessary, additional tests may be required.

2 An example of “partial penetration weld” specified in **10.5.1.5-3, Part 2-1, Part C of the Rules** is shown in **Fig. C10.5.1-1**. In this figure, the standard welding leg length is 5 mm and the standard root surface is 1/3 or more of the thickness *t_t* of the hatch side coaming.

Fig. C10.5.1-1 Example of Partial Penetration Weld Between Hatch Side Coaming and Upper Deck

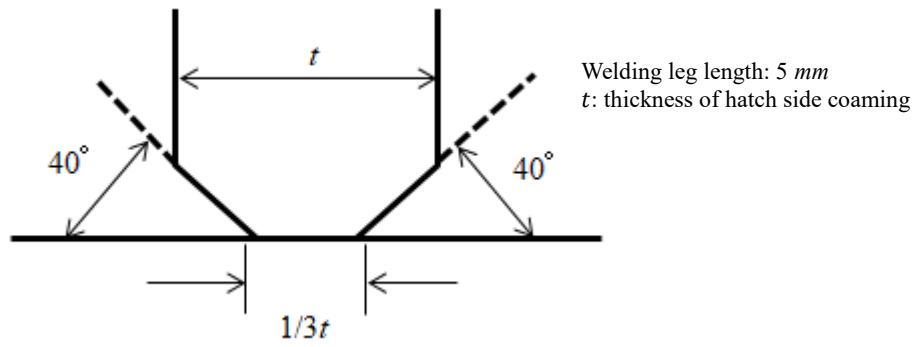

- 3 The “alternative weld details” specified in [10.5.1.5-3, Part C of the Rules](#) refers to a full penetration weld.

C14 EQUIPMENT

C14.2 Container Securing Systems

C14.2.3.3 Lashing Bridges and Container Posts

Where **14.2.3.3-2, Part 2-1, Part C of the Rules** is applied, the “Guidelines for Strength Assessment of Lashing Bridges” published separately by the Society is also to be applied.

Part 2-7 TANKERS

C6 LOCAL STRENGTH

C6.1 Independent Prismatic Tanks

C6.1.2 Supporting Structures in Independent Prismatic Tanks

C6.1.2.2 Material

The “material deemed appropriate by the Society” specified in [6.1.2.2-1, Part 2-7, Part C of the Rules](#), are a material such as resin or PolyWood.

Part 2-9 SHIPS CARRYING LIQUEFIED GASES IN BULK (INDEPENDENT PRISMATIC TANKS OF TYPE A/B)

C1 GENERAL

C1.1 General

C1.1.1 Application

C1.1.1.2 Relationship with Other Rules of the Society

As for the requirements of application of steels in [Table 1.1.1-1](#) of [1.1.1.2, Part 2-9, Part C of the Rules](#), each requirement of 46CFR154.170(b), 46CFR154.174, 46CFR154.176 is to be considered additionally where applying conformity certification of special requirements of USCG liquified gas bulk carriers.

Part 2-11 SHIPS CARRYING LIQUEFIED GASES IN BULK (MEMBRANE TANKS)

C1 GENERAL

C1.1 General

C1.1.1 Applications

C1.1.1.2 Relationship with Other Rules of the Society

As for the requirements of application of steels in [Table 1.1.1-1](#) of [1.1.1.2, Part 2-11, Part C of the Rules](#), each requirement of 46CFR154.170(b), 46CFR154.174, 46CFR154.176 is to be considered additionally where applying conformity certification of special requirements of USCG liquified gas bulk carriers.